

# **Technical Specifications**

*(Printed Version of Help)*

## **Agilent Technologies** **PNA Series Network Analyzers**



**Part Number: E8356-90028**  
**Printed in USA**  
**January 2003**

Supersedes December 2002

©Copyright 2000–2003 Agilent Technologies



Technical Specifications for the E8356A, E8357A, E8358A.....	1-1
Technical Specifications for the E8801A, E8802A, E8803A.....	2-1
Technical Specifications for the N3381A, N3381A, N3381A .....	3-1
Technical Specifications for the E8362A, E8363A, E8364A.....	4-1
Technical Specifications for the E8362B, E8363B, E8364B.....	5-1
Technical Specifications for the E8361A.....	6-1
Equations Used to Generate Uncertainty Curves.....	7-1



# 1 Technical Specifications for the E8356A, E8357A, E8358A

<b>Definitions</b> .....	1-3
<b>Corrected System Performance</b> .....	1-4
Table 1. System Dynamic Range.....	1-4
<b>Corrected System Performance with Type-N Connectors</b> .....	1-5
Table 2. Corrected System Performance With Type-N Device Connectors, 85032F Calibration Kit.....	1-5
Table 3. Corrected System Performance With Type-N Device Connectors, Option 015 With 85032F Calibration Kit.....	1-6
Table 4. Corrected System Performance With Type-N Device Connectors, 85092C Electronic Calibration Module.....	1-7
Table 5. Corrected System Performance With Type-N Device Connectors, Option 015 With 85092C Electronic Calibration Module .....	1-8
<b>Corrected System Performance with 3.5 mm Connectors</b> .....	1-9
Table 6. Corrected System Performance With 3.5 mm Device Connector Type, 85033E Calibration Kit.....	1-9
Table 7. Corrected System Performance With 3.5 mm Device Connector Type, Option 015 With 85033E Calibration Kit.....	1-10
Table 8. Corrected System Performance With 3.5 mm Device Connector Type, 85093C Electronic Calibration Module.....	1-11
Table 9. Corrected System Performance With 3.5 mm Device Connector Type, Option 015 With 85093C Electronic Calibration Module .....	1-12
<b>Corrected System Performance with 7-16 Connectors</b> .....	1-13
Table 10. Corrected System Performance With 7-16 Device Connector Type, 85038A Calibration Kit.....	1-13
Table 11. Corrected System Performance With 7-16 Device Connector Type, Option 015 With 85038A Calibration Kit .....	1-14
<b>Uncorrected Instrument Performance</b> .....	1-15
Table 12. Uncorrected Instrument Performance.....	1-15
<b>Test Port Output Characteristics (Source)</b> .....	1-15
Table 13. Test Port Output Frequency.....	1-15
Table 14. Test Port Output Power <sup>a</sup> .....	1-15
Table 15. Test Port Output Signal Purity.....	1-16
<b>Test Port and Receiver Input Characteristics</b> .....	1-16
Table 16. Test Port and Receiver Input Levels.....	1-16
Table 17. Test Port Input (Trace Noise).....	1-17
Table 18. Test Port Input (Reference Level and Stability).....	1-17
Table 19. Test Port Input (Dynamic Accuracy specification <sup>a</sup> ) .....	1-18
Table 20. Test Port Input (Group Delay) <sup>a</sup> .....	1-19
<b>General Information</b> .....	1-19
Table 21. System Bandwidths .....	1-19
Table 22. Front Panel Information .....	1-20
Table 23. Rear Panel Information .....	1-21
Table 24. Rear Panel Information (continued).....	1-22
Table 25. Analyzer Environment and Dimensions .....	1-23
<b>Measurement Throughput Summary</b> .....	1-24

Table 26. Typical Cycle Time <sup>a,b</sup> (ms) .....	1-24
Table 27. Cycle Time vs. IF Bandwidth <sup>a</sup> .....	1-24
Table 28. Cycle Time vs. Number of Points <sup>a</sup> .....	1-25
Table 29. Data Transfer Time <sup>a</sup> (ms) .....	1-26
Table 30. Recall and Sweep Speed <sup>a</sup> .....	1-27

<b>Specifications: Front-Panel Jumpers</b> .....	1-27
<b>E8356A, 57A, 58A, Standard - Port 1</b> .....	1-27
Receiver A Direct-Access Jumper .....	1-27
Reference Channel R1 Jumper .....	1-28
<b>E8356A, 57A, 58A, Standard - Port 2</b> .....	1-29
Receiver B Direct-Access Jumper .....	1-29
Reference Channel R2 Jumper .....	1-29
<b>E8356A, 57A, 58A, Option 015 - Port 1</b> .....	1-30
Receiver A Direct-Access Jumper .....	1-30
Reference Channel R1 Jumper .....	1-30
Port 1 Test-Port Jumper .....	1-31
<b>E8356A, 57A, 58A, Option 015 - Port 2</b> .....	1-31
Receiver B Direct-Access Jumper .....	1-31
Reference Channel R2 Jumper .....	1-32
Port 2 Test-Port Jumper .....	1-32
<b>E8356A, E8357A, and E8358A Simplified Test Set Block Diagram</b> .....	1-33
<b>E8356A, E8357A, and E8358A with Option 015 Simplified Test Set Block Diagram</b> ...	1-34

This is a complete list of the E8356A, E8357A, and E8358A network analyzer technical specifications.

- To optimize viewing of uncertainty curves, click the Maximize button.
- To view or print the PNA Series Data Sheet (a condensed version of the specifications), visit our web site at <http://www.agilent.com/find/pna>, select your analyzer model, and click on the link for the data sheet.
- The uncertainty curves contained in this document apply only to the setup conditions listed. Please download our free Uncertainty Calculator from [http://www.agilent.com/find/na\\_calculator](http://www.agilent.com/find/na_calculator) to generate the curves for your PNA setup. View the [equations](#) used to generate the uncertainty curves.

---

## Definitions

All specifications and characteristics apply over a 25 °C ±5 °C range (unless otherwise stated) and 90 minutes after the instrument has been turned on.

**Specification (spec.):** Warranted performance. Specifications include guardbands to account for the expected statistical performance distribution, measurement uncertainties, and changes in performance due to environmental conditions.

**Characteristic (char.):** A performance parameter that the product is expected to meet before it leaves the factory, but that is not verified in the field and is not covered by the product warranty. A characteristic includes the same guardbands as a specification.

**Typical (typ.):** Expected performance of an average unit which does not include guardbands. It is not covered by the product warranty.

**Nominal (nom.):** A general, descriptive term that does not imply a level of performance. It is not covered by the product warranty.

**Calibration:** The process of measuring known standards to characterize a network analyzer's systematic (repeatable) errors.

**Corrected (residual):** Indicates performance after error correction (calibration). It is determined by the quality of calibration standards and how well "known" they are, plus system repeatability, stability, and noise.

**Uncorrected (raw):** Indicates instrument performance without error correction. The uncorrected performance affects the stability of a calibration.

**Standard:** When referring to the analyzer, this includes no options unless noted otherwise.

## Corrected System Performance

The specifications in this section apply for measurements made with the E8356A, E8357A, and E8358A analyzer with the following conditions:

- 10 Hz IF bandwidth
- No averaging applied to data
- Environmental temperature of 25 °C ±5 °C, with < 1 °C deviation from calibration temperature
- Isolation calibration not omitted

**Note:** The uncertainty curves contained in these specifications apply only to the setup conditions listed. Please download our free Uncertainty Calculator from [http://www.agilent.com/find/na\\_calculator](http://www.agilent.com/find/na_calculator) to generate the curves for your PNA setup. View the equations used to generate the uncertainty curves.

**Table 1. System Dynamic Range**

Description	Specification (dB)	Characteristic (dB)
<b>Dynamic range<sup>a</sup> (at test port)</b>		
300 kHz to 25 MHz <sup>b</sup>	125	
25 MHz to 3 GHz <sup>b</sup>	128	
3 GHz to 6 GHz	118	
6 GHz to 9 GHz	113	
<b>Dynamic range<sup>c</sup> (at receiver input)</b>		
300 kHz to 25 MHz <sup>d</sup>		140
25 MHz to 3 GHz <sup>d</sup>		143
3 GHz to 6 GHz		133
6 GHz to 9 GHz		128

<sup>a</sup> The test port dynamic range is calculated as the difference between the test port rms noise floor and the source maximum output power. The effective dynamic range must take measurement uncertainties and interfering signals into account.

<sup>b</sup> May be limited to 100 dB at particular frequencies below 750 MHz due to spurious receiver residuals.

<sup>c</sup> The receiver input dynamic range is calculated as the difference between the receiver rms noise floor and the source maximum output power. The effective dynamic range must take measurement uncertainties and interfering signals into account. This set-up should only be used when the receiver input will never exceed its damage level. When the analyzer is in segment sweep mode, frequency segments can be defined with a higher power level when the extended dynamic range is required (i.e. the portion of the device's response with high insertion loss), and reduced power when receiver damage may occur (i.e. the portion of the device's response with low insertion loss).

<sup>d</sup> May be limited to 115 dB at particular frequencies below 750 MHz due to spurious receiver residuals.



# Corrected System Performance with Type-N Connectors

**Table 2. Corrected System Performance With Type-N Device Connectors, 85032F Calibration Kit**

Applies to the E8356A, E8357A, and E8358A analyzer, 85032F (Type-N, 50Ω) calibration kit, N6314A test port cable, and a full 2-port calibration. Also applies to the following conditions:

- IF bandwidth = 10 Hz
- No averaging applied to data
- Environmental temperature 25° ±5 °C, with < 1 °C deviation from calibration temperature
- Isolation calibration not omitted

Description	Specification (dB)			
	300 kHz to 1.3 GHz	1.3 GHz to 3 GHz	3 to 6 GHz	6 to 9 GHz
Directivity	49	46	40	38
Source Match	41	40	36	35
Load Match	49	45	39	37
Reflection Tracking	±0.011	±0.021	±0.032	±0.054
Transmission Tracking	±0.011	±0.019	±0.041	±0.051

## Transmission Uncertainty (Specifications)

### Magnitude

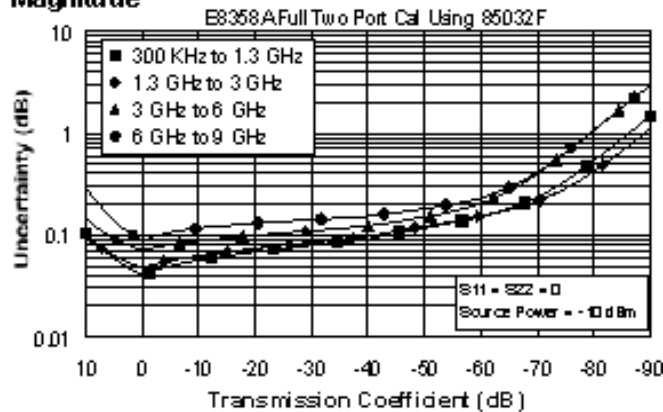

### Phase

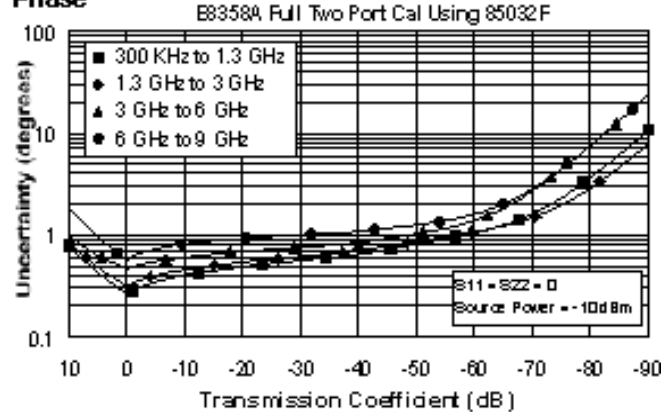

## Reflection Uncertainty (Specifications)

### Magnitude

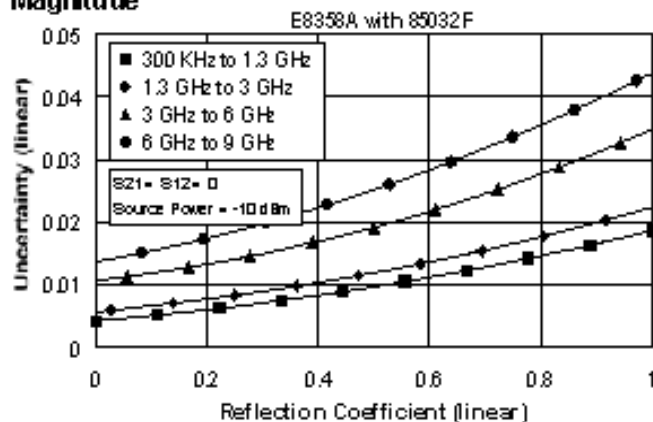

### Phase

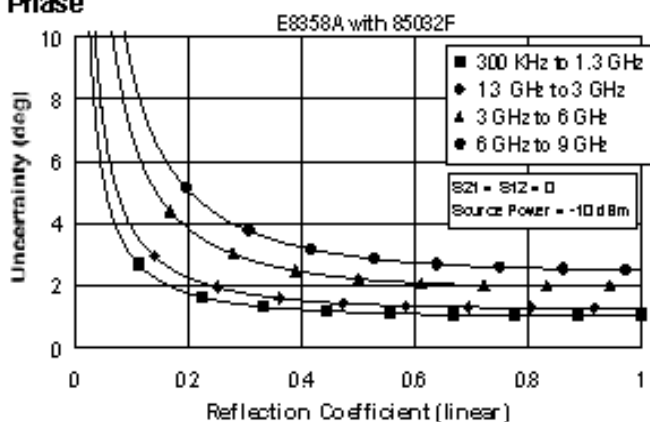

**Table 3. Corrected System Performance With Type-N Device Connectors, Option 015 With 85032F Calibration Kit**

Applies to the E8356A, E8357A, and E8358A analyzer with Option 015, 85032F (Type-N, 50Ω) calibration kit, N6314A test port cable, and a full 2-port calibration. Also applies to the following conditions:

- IF bandwidth = 10 Hz
- No averaging applied to data
- Environmental temperature 25° ±5 °C, with < 1 °C deviation from calibration temperature
- Isolation calibration not omitted

Description	Specification (dB)			
	300 kHz to 1.3 GHz	1.3 GHz to 3 GHz	3 to 6 GHz	6 to 9 GHz
Directivity	49	46	40	38
Source Match	41	40	36	35
Load Match	49	45	39	37
Reflection Tracking	±0.011	±0.021	±0.032	±0.054
Transmission Tracking	±0.011	±0.024	±0.052	±0.065

**Transmission Uncertainty (Specifications)**

**Magnitude**

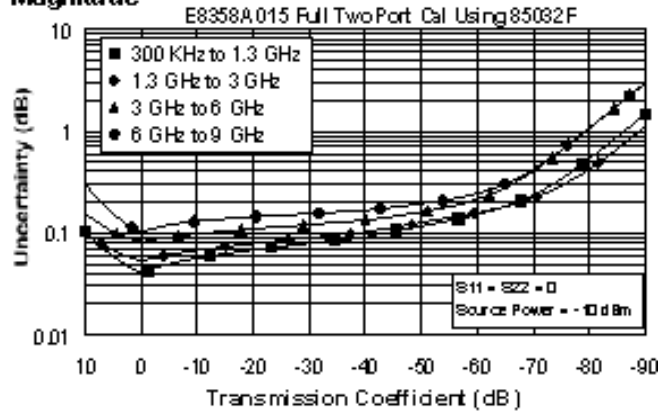

**Phase**

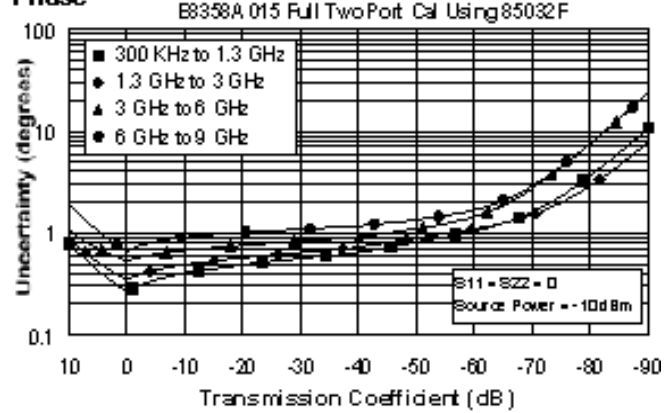

**Reflection Uncertainty (Specifications)**

**Magnitude**

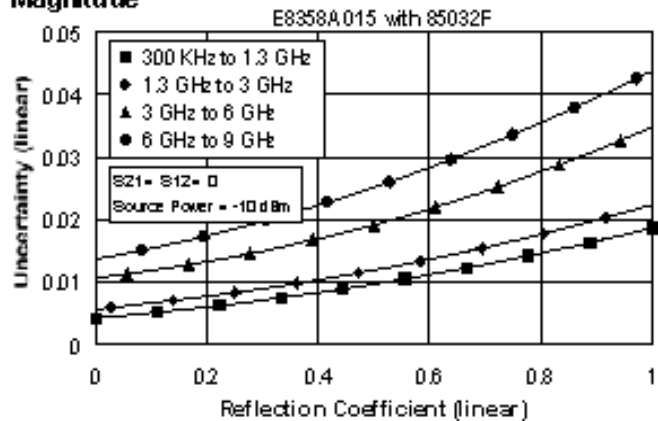

**Phase**

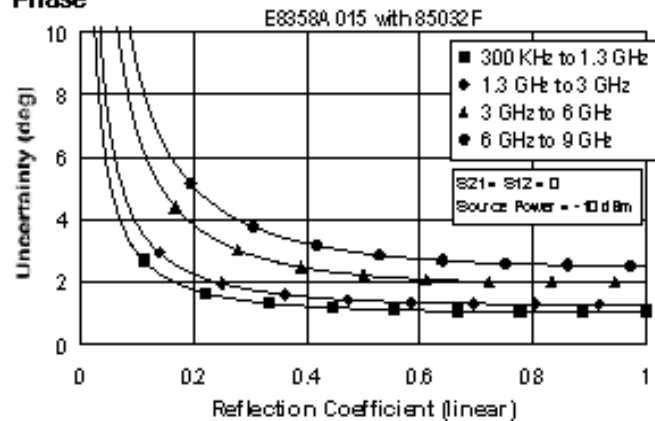

**Table 4. Corrected System Performance With Type-N Device Connectors, 85092C Electronic Calibration Module**

Applies to the E8356A, E8357A, and E8358A analyzer, 85092C (Type-N, 50Ω) electronic calibration (ECal) module, N6314A test port cable, and a full 2-port calibration. Also applies to the following conditions:

- IF bandwidth = 10 Hz
- No averaging applied to data
- Environmental temperature 25° ±5 °C, with < 1 °C deviation from calibration temperature
- Isolation calibration not omitted

Description	Specification (dB)			
	300 kHz to 1.3 GHz	1.3 GHz to 3 GHz	3 to 6 Hz	6 to 9 GHz <sup>a</sup>
Directivity	52	54	52	47
Source Match	45	44	41	36
Load Match	47	47	44	39
Reflection Tracking	±0.040	±0.040	±0.060	±0.070
Transmission Tracking	±0.039	±0.039	±0.068	±0.135

**Transmission Uncertainty (Specifications)**

**Magnitude**

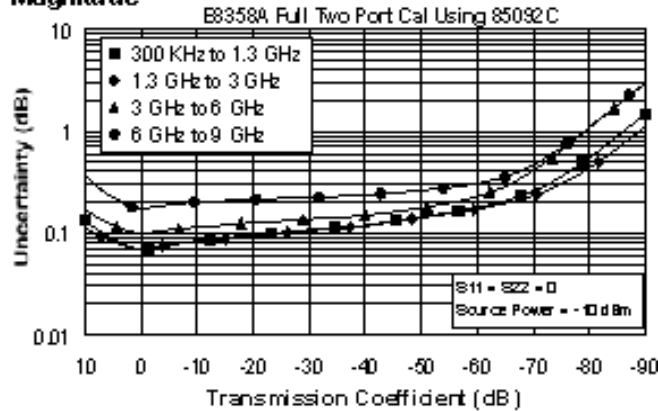

**Phase**

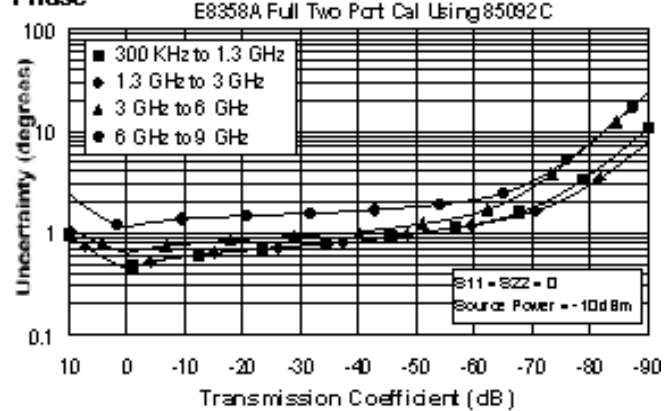

**Reflection Uncertainty (Specifications)**

**Magnitude**

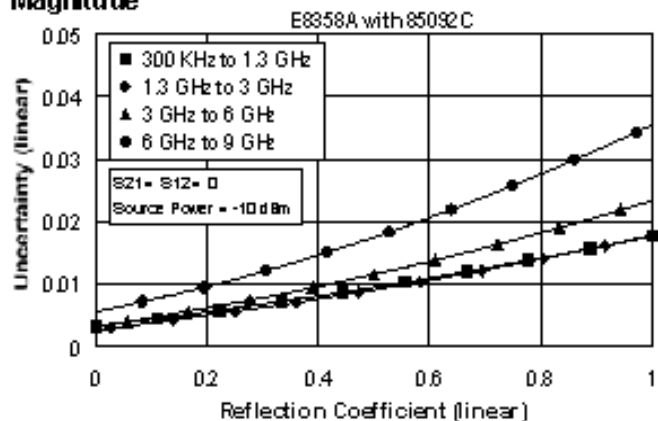

**Phase**

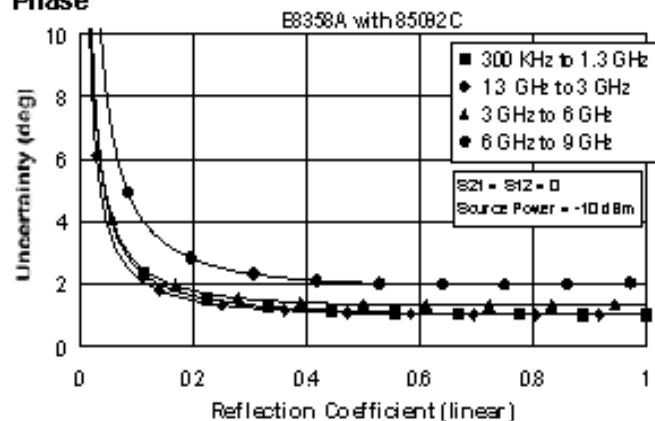

**Table 5. Corrected System Performance With Type-N Device Connectors, Option 015 With 85092C Electronic Calibration Module**

Applies to the E8356A, E8357A, and E8358A analyzer with Option 015, 85092C (Type-N, 50Ω) electronic calibration (ECal) module, N6314A test port cable, and a full 2-port calibration. Also applies to the following conditions:

- IF bandwidth = 10 Hz
- No averaging applied to data
- Environmental temperature 25° ±5 °C, with < 1 °C deviation from calibration temperature
- Isolation calibration not omitted

Description	Specification (dB)			
	300 kHz to 1.3 GHz	1.3 GHz to 3 GHz	3 to 6 GHz	6 to 9 GHz <sup>a</sup>
Directivity	52	54	52	47
Source Match	45	44	41	36
Load Match	47	47	44	39
Reflection Tracking	±0.040	±0.040	±0.060	±0.070
Transmission Tracking	±0.039	±0.039	±0.068	±0.135

**Transmission Uncertainty (Specifications)**

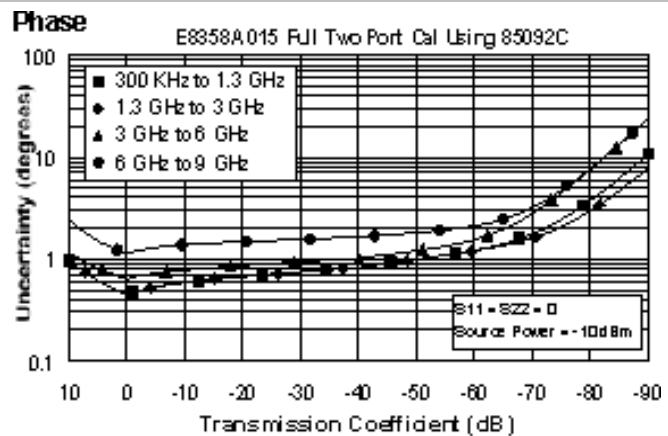
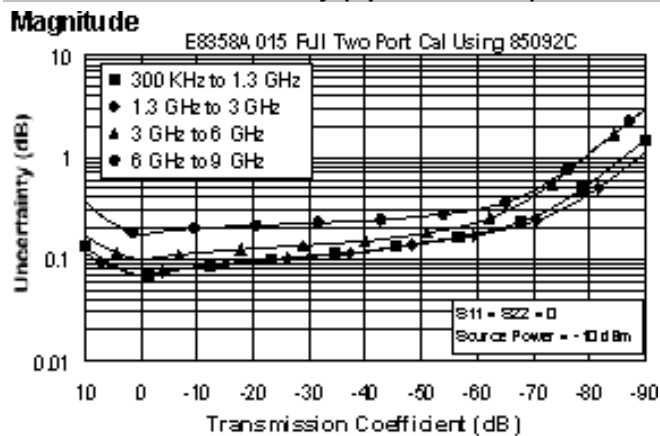

**Reflection Uncertainty (Specifications)**

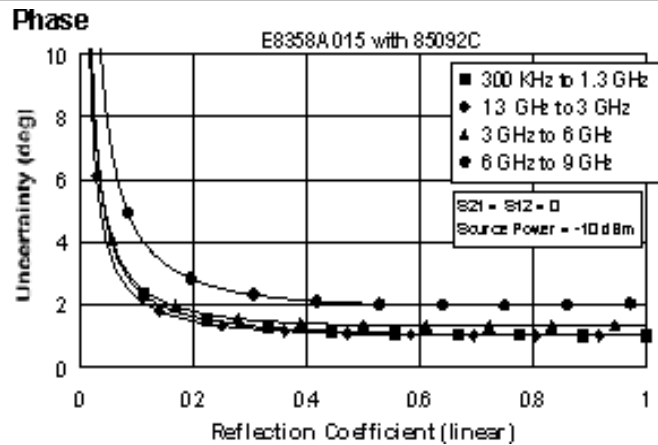
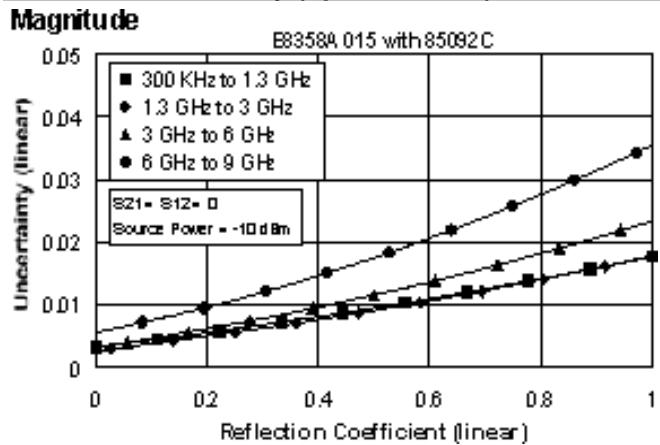

# Corrected System Performance with 3.5 mm Connectors

**Table 6. Corrected System Performance With 3.5 mm Device Connector Type, 85033E Calibration Kit**

Applies to the E8356A, E8357A, and E8358A analyzer, 85033E (3.5 mm, 50Ω) calibration kit, N6314A test port cable, and a full 2-port calibration. Also applies to the following conditions:

- IF bandwidth = 10 Hz
- No averaging applied to data
- Environmental temperature 25° ±5 °C, with < 1 °C deviation from calibration temperature
- Isolation calibration not omitted

Description	Specification (dB)			
	300 kHz to 1.3 GHz	1.3 GHz to 3 GHz	3 to 6 GHz	6 to 9 GHz
Directivity	46	44	38	38
Source Match	43	40	37	36
Load Match	46	44	38	38
Reflection Tracking	±0.006	±0.007	±0.009	±0.010
Transmission Tracking	±0.011	±0.020	±0.041	±0.047

## Transmission Uncertainty (Specifications)

### Magnitude

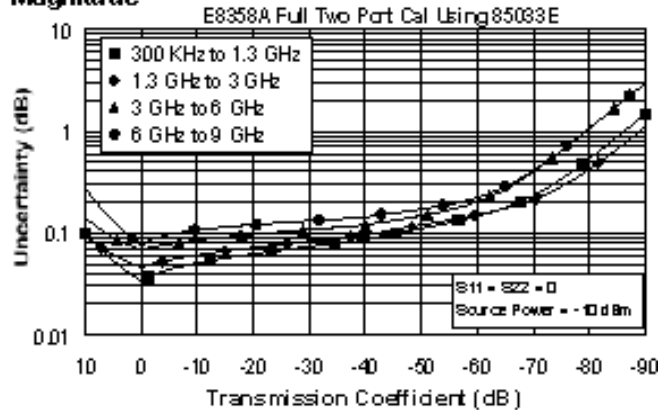

### Phase

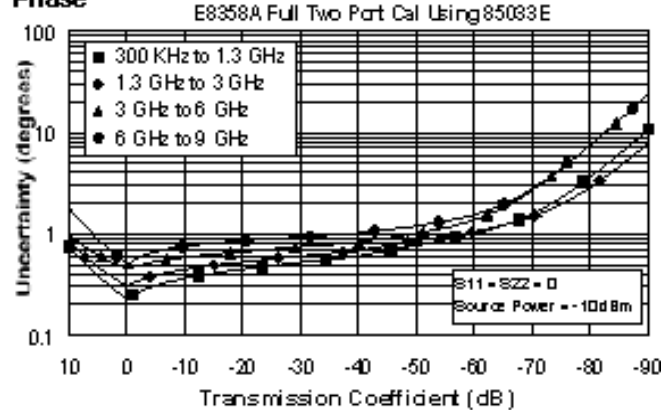

## Reflection Uncertainty (Specifications)

### Magnitude

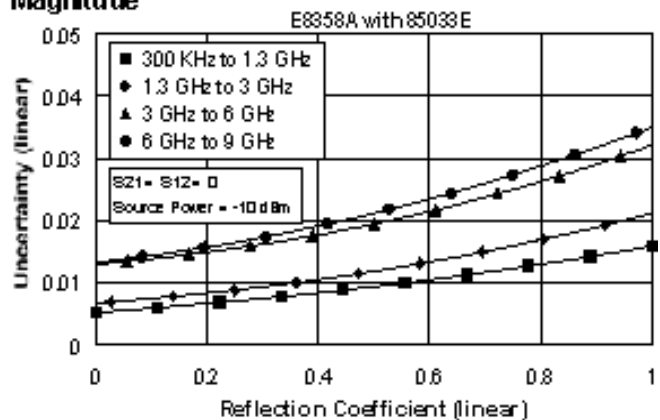

### Phase

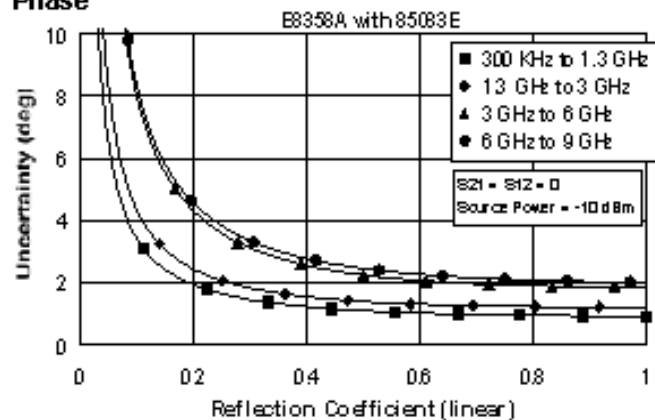

**Table 7. Corrected System Performance With 3.5 mm Device Connector Type, Option 015 With 85033E Calibration Kit**

Applies to the E8356A, E8357A, and E8358A analyzer with Option 015, 85033E (3.5 mm, 50Ω) calibration kit, N6314A test port cable, and a full 2-port calibration. Also applies to the following conditions:

- IF bandwidth = 10 Hz
- No averaging applied to data
- Environmental temperature 25° ±5 °C, with < 1 °C deviation from calibration temperature
- Isolation calibration not omitted

Description	Specification (dB)			
	300 kHz to 1.3 GHz	1.3 GHz to 3 GHz	3 to 6 GHz	6 to 9 GHz
Directivity	46	44	38	38
Source Match	43	40	37	36
Load Match	46	44	38	38
Reflection Tracking	±0.006	±0.007	±0.009	±0.010
Transmission Tracking	±0.011	±0.025	±0.052	±0.059

**Transmission Uncertainty (Specifications)**

**Magnitude**

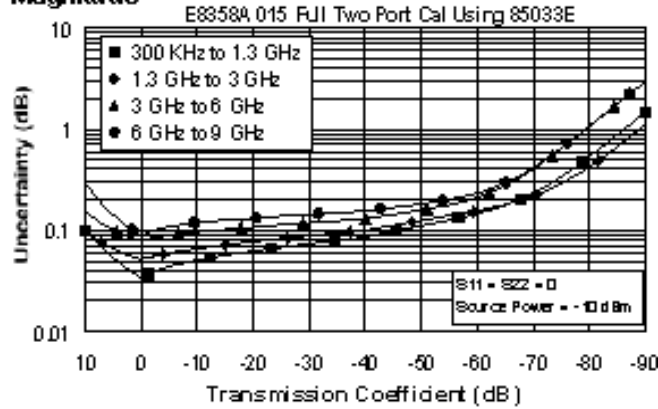

**Phase**

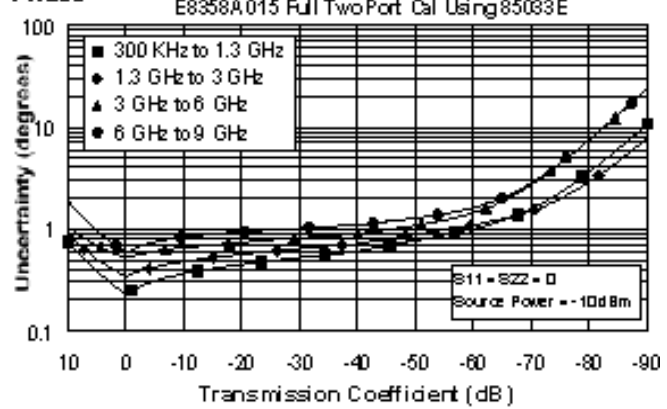

**Reflection Uncertainty (Specifications)**

**Magnitude**

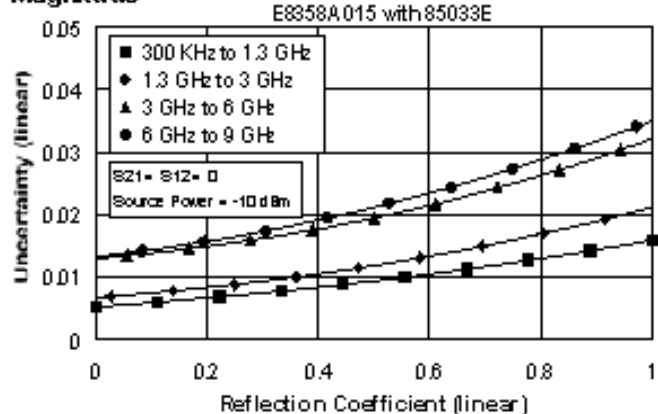

**Phase**

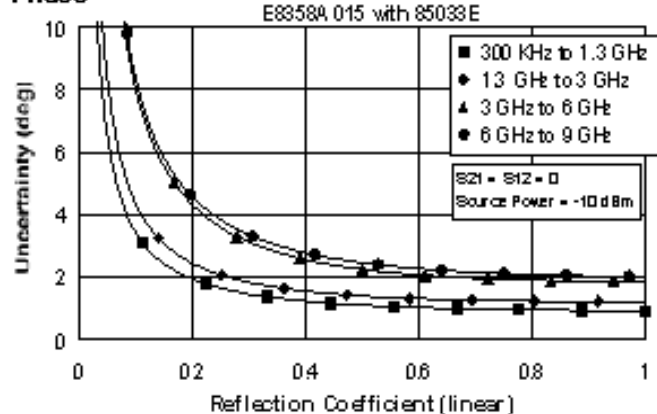

**Table 8. Corrected System Performance With 3.5 mm Device Connector Type, 85093C Electronic Calibration Module**

Applies to the E8356A, E8357A, and E8358A analyzer, 85093C (3.5 mm, 50Ω) electronic calibration (ECal) module, N6314A test port cable, and a full 2-port calibration. Also applies to the following conditions:

- IF bandwidth = 10 Hz
- No averaging applied to data
- Environmental temperature 25° ±5 °C, with < 1 °C deviation from calibration temperature
- Isolation calibration not omitted

Description	Specification (dB)			
	300 kHz to 1.3 GHz	1.3 GHz to 3 GHz	3 to 6 GHz	6 to 9 GHz <sup>a</sup>
Directivity	52	52	51	47
Source Match	44	44	39	34
Load Match	47	47	44	40
Reflection Tracking	±0.030	±0.040	±0.050	±0.070
Transmission Tracking	±0.039	±0.049	±0.068	±0.116

**Transmission Uncertainty (Specifications)**

**Magnitude**

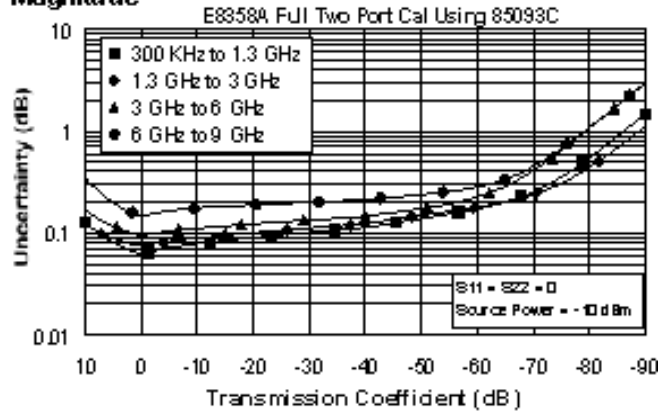

**Phase**

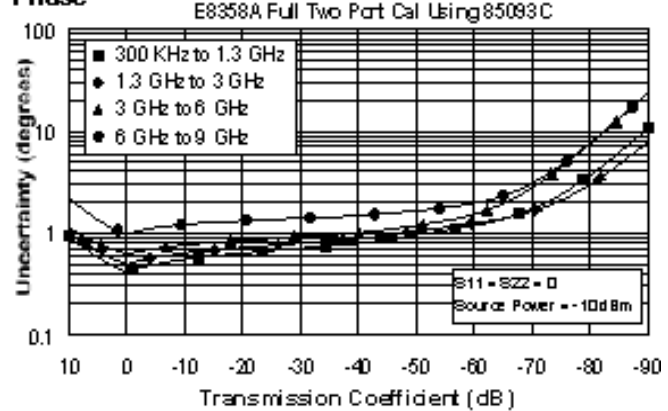

**Reflection Uncertainty (Specifications)**

**Magnitude**

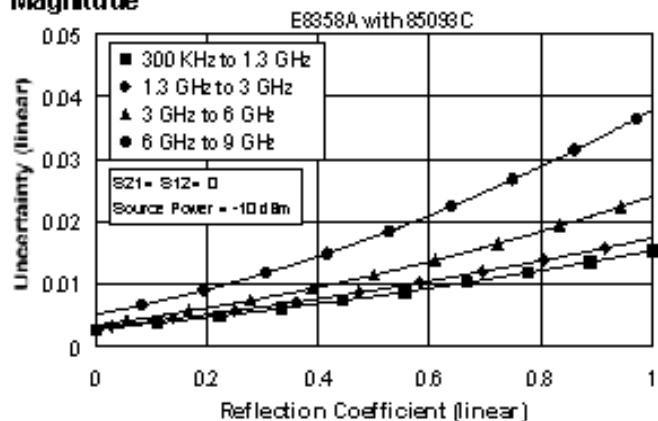

**Phase**

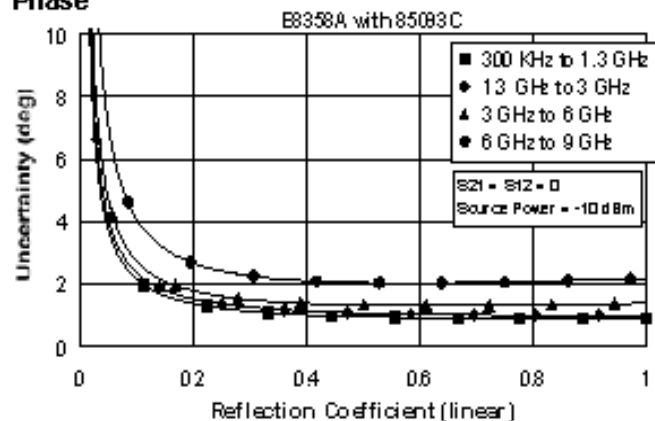

**Table 9. Corrected System Performance With 3.5 mm Device Connector Type, Option 015 With 85093C Electronic Calibration Module**

Applies to the E8356A, E8357A, and E8358A analyzer with Option 015, 85093C (3.5 mm, 50Ω) electronic calibration (ECal) module, N6314A test port cable, and a full 2-port calibration. Also applies to the following conditions:

- IF bandwidth = 10 Hz
- No averaging applied to data
- Environmental temperature 25° ±5 °C, with < 1 °C deviation from calibration temperature
- Isolation calibration not omitted

Description	Specification (dB)			
	300 kHz to 1.3 GHz	1.3 GHz to 3 GHz	3 to 6 GHz	6 to 9 GHz <sup>a</sup>
Directivity	52	52	51	47
Source Match	44	44	39	34
Load Match	47	47	44	40
Reflection Tracking	±0.030	±0.040	±0.050	±0.070
Transmission Tracking	±0.039	±0.049	±0.068	±0.116

**Transmission Uncertainty (Specifications)**

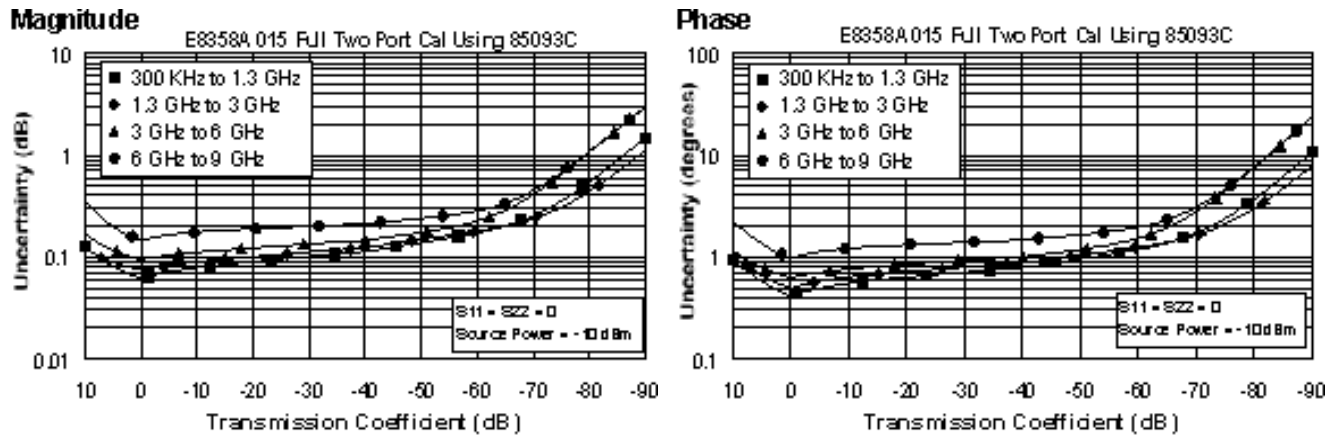

**Reflection Uncertainty (Specifications)**

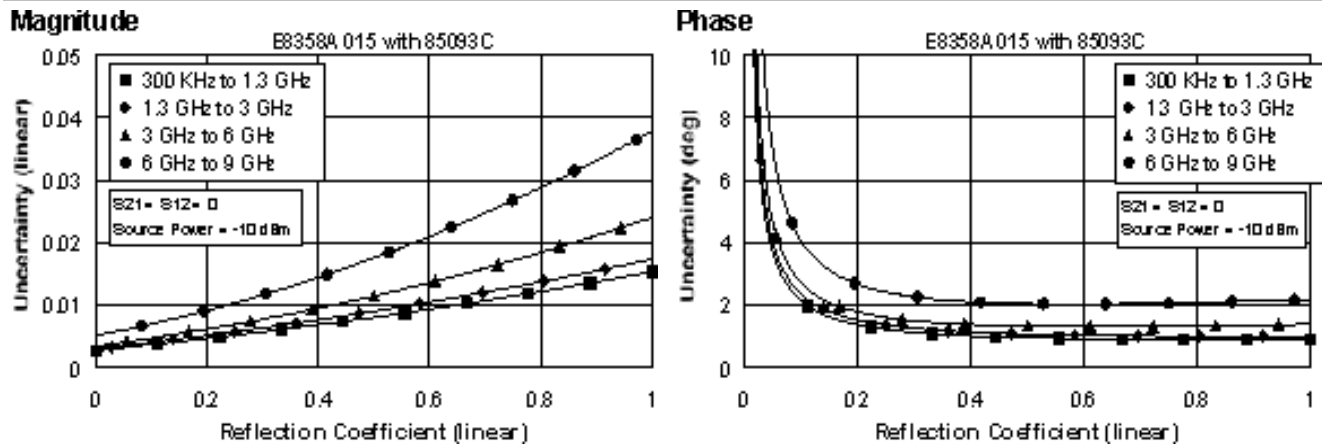



# Corrected System Performance with 7-16 Connectors

**Table 10. Corrected System Performance With 7-16 Device Connector Type, 85038A Calibration Kit**

Applies to the E8356A, E8357A, and E8358A analyzer, 85038A (7-16, 50Ω) calibration kit, N6314A test port cable, and a full 2-port calibration. Also applies to the following conditions:

- IF bandwidth = 10 Hz
- No averaging applied to data
- Environmental temperature 25° ±5 °C, with < 1 °C deviation from calibration temperature
- Isolation calibration not omitted

Description	Specification (dB)			
	300 kHz to 1.3 GHz	1.3 GHz to 3 GHz	3 to 6 GHz	6 to 9 GHza
Directivity	40	40	36	36
Source Match	37	37	34	34
Load Match	39	39	35	35
Reflection Tracking	±0.089	±0.089	±0.115	±0.115
Transmission Tracking	±0.022	±0.031	±0.059	±0.062

## Transmission Uncertainty (Specifications)

### Magnitude

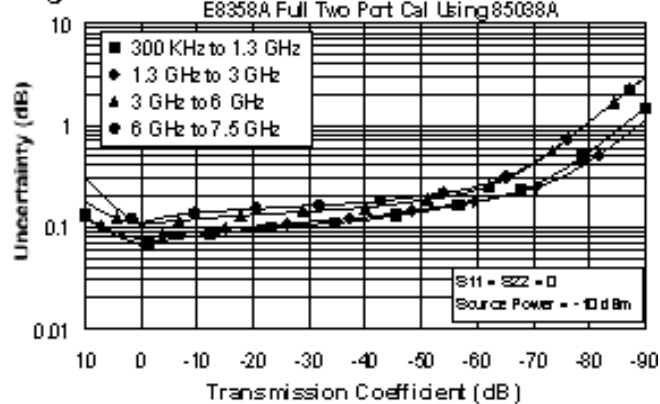

### Phase

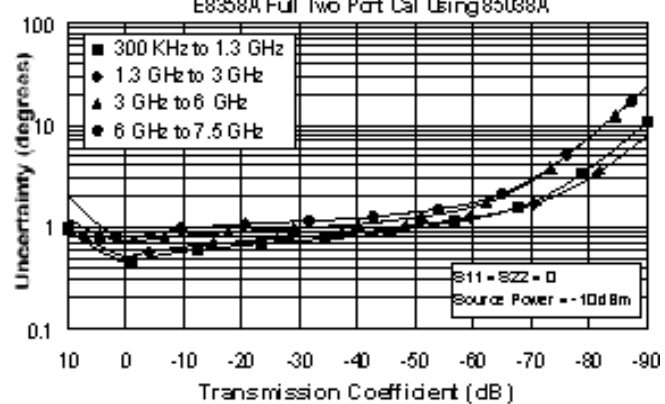

## Reflection Uncertainty (Specifications)

### Magnitude

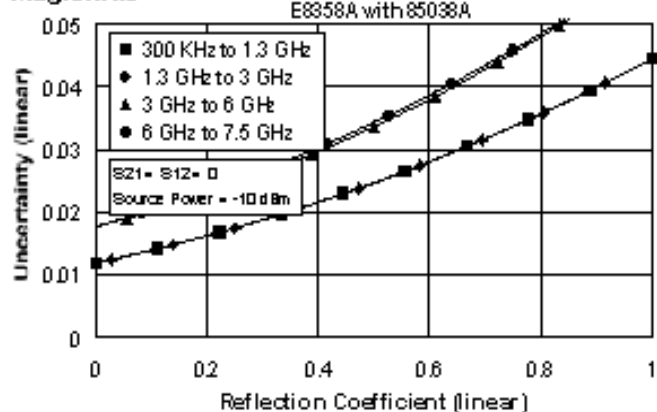

### Phase

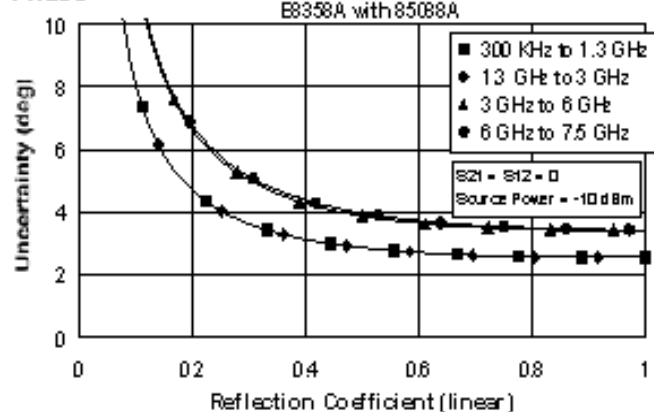

**Table 11. Corrected System Performance With 7-16 Device Connector Type, Option 015 With 85038A Calibration Kit**

Applies to the E8356A, E8357A, and E8358A analyzer with Option 015, 85038A (7-16, 50Ω) calibration kit, N6314A test port cable, and a full 2-port calibration. Also applies to the following conditions:

- IF bandwidth = 10 Hz
- No averaging applied to data
- Environmental temperature 25° ±5 °C, with < 1 °C deviation from calibration temperature
- Isolation calibration not omitted

Description	Specification (dB)			
	300 kHz to 1.3 GHz	1.3 GHz to 3 GHz	3 to 6 GHz	6 to 9 GHz <sup>a</sup>
Directivity	40	40	36	36
Source Match	37	37	34	34
Load Match	39	39	35	35
Reflection Tracking	±0.089	±0.089	±0.115	±0.115
Transmission Tracking	±0.022	±0.040	±0.075	±0.080

**Transmission Uncertainty (Specifications)**

**Magnitude**

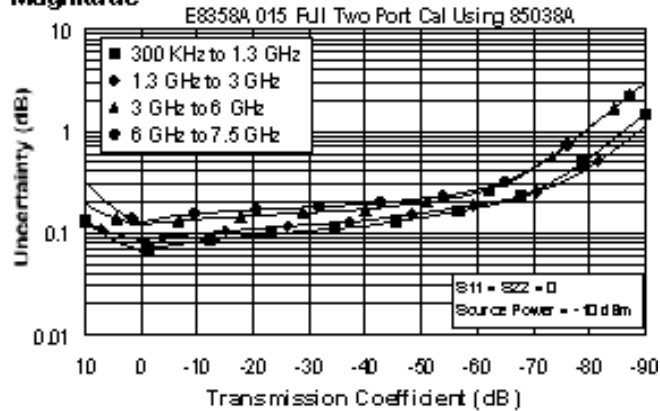

**Phase**

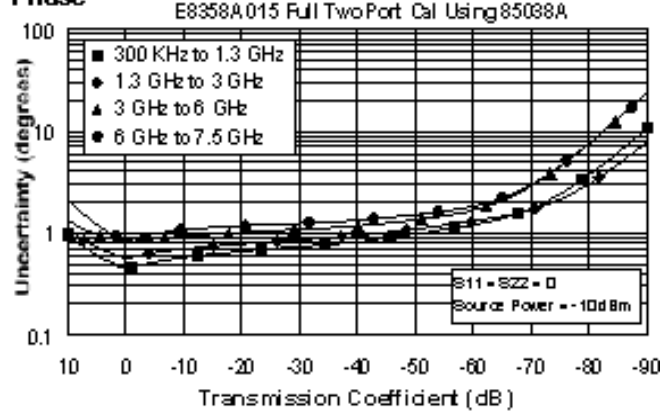

**Reflection Uncertainty (Specifications)**

**Magnitude**

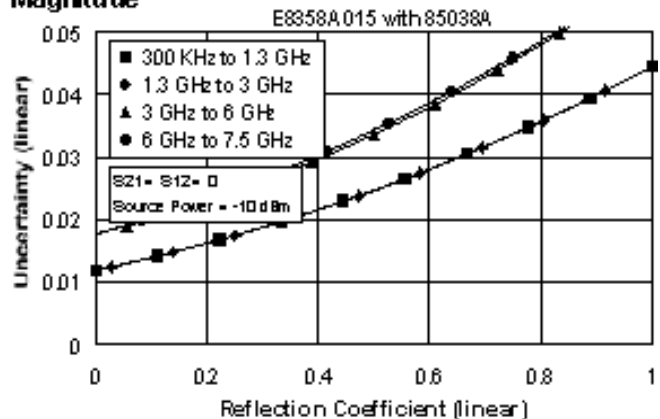

**Phase**

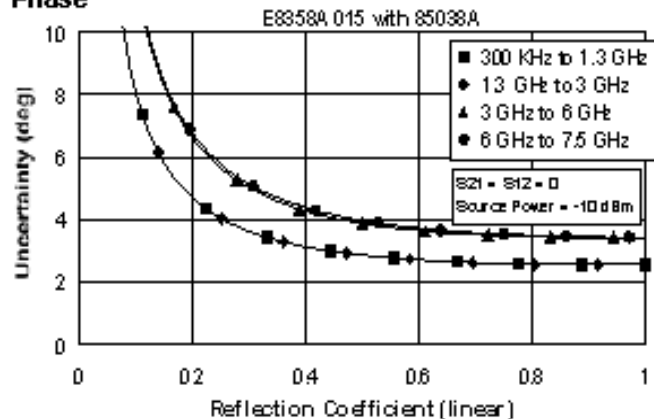

## Uncorrected Instrument Performance

Table 12. Uncorrected Instrument Performance

Description	Specification (dB)				
	300 kHz to 1 MHz	1MHz to 1.3 GHz	1.3 GHz to 3 GHz	3 GHz to 6 GHz	6 GHz to 9 GHz
Directivity	30	33	27	20	13
Source Match	20	20	17	15	14
Source Match (Opt. 015)	20	20	15	13	12
Load Match	20	20	17	15	15
Load Match (Opt. 015)	20	20	15	13	13
Reflection Tracking	±1.5	±1.5	±1.5	±2.5	±3.0
Transmission Tracking	±1.5	±1.5	±1.5	±2.5	±3.0

## Test Port Output Characteristics (Source)

Table 13. Test Port Output Frequency

Description	Specification	Supplemental Information
<b>Range</b>		
E8356A	300 kHz to 3.0 GHz	
E8357A	300 kHz to 6.0 GHz	
E8358A	300 kHz to 9.0 GHz	
<b>Resolution</b>	1 Hz	
<b>Source Stability</b>		±0.05 ppm, -0° to 40 °C, typical ±0.1 ppm/year, typical
<b>CW Accuracy</b>	±1 ppm	

Table 14. Test Port Output Power<sup>a</sup>

Description	Specification	Supplemental Information
<b>Level Accuracy</b>		
		Variation from 0 dBm in power range 0 (step attenuator at 0 dB) ±1.5dB below 10 MHz
300 kHz to 10 MHz	±1.5 dB	
10 MHz to 6 GHz	±1.0 dB	
6 GHz to 9 GHz	±2.0 dB	
<b>Level Linearity</b>		
		Variation from 0 dBm in power range 0
300 kHz to 9 GHz	±0.3 dB	-15 to +5 dBm
300 kHz to 1 MHz	±1.0 dB	+5 to +10 dBm
1 MHz to 6 GHz	±0.5 dB	+5 to +10 dBm
<b>Range<sup>b</sup></b>		
300 kHz to 6 GHz	-85 to +10 dBm	
6 GHz to 9 GHz	-85 to +5 dBm	
<b>Sweep Range</b>		
300 kHz to 6 GHz	25 dB	
6 GHz to 9 GHz	20 dB	
<b>Level Resolution</b>	0.01 dB	

<sup>a</sup> Source output performance on port 1 only. Port 2 output performance is typical.

<sup>b</sup> Power to which the source can be set and phase lock is assured.

**Table 15. Test Port Output Signal Purity**

Description	Specification	Supplemental Information
<b>Harmonics (2nd or 3rd)</b>		
at max output power (< 25 MHz)		< -25 dBc, typical
at max output power (25 MHz to 9 GHz)		< -25 dBc, characteristic <sup>a</sup>
at 0 dBm output		< -35 dBc, typical
at -10 dBm output		< -38 dBc, typical, in power range 0 (step attenuator at 0 dB)
<b>Non-harmonic Spurious</b>		
at max output		-30 dBc, typical for offset freq >1kHz
at -10 dBm output		-50 dBc, typical for offset freq >1kHz

<sup>a</sup> Typical below 25 MHz.

## Test Port and Receiver Input Characteristics

**Table 16. Test Port and Receiver Input Levels**

Description	Specification	Supplemental Information
<b>Maximum Test Port Input Level</b>		
<b>Test Ports 1 and 2:</b>		
300 kHz to 25 MHz	+10 dBm	< 0.6 dB compression
25 MHz to 3 GHz	+10 dBm	< 0.4 dB compression
3 GHz to 6 GHz	+10 dBm	< 0.7 dB compression
6 GHz to 9 GHz	+5 dBm	< 0.7 dB compression
<b>Damage Level</b>		
Test Port 1, 2		+30 dBm or ±30 VDC, typ.
R1, R2 IN		+15 dBm or ±5 VDC, typ.
A, B IN (standard)		+15 dBm or ±5 VDC, typ.
A, B IN (Opt. 015)		+15 dBm or ±0 VDC, typ.
Coupler IN (Opt. 015)		+33 dBm or ±0 VDC, typ.
<b>Test Port Noise Floor<sup>a</sup></b>		
300 kHz to 25 MHz <sup>b</sup>		
10 Hz IF Bandwidth	-115 dBm	
1 kHz IF Bandwidth	-95 dBm	
25 MHz to 3 GHz <sup>b</sup>		
10 Hz IF Bandwidth	-118 dBm	
1 kHz IF Bandwidth	-98 dBm	
3 GHz to 9 GHz		
10 Hz IF Bandwidth	≤ -108 dBm	
1 kHz IF Bandwidth	≤ -88 dBm	
<b>Receiver Noise Floor<sup>a</sup></b>		
300 kHz to 25 MHz <sup>c</sup>		
10 Hz IF Bandwidth	≤ -130 dBm	
1 kHz IF Bandwidth	≤ -110 dBm	
25 MHz to 3 GHz <sup>c</sup>		
10 Hz IF Bandwidth	≤ -133 dBm	
1 kHz IF Bandwidth	≤ -113 dBm	
6 GHz to 9 GHz		
10 Hz IF Bandwidth	≤ -123 dBm	
1 kHz IF Bandwidth	≤ -103 dBm	

<b>Crosstalk</b>		
		Between test ports 1 and 2, with short circuits at both ports
300 kHz to 1 MHz	<-120 dB	
1 MHz to 25 MHz	<-125 dB	
25 MHz to 3 GHz	<-128 dB	
3 GHz to 6 GHz	<-118 dB	
6 GHz to 9 GHz	<-113 dB	
<b>Maximum Receiver Input Level (A, B, R1, R2)</b>		
300 kHz to 6 GHz		-6 dBm, typical
6 GHz to 9 GHz		-11 dBm, typical
<b>Reference Input Level (R1, R2)<sup>d</sup></b>		
300 kHz to 9 GHz		-10 to -35 dBm, typical
<b>Maximum Coupler Input Level (Opt 015)</b>		
300 kHz to 9 GHz		+33 dBm, typical

<sup>a</sup> Total average (RMS) noise power calculated as the mean value of a linear magnitude trace expressed in dBm.

<sup>b</sup> May be limited to -90 dBm at particular frequencies below 750 MHz due to spurious receiver residuals.

<sup>c</sup> May be limited to -105 dBm at particular frequencies below 750 MHz due to spurious receiver residuals.

<sup>d</sup> Input level to maintain phase lock.

**Table 17. Test Port Input (Trace Noise)**

Description	Specification	Supplemental Information
<b>Trace Noise<sup>a</sup> Magnitude</b>		
1 kHz IF Bandwidth	< 0.002 dB rms	
10 kHz IF Bandwidth	< 0.005 dB rms	
<b>Trace Noise<sup>a</sup> Phase</b>		
1 kHz IF Bandwidth	< 0.010° rms	
10 kHz IF Bandwidth	< 0.035° rms	

<sup>a</sup> Trace noise is defined as a ratio measurement of a through or a full reflection, with the source set to 0 dBm.

**Table 18. Test Port Input (Reference Level and Stability)**

Description	Specification	Supplemental Information
<b>Reference Level Magnitude</b>		
Range	±200 dB	
Resolution	0.001 dB	
<b>Reference Level Phase</b>		
Range	±500°	
Resolution	0.01°	
<b>Stability Magnitude<sup>a</sup></b>		
300 kHz to 3 GHz		0.02 dB/°C, typical
3 GHz to 6 GHz		0.04 dB/°C, typical
6 GHz to 9 GHz		0.06 dB/°C, typical
<b>Stability Phase<sup>a</sup></b>		
300 kHz to 3 GHz		0.2°/°C, typical
3 GHz to 6 GHz		0.3°/°C, typical
6 GHz to 9 GHz		0.6°/°C, typical

<sup>a</sup> Stability is defined as a ratio measurement at the test port.

**Table 19. Test Port Input (Dynamic Accuracy specification<sup>a</sup>)**

Accuracy of the test port input power reading is relative to the reference input power level. Applies to input ports 1 and 2 with the following conditions:

- IF bandwidth = 10 Hz
- Environmental temperature  $25^{\circ} \pm 5^{\circ} \text{C}$ , with  $< 1^{\circ} \text{C}$  deviation from calibration temperature

300 kHz to 3 GHz

300 kHz to 3 GHz

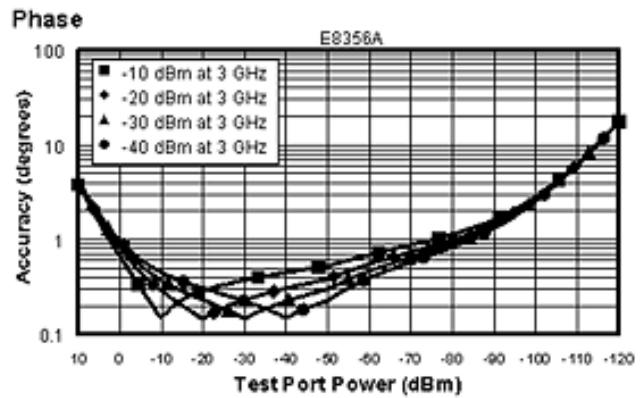
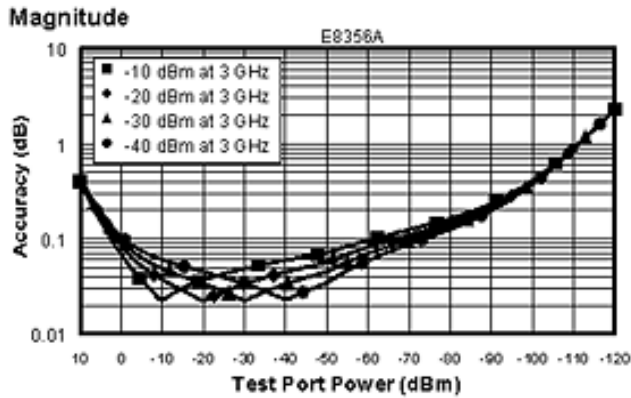

300 kHz to 6 GHz

300 kHz to 6 GHz

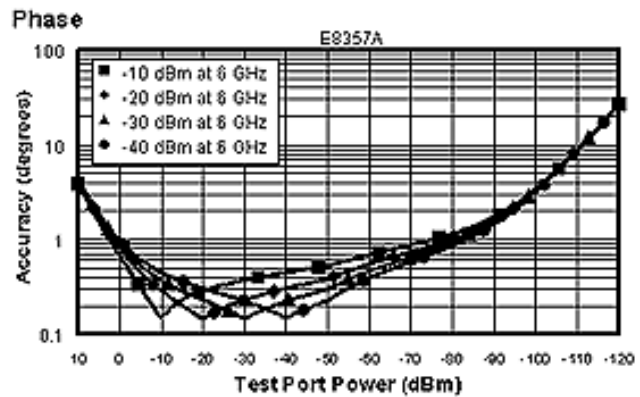
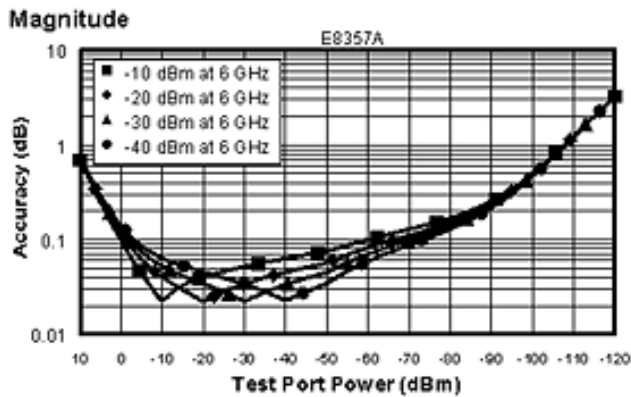

300 kHz to 9 GHz

300 kHz to 9 GHz

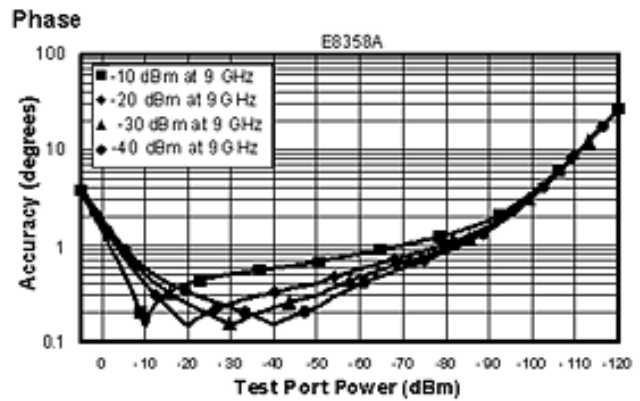
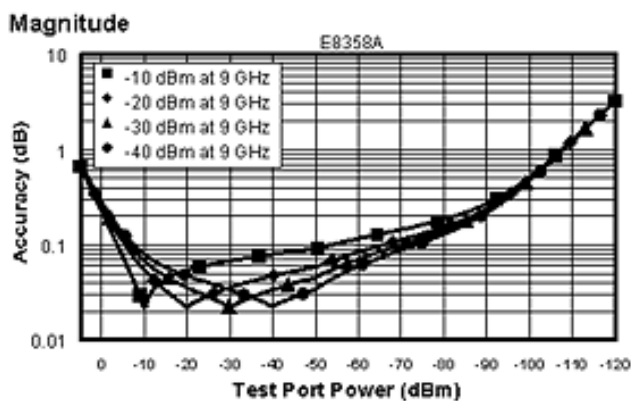

<sup>a</sup> Dynamic accuracy is verified with the following measurements:

- compression over frequency
- IF linearity at a single frequency of 1.195 GHz and a reference level of -20 dBm

**Table 20. Test Port Input (Group Delay)<sup>a</sup>**

Description	Specification	Supplemental Information
Aperture (selectable)	(frequency span)/(number of points -1)	
Maximum Aperture	20% of frequency span	
Range	0.5 x (1/minimum aperture)	
Maximum Delay		Limited to measuring no more than 180° of phase change within the minimum aperture.)
Accuracy		See graph below. Char.

The following graph shows group delay accuracy with type-N full 2-port calibration and a 10 Hz IF bandwidth. Insertion loss is assumed to be < 2 dB and electrical length to be ten meters.

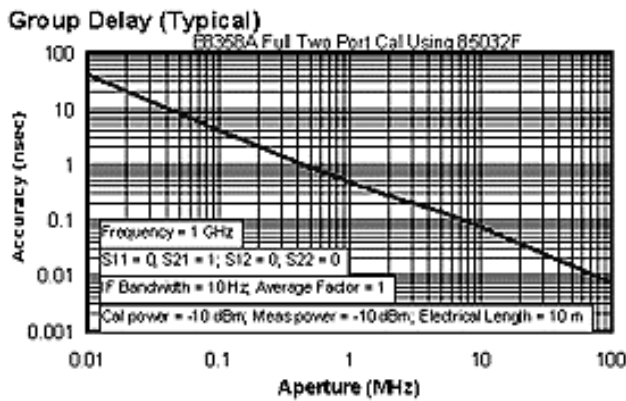

In general, the following formula can be used to determine the accuracy, in seconds, of specific group delay measurement:

$$\pm \text{Phase Accuracy (deg)} / [360 \times \text{Aperture (Hz)}]$$

Depending on the aperture and device length, the phase accuracy used is either incremental phase accuracy or worst case phase accuracy.

<sup>a</sup> Group delay is computed by measuring the phase change within a specified frequency step (determined by the frequency span and the number of points per sweep).

## General Information

**Table 21. System Bandwidths**

Description	Specification	Supplemental Information
<b>IF Bandwidth Settings</b>		
Range		1 Hz to 40 kHz in a 1, 2, 3, 5, 7, 10 sequence up to 30 kHz, 35 kHz, 40kHz, nominal

**Table 22. Front Panel Information**

<b>Description</b>	<b>Supplemental Information</b>
<b>RF Connectors</b>	
Type	Type-N, female; 50 $\Omega$ , nominal
Center Pin Protrusion	0.204 to 0.207 in., characteristic
<b>Probe Power</b>	
Connector	3-pin connector, male
Positive Supply	+15 VDC $\pm$ 2%, 400 mA, max, characteristic
Negative Supply	-12.6 VDC $\pm$ 5%, 300 mA, max, characteristic
<b>Display</b>	
Size	21.3 cm (8.4 in) diagonal color active matrix LCD; 640 (horizontal) X 480 (vertical) resolution
Refresh Rate	Vertical 59.83 Hz; Horizontal 31.41 Hz
<b>Display Range</b>	
Magnitude	$\pm$ 200 dB (at 20 dB/div), max
Phase	$\pm$ 180°, max
Polar	10 pUnits, min 1000 Units, max
<b>Display Resolution</b>	
Magnitude	0.001 dB/div, min
Phase	0.01°/div, min
<b>Marker Resolution</b>	
Magnitude	0.001 dB, min
Phase	0.01°, min
Polar	0.01 mUnit, min; 0.01°, min



**Table 23. Rear Panel Information**

<b>Description</b>	<b>Supplemental Information</b>
<b>Test Port Bias Input</b>	
Connector	BNC, female
Maximum Voltage	±30 VDC, typical
Maximum Current (no degradation in RF specifications)	±200 mA, typical
Maximum Current	±1 A, typical
<b>10 MHz Reference In</b>	
Connector	BNC, female
Input Frequency	10 MHz ± 1 ppm, typical
Input Level	-15 dBm to +20 dBm, typical
Input Impedance	200 Ω, nom.
<b>10 MHz Reference Out</b>	
Connector	BNC, female
Output Frequency	10 MHz ± 1 ppm, typical
Signal Type	Sine Wave, typical
Output Level	+10 dBm ± 4 dB into 50 Ω, typical
Output Impedance	50 Ω, nominal
Harmonics	<-40 dBc, typical
<b>VGA Video Output</b>	
Connector	15-pin mini D-Sub; Drives VGA compatible monitors
Devices Supported:	Resolutions:
Flat Panel (TFT)	1024 X 768, 800 X 600, 640 X 480
Flat Panel (DSTN)	800 X 600, 640 X 480
CRT Monitor	1280 X 1024, 1024 X 768, 800 X 600, 640 X 480
	Simultaneous operation of the internal and external displays is allowed, but with 640 X 480 resolution only. If you change resolution, you can only view the external display (internal display will "white out").
<b>Test Set IO</b>	25-pin D-Sub connector, available for external test set control
<b>Aux IO</b>	25-pin D-Sub connector, male, analog and digital IO
<b>Handler IO</b>	36-pin IDC D-ribbon socket connector; all input/output signals are default set to negative logic; can be reset to positive logic via GPIB command
<b>GPIB</b>	24-pin D-sub (Type D-24), female; compatible with IEEE-488.
<b>Parallel Port (LPT1)</b>	25-pin D-Sub connector, female; provides connection to printers or any other parallel port peripheral
<b>Serial Port (COM 1)</b>	9-pin D-Sub, male; compatible with RS-232
<b>USB Port</b>	
	Universal Serial Bus jack, Type A configuration (4 contacts inline, contact 1 on left); female
Contact 1	Vcc: 4.75 to 5.25 VDC, 500 mA, maximum
Contact 2	-Data
Contact 3	+Data
Contact 4	Ground
<b>LAN</b>	10/100BaseT Ethernet; 8-pin configuration; auto selects between the two data rates
<b>Line Power<sup>a, b</sup></b>	
Frequency at 110/115 V	50/60/400 Hz
Frequency at 230/240 V	50/60 Hz
Maximum Watts	350 W

<sup>a</sup> A third-wire ground is required.

<sup>b</sup> Power supply has a voltage autoswitching feature.

**Table 24. Rear Panel Information (continued)**

<b>Description</b>	<b>Supplemental Information</b>
<b>External AM Input</b>	
Description	Input provides low-frequency AM modulation to test port output signal, or shifts the test port output. Zero volts input gives the power level set by the instrument, a positive voltage gives a higher level, and a negative voltage gives a lower level.
Connector	BNC, female
Input Sensitivity	8 dB/V, typical
Bandwidth	1 kHz, typical
Input Impedance	1 k $\Omega$ , typical
<b>External Detector Input</b>	
Description	Input from an external, negative polarity diode detector provides ALC for a test port remote from instrument's front panel
Connector	BNC, female
Input Sensitivity	-500 mV yields approximately -3 dBm at detector's input, typical
Bandwidth	50 kHz, typical
Input Impedance	1 k $\Omega$ , nominal

**Table 25. Analyzer Environment and Dimensions**

<b>Description</b>	<b>Supplemental Information</b>		
<b>General Environmental</b>			
RFI/EMI Susceptibility	Defined by CISPR Pub. 11, Group 1, Class A, and IEC 50082-1		
ESD	Minimize using static-safe work procedures and an antistatic bench mat		
Dust	Minimize for optimum reliability		
<b>Operating Environment</b>			
Temperature	0 °C to +40 °C Instrument powers up, phase locks, and displays no error messages within this temperature range.		
Error-Corrected Temperature Range	25°C ± 5°C with less than 1°C deviation from calibration temp.		
Humidity	5% to 95% at +40 °C		
Altitude	0 to 4500 m (14,760 ft.)		
<b>Non-Operating Storage Environment</b>			
Temperature	-40 °C to +70 °C		
Humidity	0% to 90% at +65 °C (non-condensing)		
Altitude	0 to 15,240 m (50,000 ft.)		
<b>Cabinet Dimensions</b>			
	<b>Height</b>	<b>Width</b>	<b>Depth</b>
Excluding front and rear panel hardware and feet	222 mm 8.75 in	425 mm 16.75 in	426 mm 16.8 in
As shipped - includes front panel connectors, rear panel bumpers, and feet.	242 mm 9.5 in	425 mm 16.75 in	470 mm 18.5 in
As shipped plus handles	242 mm 9.5 in	458 mm 18 in	502 mm 19.75 in
As shipped plus rack-mount flanges	242 mm 9.5 in	483 mm 19 in	470 mm 18.5 in
As shipped plus handles and flanges	242 mm 9.5 in	483 mm 19 in	502 mm 19.75 in
<b>Weight</b>			
Net	24 kg (54 lb), nominal		
Shipping	32 kg (70 lb), nominal		

## Measurement Throughput Summary

Table 26. Typical Cycle Time<sup>a,b</sup> (ms)

	Number of Points			
	101	201	401	1601
<b>Start 1.8 GHz, Stop 2 GHz, 35 kHz IF bandwidth</b>				
Uncorrected, 1-port cal	9	12	18	54
2-Port cal	22	29	42	117
<b>Start 300 kHz, Stop 3 GHz, 35 kHz IF bandwidth</b>				
Uncorrected, 1-port cal	39	47	56	96
2-Port cal	80	101	121	204
<b>Start 300 kHz, Stop 9 GHz, 35 kHz IF bandwidth</b>				
Uncorrected, 1-port cal	51	57	64	103
2-Port cal	112	124	138	220

<sup>a</sup> Typical performance.

<sup>b</sup> Includes sweep time, retrace time and band-crossing time. Analyzer display turned off with DISPLAY:ENABLE OFF. Add 21 ms for display on. Data for one trace (S11) measurement.

Table 27. Cycle Time vs. IF Bandwidth<sup>a</sup>

Applies to the Preset condition (201 points, correction off) except for the following changes:

- CF = 1 GHz
- Span = 100 MHz
- Display off (add 21 ms for display on)

IF Bandwidth (Hz)	Cycle Time (ms) <sup>b</sup>
40,000	8
35,000	9
30,000	11
20,000	13
10,000	28
7000	36
5000	48
3000	72
1000	196
300	620
100	1875
30	8062
10	17877

<sup>a</sup> Typical performance.

<sup>b</sup> Cycle time includes sweep and retrace time.

**Table 28. Cycle Time vs. Number of Points<sup>a</sup>**

Applies to the Preset condition (35 kHz IF bandwidth, correction off) except for the following changes:

- CF = 1 GHz
- Span = 100 MHz
- Display off (add 21 ms for display on)

<b>Number of Points</b>	<b>Cycle Time (ms)<sup>b</sup></b>
3	4
11	4
51	5
101	6
201	9
401	16
801	29
1601	52

<sup>a</sup> Typical performance.

<sup>b</sup> Cycle time includes sweep and retrace time.

**Table 29. Data Transfer Time<sup>a</sup> (ms)**

	<b>Number of Points</b>			
	<b>51</b>	<b>201</b>	<b>401</b>	<b>1601</b>
<b>SCPI over GPIB</b>				
<b>(program executed on external PC)<sup>b</sup></b>				
32-bit floating point	3	7	12	43
64-bit floating point	4	12	22	84
ASCII	7	64	124	489
<b>SCPI over 100 Mbit/s LAN</b>				
<b>(program executed on external PC)<sup>b</sup></b>				
32-bit floating point	1	1	1	1
64-bit floating point	1	1	1	2
ASCII	5	15	26	96
<b>SCPI (program executed in the analyzer)<sup>d</sup></b>				
32-bit floating point	1	1	2	3
64-bit floating point	1	2	2	4
ASCII	8	29	56	222
<b>COM (program executed in the analyzer)<sup>e</sup></b>				
32-bit floating point	1	1	1	1
Variant type	1	1	2	6
<b>DCOM over 100 Mbit/s LAN</b>				
<b>(program executed on external PC)<sup>f</sup></b>				
32-bit floating point <sup>g</sup>	1	1	1	2
Variant type <sup>h</sup>	1	3	6	19

<sup>a</sup> Typical performance of unit with new 500 MHz Pentium III Processor.

<sup>b</sup> Measured using a VEE 5.0 program running on a 600 MHz HP Kayak, National Instruments™ GPIB card. Transferred complex S11 data, using "CALC:DATA?SDATA".

<sup>c</sup> Measured using a VEE 5.0 program running on a 600 MHz HP Kayak. Transferred complex S11 data, using "CALC:DATA?SDATA". Speed dependent on LAN traffic, if connected to network.

<sup>d</sup> Measured using a VEE 5.0 program running inside PNA Series Analyzer. Transferred complex S11 data, using "CALC:DATA?SDATA".

<sup>e</sup> Measured using a Visual Basic 6.0 program running inside PNA Series Analyzer. Transferred complex S11 data.

<sup>f</sup> Measured using a Visual Basic 6.0 program running on a 600 MHz HP Kayak. Transferred complex S11 data. Speed dependent on LAN traffic, if connected to network.

<sup>g</sup> Used IArray Transfer.getComplex method for 32-bit floating point.

<sup>h</sup> Used meas.getData method for Variant data type.

**Table 30. Recall and Sweep Speed<sup>a</sup>**

Operations	Number of Window(s)	Number of Trace(s)	Recall Time (ms)
Recall	1	1	49
Recall and Sweep	1	1	59
Recall	1	2	82
Recall and Sweep	1	2	96
Recall	1	4	159
Recall and Sweep	1	4	203
Recall	2	2	93
Recall and Sweep	2	2	115
Recall	3	4	158
Recall and Sweep	3	4	218
Recall	4	4	187
Recall and Sweep	4	4	247
Recall	4	8	340
Recall and Sweep	4	8	507

<sup>a</sup> CF= 177 MHz, Span = 200 MHz, 201 points, 35 kHz IF BW

## Specifications: Front-Panel Jumpers

### E8356A, 57A, 58A, Standard - Port 1

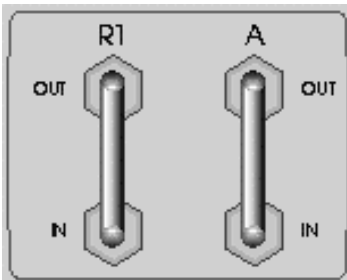

Use these SMA (female) connectors to develop custom measurements.

#### Receiver A Direct-Access Jumper

- The upper "A" connector comes from the coupled arm of the Port 1 coupler.
- The lower connector goes directly to the input of receiver "A." If Option 015 is installed, the path goes directly to a switchable attenuator and then to the receiver input.

Want to upgrade your analyzer? See information on [Front-Panel Jumpers with Option 015](#).

#### For the A Receiver Input:

Maximum Input Level:

- 6 dBm; <0.4 dB Compression (300 kHz to 3 GHz)
- 6 dBm; <0.8 dB Compression (3 GHz to 6 GHz)
- 11 dBm; <0.8 dB Compression (6 GHz to 9 GHz)

Noise Floor; rms (10 Hz Bandwidth):

- <-130 dBm (300 kHz to 25 MHz)
- <-123 dBm (3 GHz to 6 GHz)
- <-123 dBm (6 GHz to 9 GHz)

Damage Level: +15 dBm

Maximum DC Level: +/-5 V

Return Loss:

- >17 dB (300 kHz to 3 GHz)
- >12 dB (3 GHz to 6 GHz)
- >7 dB (6 GHz to 9 GHz)

#### **Reference Channel R1 Jumper**

- The upper connector comes from the transfer switch Reference 1 output.
- The lower connector goes directly to the R1 receiver input.

#### **For the R1 Receiver Input:**

Maximum Input Level:

- 6 dBm; <0.4 dB Compression (300 kHz to 3 GHz)
- 6 dBm; <0.8 dB Compression (3 GHz to 6 GHz)
- 11 dBm; <0.8 dB Compression (6 GHz to 9 GHz)

Damage Level: >+15 dBm

Minimum Level to Maintain Phase-Lock:

- 35 dBm (300 kHz to 3 GHz)
- 25 dBm (3 GHz to 9 GHz)

#### **For the Reference Output: (with an External Input to Lock the Source)**

##### **Output Level:**

- 5 to -30 dBm (300 kHz to 6 GHz)
- 10 to -35 dBm (6 GHz to 9 GHz)

Source Match Return Loss:

- 16 dB (300 kHz to 3 GHz)
- 14 dB (3 GHz to 9 GHz)

Damage Level: >+15 dBm

Maximum DC Level: 40V



## E8356A, 57A, 58A, Standard - Port 2

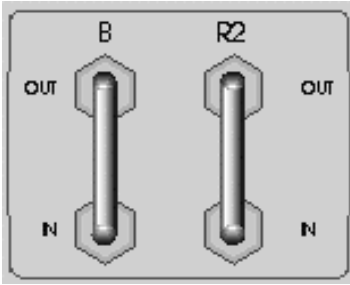

Use these SMA (female) connectors to develop custom measurements.

### Receiver B Direct-Access Jumper

- The upper "B" connector comes from the coupled arm of the Port 2 coupler.
- The lower connector goes directly to the input of receiver "B." If Option 015 is installed, the path goes directly to a switchable attenuator and then to the receiver input.

Want to upgrade your analyzer? See information on [Front-Panel Jumpers with Option 015](#).

### For the B Receiver Input:

Maximum Input Level:

- 6 dBm; <0.4 dB Compression (300 kHz to 3 GHz)
- 6 dBm; <0.8 dB Compression (3 GHz to 6 GHz)
- 11 dBm; <0.8 dB Compression (6 GHz to 9 GHz)

Noise Floor; rms (10 Hz Bandwidth):

- <-130 dBm (300 kHz to 25 MHz)
- <-123 dBm (3 GHz to 6 GHz)
- <-123 dBm (6 GHz to 9 GHz)

Damage Level: +15 dBm

Maximum DC Level: +/-5 V

Return Loss:

- >17 dB (300 kHz to 3 GHz)
- >12 dB (3 GHz to 6 GHz)
- >7 dB (6 GHz to 9 GHz)

### Reference Channel R2 Jumper

- The upper connector comes from the transfer switch Reference 2 output.
- The lower connector goes directly to the R2 receiver input.

### For the R2 Receiver Input:

Maximum Input Level:

- 6 dBm; <0.4 dB Compression (300 kHz to 3 GHz)
- 6 dBm; <0.8 dB Compression (3 GHz to 6 GHz)
- 11 dBm; <0.8 dB Compression (6 GHz to 9 GHz)

Damage Level: >+15 dBm

Minimum Level to Maintain Phase-Lock:

- 35 dBm (300 kHz to 3 GHz)
- 25 dBm (3 GHz to 9 GHz)

### For the Reference Output: (with an External Input to Lock the Source)

Output Level:

- 5 to -30 dBm (300 kHz to 6 GHz)
- 10 to -35 dBm (6 GHz to 9 GHz)

Source Match Return Loss:

16 dB (300 kHz to 3 GHz)

14 dB (3 GHz to 9 GHz)

Damage Level: >+15 dBm

Maximum DC Level: 40V

### **E8356A, 57A, 58A, Option 015 - Port 1**

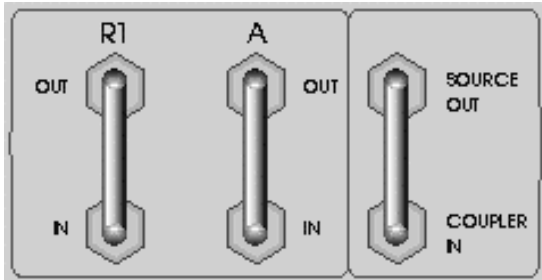

Use these SMA (female) connectors to develop custom measurements.

#### **Receiver A Direct-Access Jumper**

- The upper "A" connector comes from the coupled arm of the Port 1 coupler.
- The lower connector goes directly to the input of receiver "A." With Option 015, the path goes directly to a switchable attenuator and then to the receiver input.

#### **For the A Receiver Input:**

Maximum Input Level:

-6 dBm; <0.4 dB Compression (300 kHz to 3 GHz)

-6 dBm; <0.8 dB Compression (3 GHz to 6 GHz)

-11 dBm; <0.8 dB Compression (6 GHz to 9 GHz)

Noise Floor; rms (10 Hz Bandwidth):

<-130 dBm (300 kHz to 25 MHz)

<-123 dBm (3 GHz to 6 GHz)

<-123 dBm (6 GHz to 9 GHz)

Damage Level: +15 dBm

Maximum DC Level: +/-5 V

Return Loss:

>17 dB (300 kHz to 3 GHz)

>12 dB (3 GHz to 6 GHz)

>7 dB (6 GHz to 9 GHz)

#### **Reference Channel R1 Jumper**

- The upper connector comes from the transfer switch Reference 1 output.
- The lower connector goes directly to the R1 receiver input.

#### **For the R1 Receiver Input:**

Maximum Input Level:

-6 dBm; <0.4 dB Compression (300 kHz to 3 GHz)

-6 dBm; <0.8 dB Compression (3 GHz to 6 GHz)

-11 dBm; <0.8 dB Compression (6 GHz to 9 GHz)

Damage Level: >+15 dBm

Minimum Level to Maintain Phase-Lock:

-35 dBm (300 kHz to 3 GHz)

-25 dBm (3 GHz to 9 GHz)

### For the Reference Output: (with an External Input to Lock the Source)

Output Level:

- 5 to -30 dBm (300 kHz to 6 GHz)
- 10 to -35 dBm (6 GHz to 9 GHz)

Source Match Return Loss:

- 16 dB (300 kHz to 3 GHz)
- 14 dB (3 GHz to 9 GHz)

Damage Level: >+15 dBm

Maximum DC Level: 40V

#### Port 1 Test-Port Jumper

- The upper "source out" connector comes from the transfer switch Port 1 output.
- The lower "coupler in" connector goes directly to the main input of Port 1 coupler. This is where a power amplifier can be inserted to boost the test port power.

### For the Source Output:

Output Level:

- +12 to -83 dBm (300 kHz to 6 GHz)
- +7 to -88 dBm (6 GHz to 9 GHz)

Source Match: 15 dB at 9 GHz

### For the Input to the Coupler:

Insertion Loss to Test Port 1:

- <3.5 dB at 3 GHz
- <5 dB at 9 GHz

Maximum Input Power: 2 Watts, CW

Damage Level: 4 Watts, CW

---

### E8356A, 57A, 58A, Option 015 - Port 2

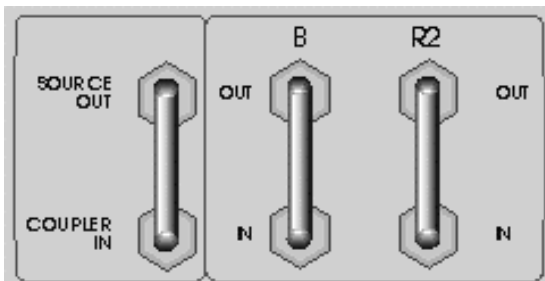

Use these SMA (female) connectors to develop custom measurements.

#### Receiver B Direct-Access Jumper

- The upper "B" connector comes from the coupled arm of the Port 2 coupler.
- The lower connector goes directly to the input of receiver "B." With Option 015, the path goes directly to a switchable attenuator and then to the receiver input.

### For the B Receiver Input:

Maximum Input Level:

- 6 dBm; <0.4 dB Compression (300 kHz to 3 GHz)
- 6 dBm; <0.8 dB Compression (3 GHz to 6 GHz)
- 11 dBm; <0.8 dB Compression (6 GHz to 9 GHz)

Noise Floor; rms (10 Hz Bandwidth):

- <-130 dBm (300 kHz to 25 MHz)
- <-123 dBm (3 GHz to 6 GHz)
- <-123 dBm (6 GHz to 9 GHz)

Damage Level: +15 dBm

Maximum DC Level: +/-5 V

Return Loss:

- >17 dB (300 kHz to 3 GHz)
- >12 dB (3 GHz to 6 GHz)
- >7 dB (6 GHz to 9 GHz)

#### Reference Channel R2 Jumper

- The upper connector comes from the transfer switch Reference 2 output.
- The lower connector goes directly to the R2 receiver input.

#### For the R2 Receiver Input:

Maximum Input Level:

- 6 dBm; <0.4 dB Compression (300 kHz to 3 GHz)
- 6 dBm; <0.8 dB Compression (3 GHz to 6 GHz)
- 11 dBm; <0.8 dB Compression (6 GHz to 9 GHz)

Damage Level: >+15 dBm

Minimum Level to Maintain Phase-Lock:

- 35 dBm (300 kHz to 3 GHz)
- 25 dBm (3 GHz to 9 GHz)

#### For the Reference Output: (with an External Input to Lock the Source)

Output Level:

- 5 to -30 dBm (300 kHz to 6 GHz)
- 10 to -35 dBm (6 GHz to 9 GHz)

Source Match Return Loss:

- 16 dB (300 kHz to 3 GHz)
- 14 dB (3 GHz to 9 GHz)

Damage Level: >+15 dBm

Maximum DC Level: 40V

#### Port 2 Test-Port Jumper

- The upper "source out" connector comes from the transfer switch Port 2 output.
- The lower "coupler in" connector goes directly to the main input of Port 2 coupler. This is where a power amplifier can be inserted to boost the test port power.

#### For the Source Output:

Output Level:

- +12 to -83 dBm (300 kHz to 6 GHz)
- +7 to -88 dBm (6 GHz to 9 GHz)

Source Match: 15 dB at 9 GHz

**For the Input to the Coupler:**

Insertion Loss to Test Port 2:

<3.5 dB at 3 GHz

<5 dB at 9 GHz

Maximum Input Power: 2 Watts, CW

Damage Level: 4 Watts, CW

**E8356A, E8357A, and E8358A Simplified Test Set Block Diagram**

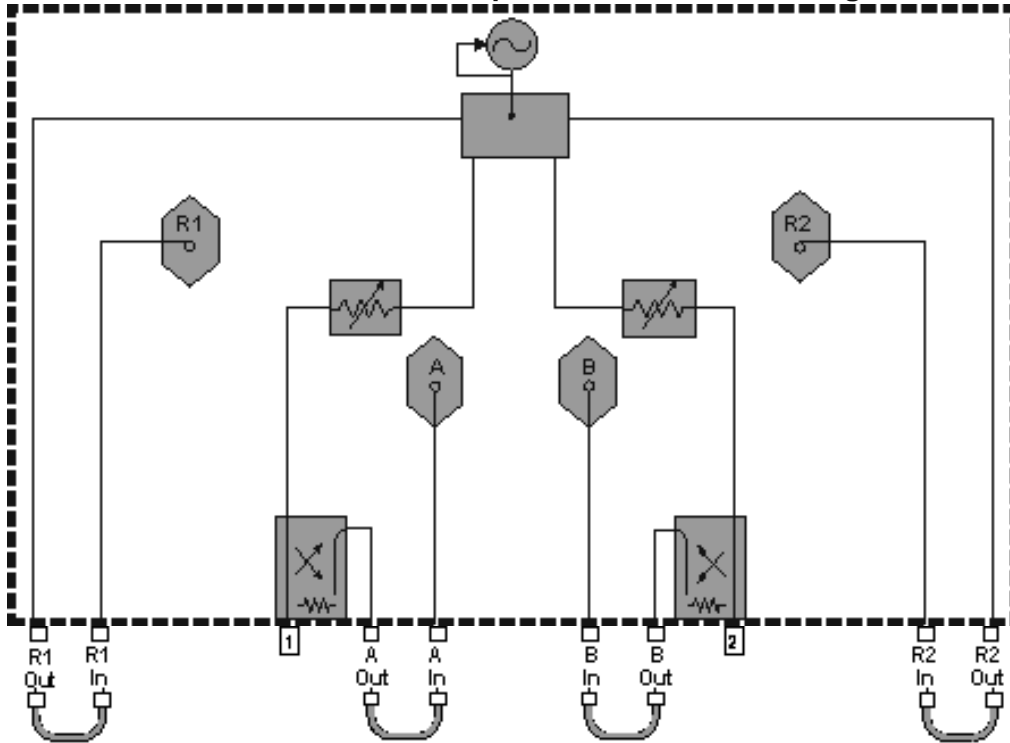

**E8356A, E8357A, and E8358A with Option 015 Simplified Test Set Block Diagram**

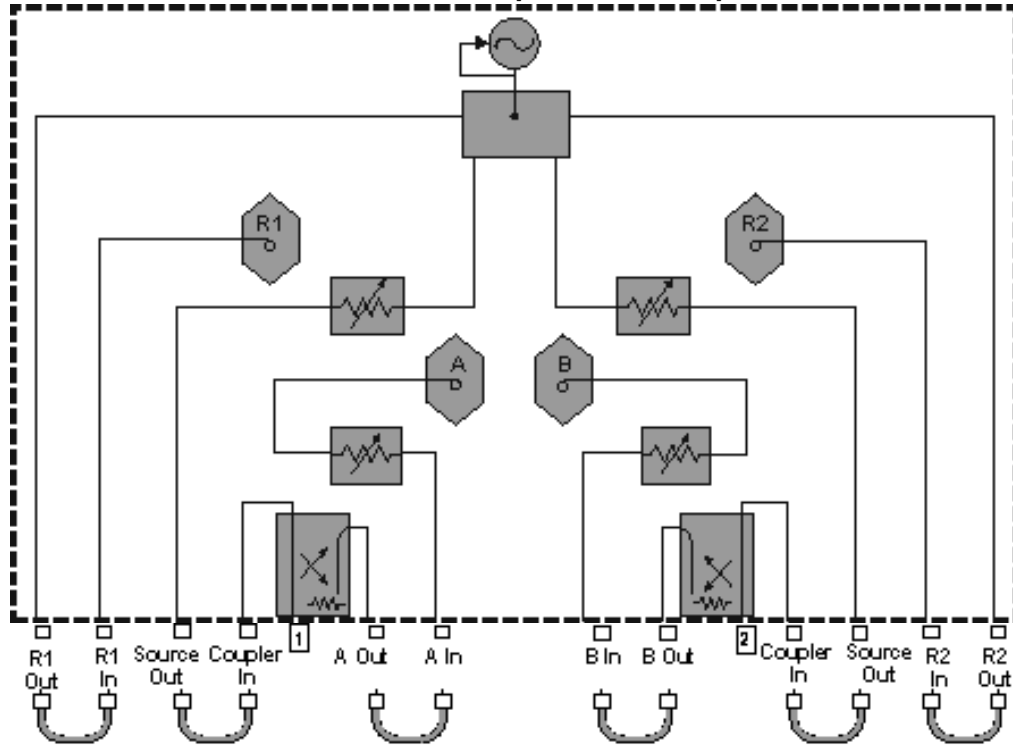

## 2. Technical Specifications for the E8801A, E8802A, E8803A

<b>Definitions</b> .....	2-3
<b>Corrected System Performance</b> .....	2-4
Table 1. System Dynamic Range .....	2-4
<b>Corrected System Performance with Type-N Connectors</b> .....	2-5
Table 2. Corrected System Performance With Type-N Device Connectors, 85032F Calibration Kit .....	2-5
Table 3. Corrected System Performance With Type-N Device Connectors, 85092C Electronic Calibration Module .....	2-6
<b>Corrected System Performance with 3.5 mm Connectors</b> .....	2-7
Table 4. Corrected System Performance With 3.5 mm Device Connector Type, 85033E Calibration Kit .....	2-7
Table 5. Corrected System Performance With 3.5 mm Device Connector Type, 85093C Electronic Calibration Module .....	2-8
Table 6. Corrected System Performance With 7-16 Device Connector Type, 85038A Calibration Kit .....	2-9
Table 7. Uncorrected Instrument Performance .....	2-10
<b>Test Port Output Characteristics (Source)</b> .....	2-10
Table 8. Test Port Output Frequency .....	2-10
Table 9. Test Port Output Power <sup>a</sup> .....	2-11
Table 10. Test Port Output Signal Purity .....	2-11
<b>Test Port and Receiver Input Characteristics</b> .....	2-12
Table 11. Test Port and Receiver Input Levels .....	2-12
Table 12. Test Port Input (Trace Noise) .....	2-13
Table 13. Test Port Input (Reference Level and Stability).....	2-13
Table 14. Test Port Input (Dynamic Accuracy specification <sup>a</sup> ) .....	2-13
Table 15. Test Port Input (Group Delay) <sup>a</sup> .....	2-15
<b>General Information</b> .....	2-15
Table 16. System Bandwidths .....	2-15
Table 17. Front Panel Information.....	2-16
Table 18. Rear Panel Information .....	2-17
Table 19. Rear Panel Information (continued).....	2-18
Table 20. Analyzer Environment and Dimensions .....	2-18
<b>Measurement Throughput Summary</b> .....	2-19
Table 21. Typical Cycle Time <sup>a,b</sup> (ms) .....	2-19
Table 22. Cycle Time vs. IF Bandwidth <sup>a</sup> .....	2-19
Table 23. Cycle Time vs. Number of Points <sup>a</sup> .....	2-20
Table 24. Data Transfer Time <sup>a</sup> (ms).....	2-21
Table 25. Recall and Sweep Speed <sup>a</sup> .....	2-22
<b>Specifications: Front-Panel Jumpers</b> .....	2-23
<b>Specifications: Front-Panel Jumpers, Port 1</b> .....	2-23
Receiver A Direct-Access Jumper .....	2-23
Reference Channel R Jumper.....	2-24
Port 1 Test-Port Jumper .....	2-24
<b>Specifications: Front-Panel Jumpers, Port 2</b> .....	2-25

<b>Receiver B Direct-Access Jumper .....</b>	<b>2-25</b>
<b>Port 2 Test-Port Jumper .....</b>	<b>2-25</b>
<b>E8801A, E8802A, and E8803A Simplified Test Set Block Diagram.....</b>	<b>2-26</b>
<b>E8801A, E8802A, and E8803A with Option 014 Simplified Test Set Block Diagram ...</b>	<b>2-26</b>



This is a complete list of the E8801A, E8802A, and E8803A network analyzer technical specifications.

- To optimize viewing of uncertainty curves, click the Maximize button.
- To view or print the PNA Series Data Sheet (a condensed version of the specifications), visit our web site at <http://www.agilent.com/find/pna>, select your analyzer model, and click on the link for the data sheet.
- The uncertainty curves contained in this document apply only to the setup conditions listed. Please download our free Uncertainty Calculator from [http://www.agilent.com/find/na\\_calculator](http://www.agilent.com/find/na_calculator) to generate the curves for your PNA setup. View the [equations](#) used to generate the uncertainty curves.

## Definitions

All specifications and characteristics apply over a 25 °C  $\pm$ 5 °C range (unless otherwise stated) and 90 minutes after the instrument has been turned on.

**Specification (spec.):** Warranted performance. Specifications include guardbands to account for the expected statistical performance distribution, measurement uncertainties, and changes in performance due to environmental conditions.

**Characteristic (char.):** A performance parameter that the product is expected to meet before it leaves the factory, but that is not verified in the field and is not covered by the product warranty. A characteristic includes the same guardbands as a specification.

**Typical (typ.):** Expected performance of an average unit which does not include guardbands. It is not covered by the product warranty.

**Nominal (nom.):** A general, descriptive term that does not imply a level of performance. It is not covered by the product warranty.

**Calibration:** The process of measuring known standards to characterize a network analyzer's systematic (repeatable) errors.

**Corrected (residual):** Indicates performance after error correction (calibration). It is determined by the quality of calibration standards and how well "known" they are, plus system repeatability, stability, and noise.

**Uncorrected (raw):** Indicates instrument performance without error correction. The uncorrected performance affects the stability of a calibration.

**Standard:** When referring to the analyzer, this includes no options unless noted otherwise.

## Corrected System Performance

The specifications in this section apply for measurements made with the E8801A, E8802A, and E8803A analyzer with the following conditions:

- 10 Hz IF bandwidth
- No averaging applied to data
- Environmental temperature of 25 °C  $\pm$ 5 °C, with < 1 °C deviation from calibration temperature
- Isolation calibration not omitted

---

**Note:** The uncertainty curves contained in these specifications apply only to the setup conditions listed. Please download our free Uncertainty Calculator from [http://www.agilent.com/find/na\\_calculator](http://www.agilent.com/find/na_calculator) to generate the curves for your PNA setup. View the equations used to generate the uncertainty curves.

---

**Table 1. System Dynamic Range**

Description	Specification (dB)	Characteristic (dB)
<b>Dynamic range<sup>a</sup> (at test port)</b>		
300 kHz to 25 MHz <sup>b</sup>	125	
25 MHz to 3 GHz <sup>b</sup>	128	
3 GHz to 6 GHz	118	
6 GHz to 9 GHz	115	
<b>Dynamic range<sup>c</sup> (at receiver input)</b>		
300 kHz to 25 MHz <sup>d</sup>		140
25 MHz to 3 GHz <sup>d</sup>		143
3 GHz to 6 GHz		133
6 GHz to 9 GHz		130

<sup>a</sup> The test port dynamic range is calculated as the difference between the test port rms noise floor and the source maximum output power. The effective dynamic range must take measurement uncertainties and interfering signals into account.

<sup>b</sup> May be limited to 100 dB at particular frequencies below 750 MHz due to spurious receiver residuals.

<sup>c</sup> The receiver input dynamic range is calculated as the difference between the receiver rms noise floor and the source maximum output power. The effective dynamic range must take measurement uncertainties and interfering signals into account. This set-up should only be used when the receiver input will never exceed its damage level. When the analyzer is in segment sweep mode, frequency segments can be defined with a higher power level when the extended dynamic range is required (i.e. the portion of the device's response with high insertion loss), and reduced power when receiver damage may occur (i.e. the portion of the device's response with low insertion loss).

<sup>d</sup> May be limited to 115 dB at particular frequencies below 750 MHz due to spurious receiver residuals.

# Corrected System Performance with Type-N Connectors

**Table 2. Corrected System Performance With Type-N Device Connectors, 85032F Calibration Kit**

Applies to the E8801A, E8802A, and E8803A analyzer, 85032F (Type-N, 50Ω) calibration kit, N6314A test port cable, and a full 2-port calibration. Also applies to the following conditions:

- IF bandwidth = 10 Hz
- No averaging applied to data
- Environmental temperature 25° ±5 °C, with < 1 °C deviation from calibration temperature
- Isolation calibration not omitted

Description	Specification (dB)			
	300 kHz to 1.3 GHz	1.3 GHz to 3 GHz	3 GHz to 6 GHz	6GHz to 9 GHz
Directivity	49	46	40	38
Source Match	41	40	36	35
Load Match	49	45	39	37
Reflection Tracking	±0.011	±0.021	±0.032	±0.054
Transmission Tracking	±0.012	±0.020	±0.055	±0.083

## Transmission Uncertainty (Specifications)

### Magnitude

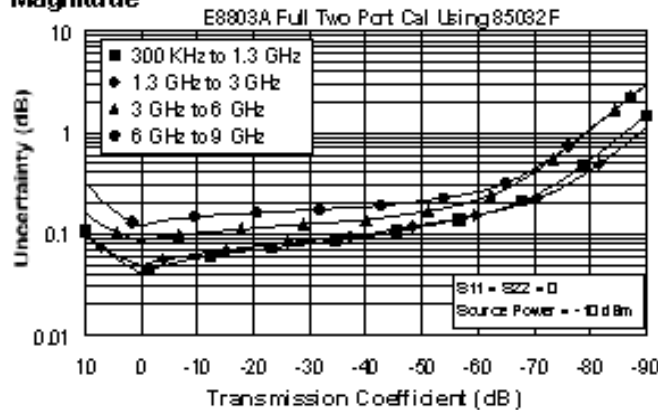

### Phase

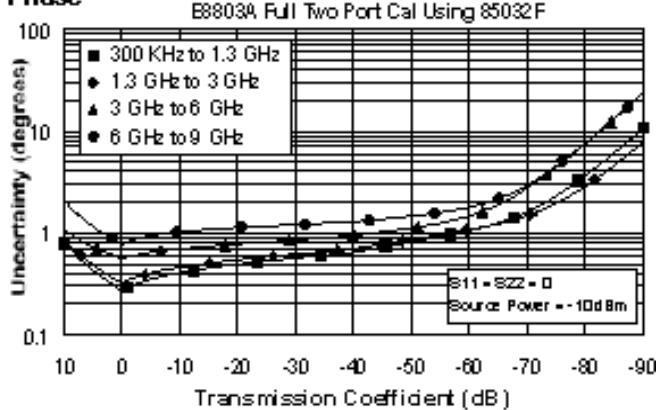

## Reflection Uncertainty (Specifications)

### Magnitude

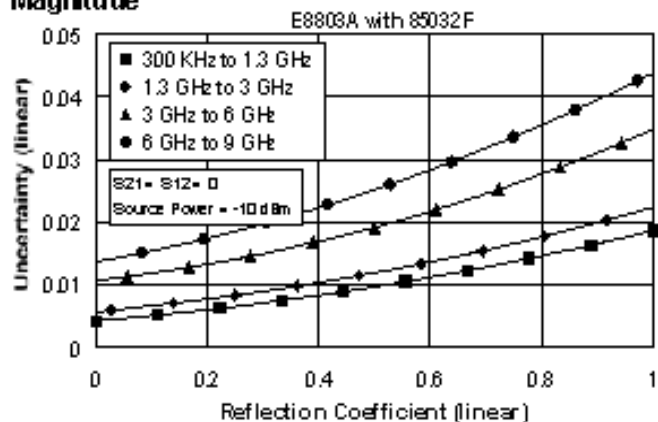

### Phase

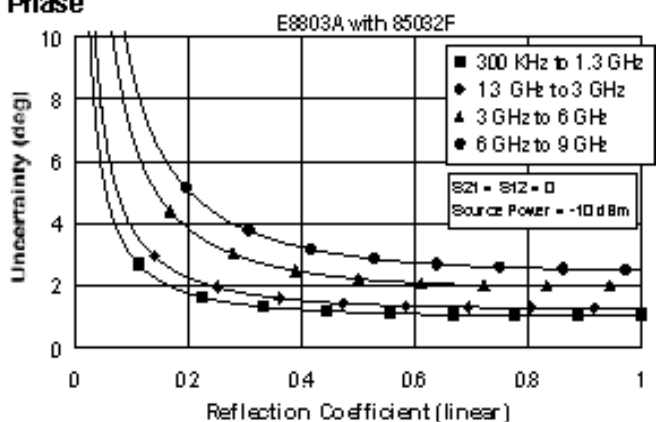

**Table 3. Corrected System Performance With Type-N Device Connectors, 85092C Electronic Calibration Module**

Applies to the E8801A, E8802A, and E8803A analyzer, 85092C (Type-N, 50Ω) electronic calibration (ECal) module, N6314A test port cable, and a full 2-port calibration. Also applies to the following conditions:

- IF bandwidth = 10 Hz
- No averaging applied to data
- Environmental temperature 25° ±5 °C, with < 1 °C deviation from calibration temperature
- Isolation calibration not omitted

Description	Specification (dB)			
	300 kHz to 1.3 GHz	1.3 GHz to 3 GHz	3 GHz to 6 GHz	6 to 9 GHz <sup>a</sup>
Directivity	52	54	52	47
Source Match	45	44	41	36
Load Match	47	47	44	39
Reflection Tracking	±0.040	±0.040	±0.060	±0.070
Transmission Tracking	±0.039	±0.039	±0.068	±0.136

**Transmission Uncertainty (Specifications)**

**Magnitude**

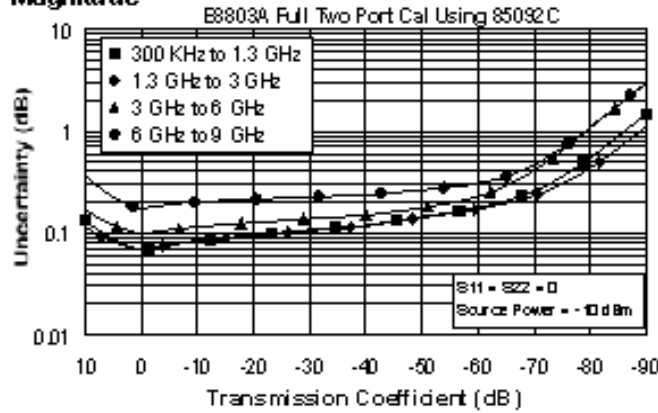

**Phase**

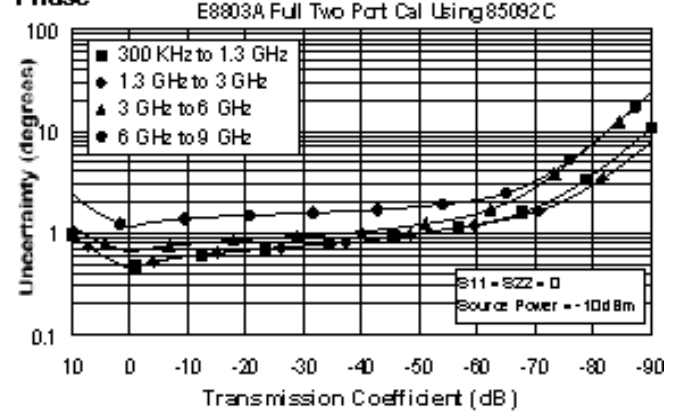

**Reflection Uncertainty (Specifications)**

**Magnitude**

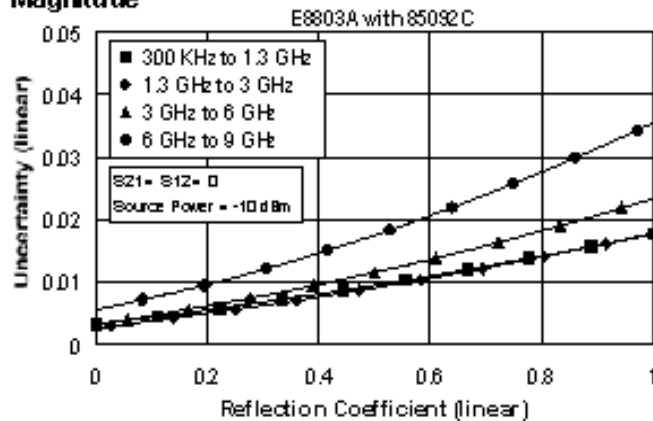

**Phase**

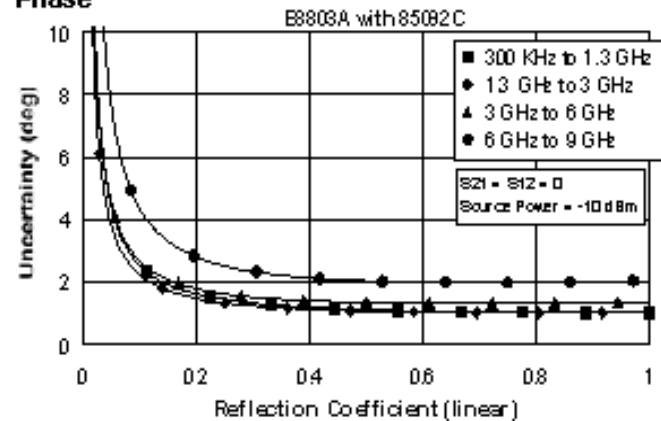

# Corrected System Performance with 3.5 mm Connectors

**Table 4. Corrected System Performance With 3.5 mm Device Connector Type, 85033E Calibration Kit**

Applies to the E8801A, E8802A, and E8803A analyzer, 85033E (3.5 mm, 50Ω) calibration kit, N6314A test port cable, and a full 2-port calibration. Also applies to the following conditions:

- IF bandwidth = 10 Hz
- No averaging applied to data
- Environmental temperature 25° ±5 °C, with < 1 °C deviation from calibration temperature
- Isolation calibration not omitted

Description	Specification (dB)			
	300 kHz to 1.3 GHz	1.3 GHz to 3 GHz	3 GHz to 6 GHz	6 GHz to 9 GHz
Directivity	46	44	38	38
Source Match	43	40	37	36
Load Match	46	44	38	38
Reflection Tracking	±0.006	±0.007	±0.009	±0.010
Transmission Tracking	±0.012	±0.021	±0.057	±0.075

## Transmission Uncertainty (Specifications)

### Magnitude

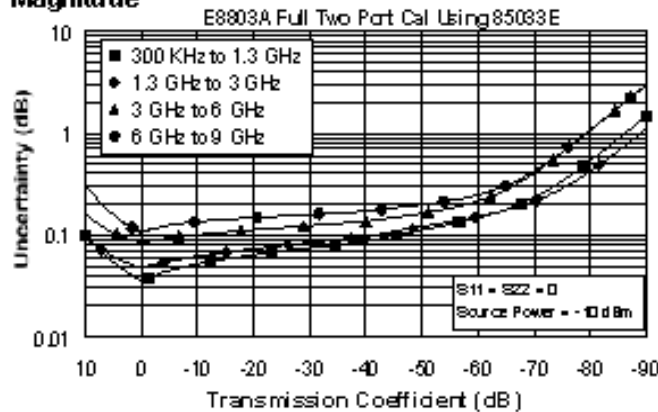

### Phase

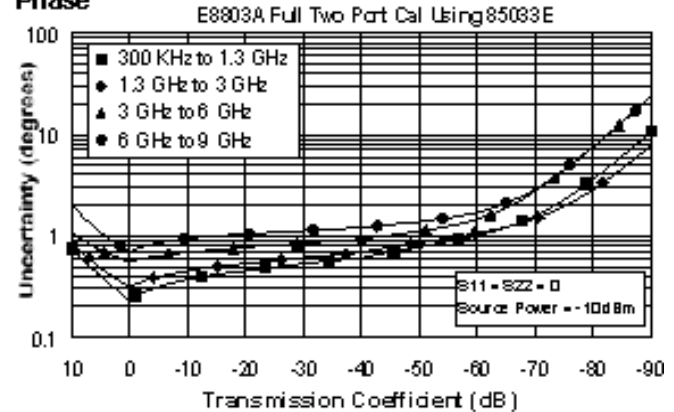

## Reflection Uncertainty (Specifications)

### Magnitude

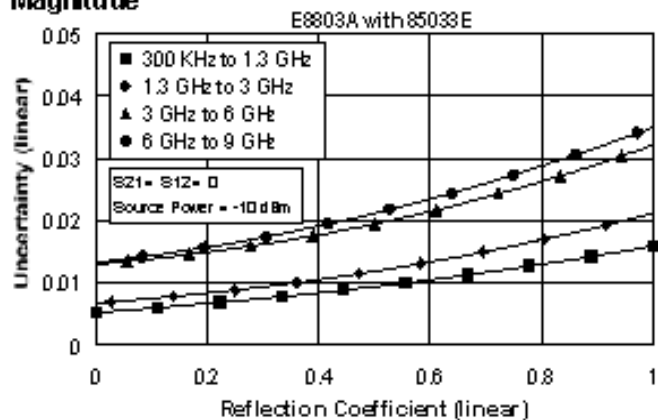

### Phase

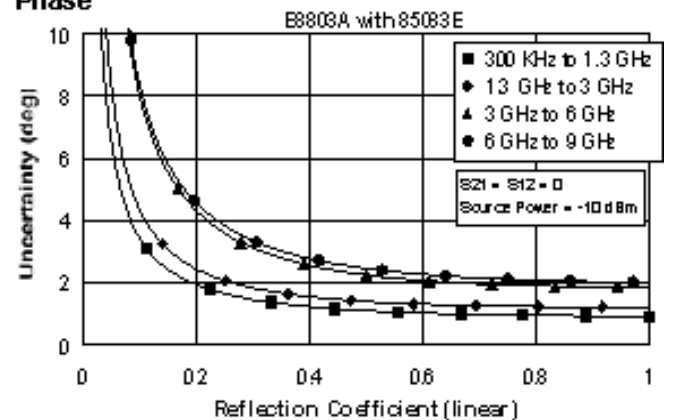

**Table 5. Corrected System Performance With 3.5 mm Device Connector Type, 85093C Electronic Calibration Module**

Applies to the E8801A, E8802A, and E8803A analyzer, 85093C (3.5 mm, 50Ω) electronic calibration (ECal) module, N6314A test port cable, and a full 2-port calibration. Also applies to the following conditions:

- IF bandwidth = 10 Hz
- No averaging applied to data
- Environmental temperature 25° ±5 °C, with < 1 °C deviation from calibration temperature
- Isolation calibration not omitted

Description	Specification (dB)			
	300 kHz to 1.3 GHz	1.3 GHz to 3 GHz	3 GHz to 6 GHz	6 GHz to 9 GHz <sup>a</sup>
Directivity	52	52	51	47
Source Match	44	44	39	34
Load Match	47	47	44	40
Reflection Tracking	±0.030	±0.040	±0.050	±0.070
Transmission Tracking	±0.039	±0.049	±0.068	±0.117

**Transmission Uncertainty (Specifications)**

**Magnitude**

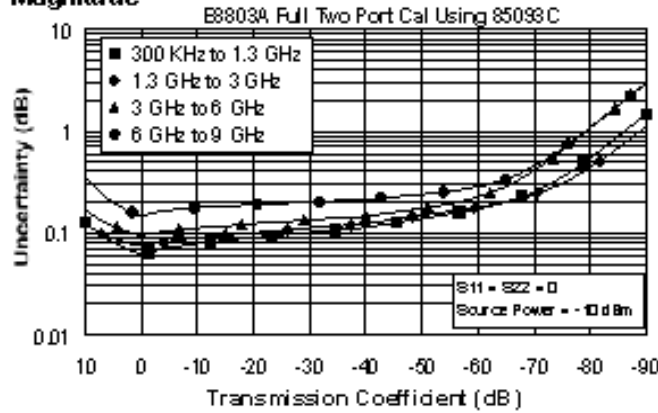

**Phase**

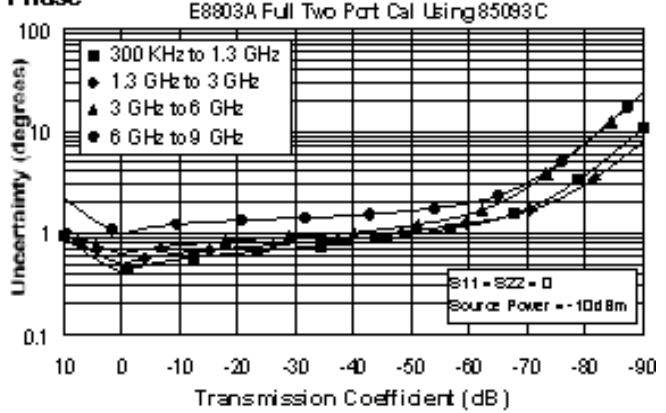

**Reflection Uncertainty (Specifications)**

**Magnitude**

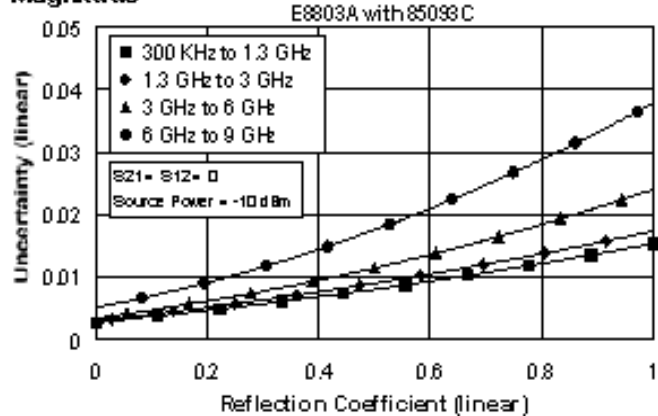

**Phase**

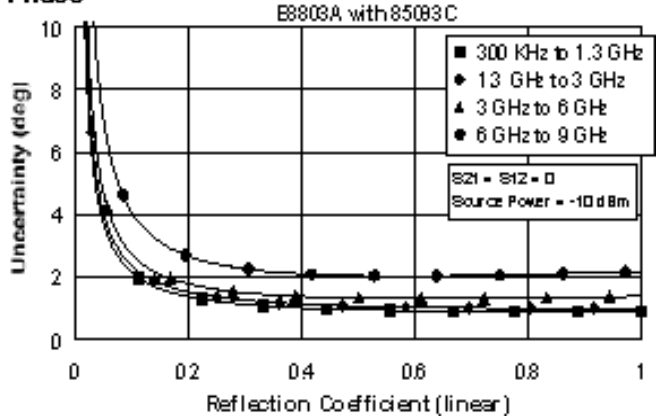

**Table 6. Corrected System Performance With 7-16 Device Connector Type, 85038A Calibration Kit**

Applies to the E8801A, E8802A, and E8803A analyzer, 85038A (7-16, 50Ω) calibration kit, N6314A test port cable, and a full 2-port calibration. Also applies to the following conditions:

- IF bandwidth = 10 Hz
- No averaging applied to data
- Environmental temperature 25° ±5 °C, with < 1 °C deviation from calibration temperature
- Isolation calibration not omitted

Description	Specification (dB)			
	300 kHz to 1.3 GHz	1.3 GHz to 3 GHz	3 to 6 GHz	6 to 9 GHz <sup>a</sup>
Directivity	40	40	36	36
Source Match	37	37	34	34
Load Match	39	39	35	35
Reflection Tracking	±0.089	±0.089	±0.115	±0.115
Transmission Tracking	±0.024	±0.033	±0.082	±0.103

**Transmission Uncertainty (Specifications)**

**Magnitude**

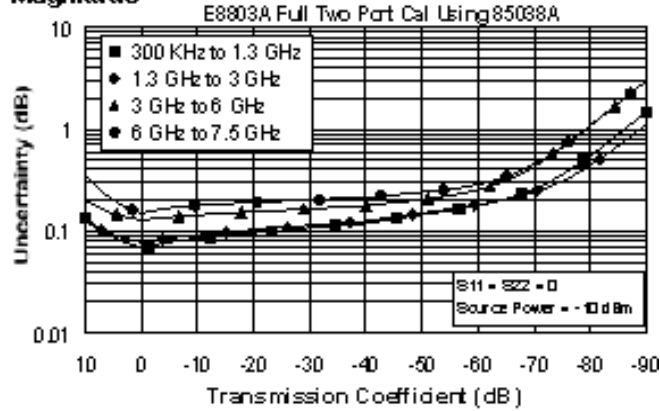

**Phase**

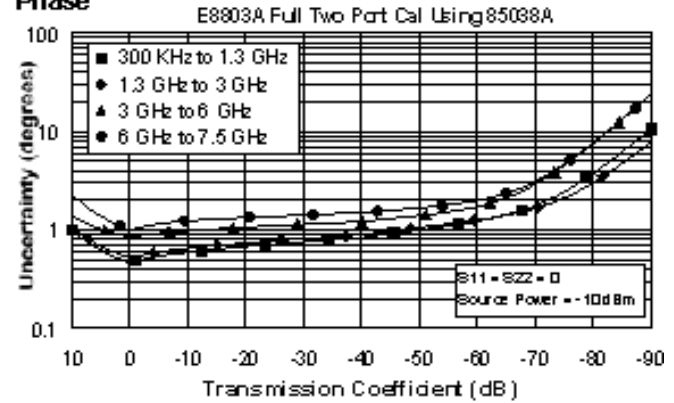

**Reflection Uncertainty (Specifications)**

**Magnitude**

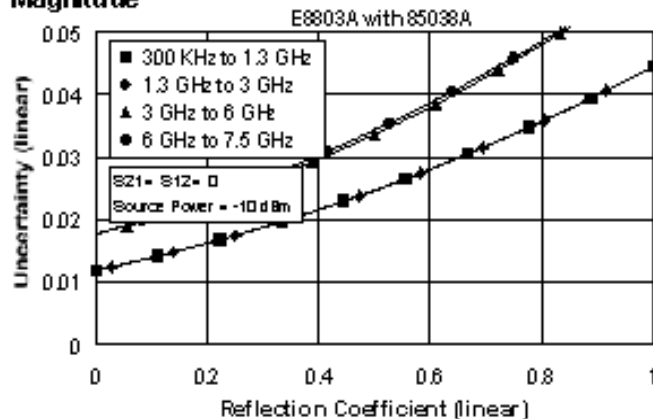

**Phase**

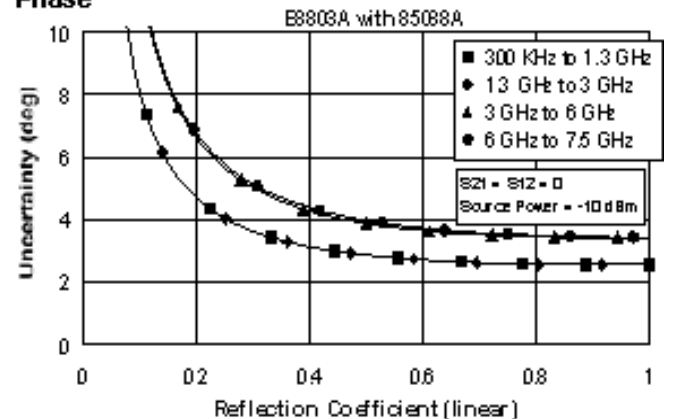

**Table 7. Uncorrected Instrument Performance**

Description	Specification (dB)				
	300 kHz to 1 MHz	1MHz to 1.3 GHz	1.3 GHz to 3 GHz	3 GHz to 6 GHz	6 GHz to 9 GHz
Directivity	30	33	27	20	13
Source Match	18	18	16	11	8
Load Match	20	20	17	13.5	13
Reflection Tracking	±1.5	±1.5	±1.5	±2.5	±3.0
Transmission Tracking	±1.5	±1.5	±1.5	±2.5	±3.0

## Test Port Output Characteristics (Source)

**Table 8. Test Port Output Frequency**

Description	Specification	Supplemental Information
<b>Range:</b>		
<b>E8801A</b>	300 kHz to 3.0 GHz	
<b>E8802A</b>	300 kHz to 6.0 GHz	
<b>E8803A</b>	300 kHz to 9.0 GHz	
<b>Resolution:</b>	1 Hz	
<b>Source Stability</b>		±1 ppm, 0°C to 40 °C, typical ±1ppm/year maximum
<b>Source Stability (Option 1E5)</b>		±0.05 ppm, 0° to 70 °C, typical ±0.1 ppm/year maximum
<b>CW Accuracy</b>	±3 ppm	
<b>CW Accuracy (Option 1E5)</b>	±1 ppm	



**Table 9. Test Port Output Power<sup>a</sup>**

Description	Specification	Supplemental Information
<b>Level Accuracy:</b>		
300 kHz to 6 GHz	±1.0 dB	Variation from 0 dBm in power range 0
6 GHz to 9 GHz	±2.0 dB	±1.5dB below 10 MHz
<b>Level Linearity:</b>		
		Variation from 0 dBm in power range 0
300 kHz to 9 GHz	±0.3 dB	-15 to +5 dBm
300 kHz to 1 MHz	±1.0 dB	+5 to +10 dBm
1 MHz to 6 GHz	±0.5 dB	+5 to +10 dBm
6 GHz to 9 GHz	±0.5 dB	+5 to +7 dBm
<b>Range<sup>b</sup>:</b>		
300 kHz to 6 GHz	-15 to +10 dBm	
6 GHz to 9 GHz	-15 to +7 dBm	
<b>Range<sup>b</sup>:</b>		
(Option 1E1):		
300 kHz to 6 GHz	-85 to +10 dBm	
6 GHz to 9 GHz	-85 to +7 dBm	
<b>Sweep Range</b>		
300 kHz to 6 GHz	25 dB	
6 GHz to 9 GHz	22 dB	
<b>Level Resolution</b>	0.01 dB	

<sup>a</sup> Source output performance on port 1 only. Port 2 output performance is typical.

<sup>b</sup> Power to which the source can be set and phase lock is assured.

**Table 10. Test Port Output Signal Purity**

Description	Specification	Supplemental Information
<b>Harmonics (2nd or 3rd)</b>		
at max output power (< 25 MHz)		< -25 dBc, typical
at max output power (25 MHz to 9 GHz)		< -25 dBc, characteristic <sup>a</sup>
at 0 dBm output		< -35 dBc, typical
at -10 dBm output		< -38 dBc, typical, in power range 0
<b>Non-harmonic Spurious</b>		
at max output		-30 dBc, typical for offset freq>1kHz
at -10 dBm output		-50 dBc, typical for offset freq >1kHz

<sup>a</sup> Typical below 25 MHz.

## Test Port and Receiver Input Characteristics

Table 11. Test Port and Receiver Input Levels

Description	Specification	Supplemental Information
<b>Maximum Test Port Input Level</b>		
Test Ports 1 and 2:		
300 kHz to 25 MHz	+10 dBm	< 0.6 dB compression
25 MHz to 3 GHz	+10 dBm	< 0.4 dB compression
3 GHz to 6 GHz	+10 dBm	< 0.7 dB compression
6 GHz to 9 GHz	+5 dBm	< 0.7 dB compression
<b>Damage Level</b>		
Test Port 1, 2		+30 dBm or $\pm 30$ VDC, typ.
R, A, B (Opt. 014)		+15 dBm or $\pm 5$ VDC, typ.
Coupler Thru (Opt. 014)		+33 dBm or $\pm 0$ VDC, typ.
<b>Test Port Noise Floor<sup>a</sup></b>		
300 kHz to 25 MHz <sup>b</sup>		
10 Hz IF Bandwidth	-115 dBm	
1 kHz IF Bandwidth	-95 dBm	
25 MHz to 3 GHz <sup>b</sup>		
10 Hz IF Bandwidth	-118 dBm	
1 kHz IF Bandwidth	-98 dBm	
3 GHz to 9 GHz		
10 Hz IF Bandwidth	$\leq -108$ dBm	
1 kHz IF Bandwidth	$\leq -88$ dBm	
<b>Receiver Noise Floor<sup>a</sup></b>		
300 kHz to 25 MHz <sup>c</sup>		
10 Hz IF Bandwidth	$\leq -130$ dBm	
1 kHz IF Bandwidth	$\leq -110$ dBm	
25 MHz to 3 GHz <sup>c</sup>		
10 Hz IF Bandwidth	$\leq -133$ dBm	
1 kHz IF Bandwidth	$\leq -113$ dBm	
6 GHz to 9 GHz		
10 Hz IF Bandwidth	$\leq -123$ dBm	
1 kHz IF Bandwidth	$\leq -103$ dBm	
<b>Crosstalk</b>		
		Between test ports 1 and 2, with short circuits at both ports
300 kHz to 1 MHz	$< -120$ dB	
1 MHz to 25 MHz	$< -125$ dB	
25 MHz to 3 GHz	$< -126$ dB	
3 GHz to 6 GHz	$< -117$ dB	
6 GHz to 9 GHz	$< -106$ dB	
<b>Maximum Receiver Input Level (A, B, R)</b>		
300 kHz to 6 GHz		-6 dBm, typical
6 GHz to 9 GHz		-9 dBm, typical
<b>Reference Input Level (R)<sup>d</sup></b>		
300 kHz to 9 GHz		-10 to -35 dBm, typical
<b>Maximum Coupler Input Level (Opt 014)</b>		
300 kHz to 9 GHz		+33 dBm, typical

<sup>a</sup> Total average (RMS) noise power calculated as the mean value of a linear magnitude trace expressed in dBm.

<sup>b</sup> May be limited to -90 dBm at particular frequencies below 750 MHz due to spurious receiver residuals.

<sup>c</sup> May be limited to -105 dBm at particular frequencies below 750 MHz due to spurious receiver residuals.

<sup>d</sup> Input level to maintain phase lock.

**Table 12. Test Port Input (Trace Noise)**

Description	Specification	Supplemental Information
<b>Trace Noise<sup>a</sup> Magnitude</b>		
1 kHz IF Bandwidth	< 0.002 dB rms	
10 kHz IF Bandwidth	< 0.005 dB rms	
<b>Trace Noise<sup>a</sup> Phase</b>		
1 kHz IF Bandwidth	< 0.010° rms	
10 kHz IF Bandwidth	< 0.035° rms	

<sup>a</sup> Trace noise is defined as a ratio measurement of a through or a full reflection, with the source set to 0 dBm.

**Table 13. Test Port Input (Reference Level and Stability)**

Description	Specification	Supplemental Information
<b>Reference Level Magnitude</b>		
Range	±200 dB	
Resolution	0.001 dB	
<b>Reference Level Phase</b>		
Range	±500°	
Resolution	0.01°	
<b>Stability Magnitude<sup>a</sup></b>		
300 kHz to 3 GHz		0.02 dB/°C, typical
3 GHz to 6 GHz		0.04 dB/°C, typical
6 GHz to 9 GHz		0.06 dB/°C, typical
<b>Stability Phase<sup>a</sup></b>		
300 kHz to 3 GHz		0.2°/°C, typical
3 GHz to 6 GHz		0.3°/°C, typical
6 GHz to 9 GHz		0.6°/°C, typical

<sup>a</sup> Stability is defined as a ratio measurement at the test port.

**Table 14. Test Port Input (Dynamic Accuracy specification<sup>a</sup>)**

Accuracy of the test port input power reading is relative to the reference input power level. Applies to input ports 1 and 2 with the following conditions:

- IF bandwidth = 10 Hz
- Environmental temperature 25° ±5 °C, with < 1 °C deviation from calibration temperature

300 kHz to 3 GHz

300 kHz to 3 GHz

**Magnitude**

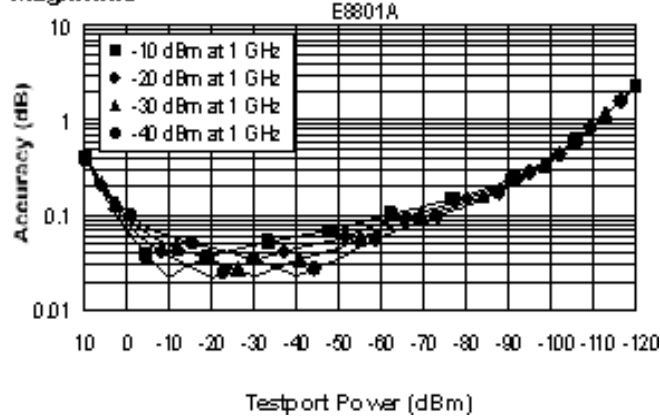

**Phase**

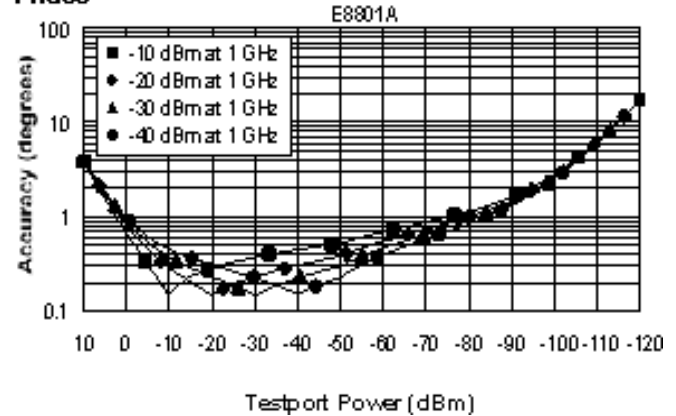

**Magnitude**

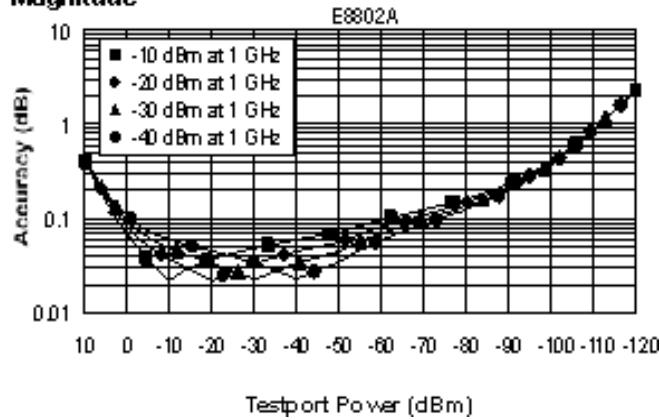

**Phase**

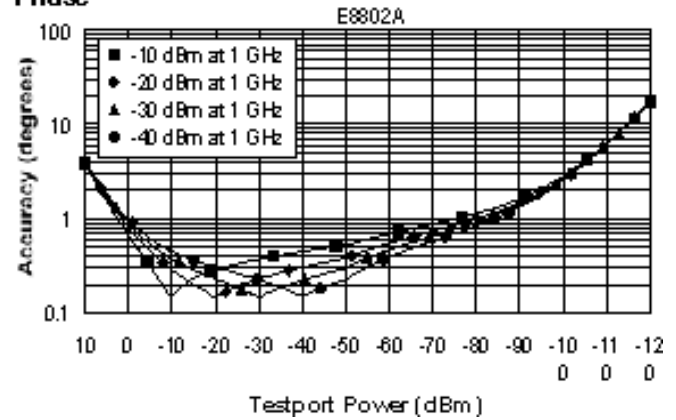

**Magnitude**

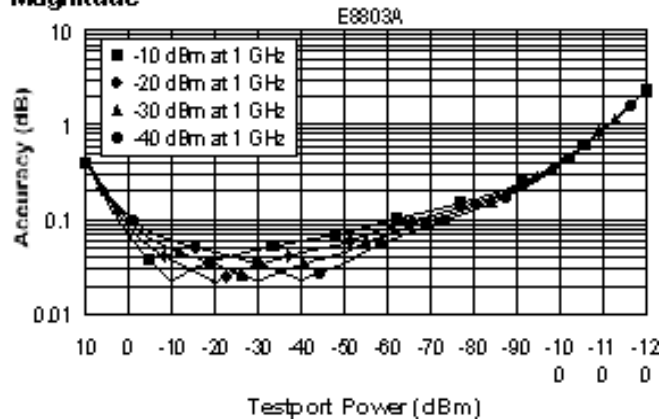

**Phase**

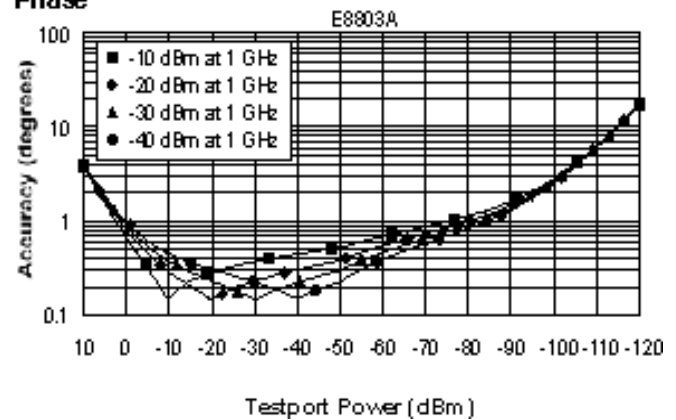

<sup>a</sup> Dynamic accuracy is verified with the following measurements:

- compression over frequency
- IF linearity at a single frequency of 1.195 GHz and a reference level of -20 dBm

**Table 15. Test Port Input (Group Delay)<sup>a</sup>**

Description	Specification	Supplemental Information
Aperture (selectable)	(frequency span)/(number of points -1)	
Maximum Aperture	20% of frequency span	
Range	0.5 x (1/minimum aperture)	
Maximum Delay		Limited to measuring no more than 180° of phase change within the minimum aperture.)
Accuracy		See graph below. Char.

The following graph shows group delay accuracy with type-N full 2-port calibration and a 10 Hz IF bandwidth. Insertion loss is assumed to be < 2 dB and electrical length to be ten meters.

**Group Delay (Typical)**

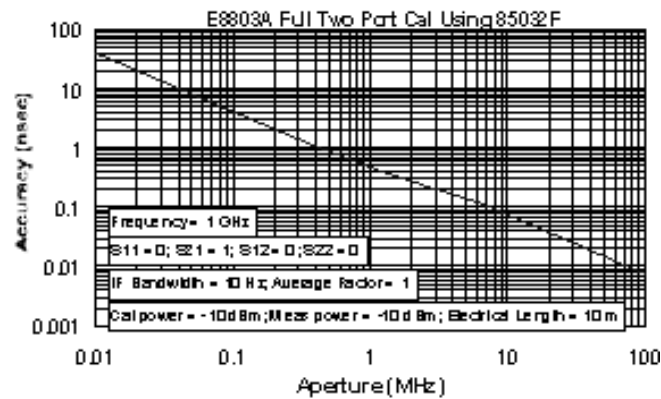

In general, the following formula can be used to determine the accuracy, in seconds, of specific group delay measurement:

$$\pm \text{Phase Accuracy (deg)} / [360 \times \text{Aperture (Hz)}]$$

Depending on the aperture and device length, the phase accuracy used is either incremental phase accuracy or worst case phase accuracy.

<sup>a</sup> Group delay is computed by measuring the phase change within a specified frequency step (determined by the frequency span and the number of points per sweep).

**General Information**

**Table 16. System Bandwidths**

Description	Specification	Supplemental Information
<b>IF Bandwidth Settings</b>		
Range		1 Hz to 40 kHz in a 1, 2, 3, 5, 7, 10 sequence up to 30 kHz, 35 kHz, 40kHz, nominal

**Table 17. Front Panel Information**

<b>Description</b>	<b>Supplemental Information</b>
<b>RF Connectors</b>	
Type	Type-N, female; 50 $\Omega$ , nominal
Center Pin Protrusion	0.204 to 0.207 in., characteristic
<b>Probe Power</b>	
Connector	3-pin connector, male
Positive Supply	+15 VDC $\pm$ 2%, 400 mA, max, characteristic
Negative Supply	-12.6 VDC $\pm$ 5%, 300 mA, max, characteristic
<b>Display</b>	
Size	21.3 cm (8.4 in) diagonal color active matrix LCD; 640 (horizontal) X 480 (vertical) resolution
Refresh Rate	Vertical 59.83 Hz; Horizontal 31.41 Hz
<b>Display Range</b>	
Magnitude	$\pm$ 200 dB (at 20 dB/div), max
Phase	$\pm$ 180°, max
Polar	10 pUnits, min 1000 Units, max
<b>Display Resolution</b>	
Magnitude	0.001 dB/div, min
Phase	0.01°/div, min
<b>Marker Resolution</b>	
Magnitude	0.001 dB, min
Phase	0.01°, min
Polar	0.01 mUnit, min; 0.01°,min

**Table 18. Rear Panel Information**

<b>Description</b>	<b>Supplemental Information</b>
<b>10 MHz Reference In</b>	
Connector	BNC, female
Input Frequency	10 MHz $\pm$ 1 ppm, typical
Input Level	-15 dBm to +20 dBm, typical
Input Impedance	200 $\Omega$ , nom.
<b>10 MHz Reference Out</b>	
Connector	BNC, female
Output Frequency	10 MHz $\pm$ 10 ppm, typical
Signal Type	Sine Wave, typical
Output Level	+10 dBm $\pm$ 4 dB into 50 $\Omega$ , typical
Output Impedance	50 $\Omega$ , nominal
Harmonics	<-40 dBc, typical
<b>VGA Video Output</b>	
Connector	15-pin mini D-Sub; Drives VGA compatible monitors
Devices Supported	Resolutions
Flat Panel (TFT)	1024 X 768, 800 X 600, 640 X 480
Flat Panel (DSTN)	800 X 600, 640 X 480
CRT Monitor	1280 X 1024, 1024 X 768, 800 X 600, 640 X 480
	Simultaneous operation of the internal and external displays is allowed, but with 640 X 480 resolution only. If you change resolution, you can only view the external display (internal display will "white out").
<b>Test Set IO</b>	25-pin D-Sub connector, available for external test set control
<b>Aux IO</b>	25-pin D-Sub connector, male, analog and digital IO
<b>Handler IO</b>	36-pin IDC D-ribbon socket connector; all input/output signals are default set to negative logic; can be reset to positive logic via GPIB command
<b>GPIB</b>	24-pin D-sub (Type D-24), female; compatible with IEEE-488.
<b>Parallel Port (LPT1)</b>	25-pin D-Sub connector, female; provides connection to printers or any other parallel port peripherals
<b>Serial Port (COM 1)</b>	9-pin D-Sub, male; compatible with RS-232
<b>USB Port</b>	
	Universal Serial Bus jack, Type A configuration (4 contacts inline, contact 1 on left); female
Contact 1	Vcc: 4.75 to 5.25 VDC, 500 mA, maximum
Contact 2	-Data
Contact 3	+Data
Contact 4	Ground
<b>LAN</b>	10/100BaseT Ethernet, 8-pin configuration; auto selects between the two data rates
<b>Line Power<sup>a, b</sup></b>	
Frequency at 110/115 V	50/60/400 Hz
Frequency at 230/240 V	50/60 Hz
Maximum Watts	350 W

<sup>a</sup> A third-wire ground is required.

<sup>b</sup> Power supply has a voltage autoswitching feature.

**Table 19. Rear Panel Information (continued)**

Description	Supplemental Information
<b>External AM Input</b>	
Description	Input provides low-frequency AM modulation to test port output signal, or shifts the test port output. Zero volts input gives the power level set by the instrument, a positive voltage gives a higher level, and a negative voltage gives a lower level.
Connector	BNC, female
Input Sensitivity	8 dB/V, typical
Bandwidth	1 kHz, typical
Input Impedance	1 k $\Omega$ , typical
<b>External Detector Input</b>	
Description	Input from an external, negative polarity diode detector provides ALC for a test port remote from instrument's front panel
Connector	BNC, female
Input Sensitivity	-500 mV yields approximately -3 dBm at detector's input, typical
Bandwidth	50 kHz, typical
Input Impedance	1 k $\Omega$ , nominal

**Table 20. Analyzer Environment and Dimensions**

Description	Supplemental Information		
<b>General Environmental</b>			
RFI/EMI Susceptibility	Defined by CISPR Pub. 11, Group 1, Class A, and IEC 50082-1		
ESD	Minimize using static-safe work procedures and an antistatic bench mat		
Dust	Minimize for optimum reliability		
<b>Operating Environment</b>			
Temperature	0 °C to +40 °C Instrument powers up, phase locks, and displays no error messages within this temperature range.		
Error-Corrected Temperature Range	25°C $\pm$ 5°C with less than 1°C deviation from calibration temp.		
Humidity	5% to 95% at +40 °C		
Altitude	0 to 4500 m (14,760 ft.)		
<b>Non-Operating Storage Environment</b>			
Temperature	-40 °C to +70 °C		
Humidity	0% to 90% at +65 °C (non-condensing)		
Altitude	0 to 15,240 m (50,000 ft.)		
<b>Cabinet Dimensions</b>			
	<b>Height</b>	<b>Width</b>	<b>Depth</b>
Excluding front and rear panel hardware and feet	222 mm 8.75 in	425 mm 16.75 in	426 mm 16.8 in
As shipped - includes front panel connectors, rear panel bumpers, and feet.	242 mm 9.5 in	425 mm 16.75 in	470 mm 18.5 in
As shipped plus handles	242 mm 9.5 in	458 mm 18 in	502 mm 19.75 in
As shipped plus rack-mount flanges	242 mm 9.5 in	483 mm 19 in	470 mm 18.5 in
As shipped plus handles and flanges	242 mm 9.5 in	483 mm 19 in	502 mm 19.75 in
<b>Weight</b>			
Net	24 kg (54 lb), nominal		
Shipping	32 kg (70 lb), nominal		



## Measurement Throughput Summary

Table 21. Typical Cycle Time<sup>a,b</sup> (ms)

	Number of Points			
	101	201	401	1601
<b>Start 1.8 GHz, Stop 2 GHz, 35 kHz IF bandwidth</b>				
Uncorrected, 1-port cal	7	10	16	52
2-Port cal	27	36	55	164
<b>Start 300 kHz, Stop 3 GHz, 35 kHz IF bandwidth</b>				
Uncorrected, 1-port cal	48	54	64	104
2-Port cal	103	119	145	254
<b>Start 300 kHz, Stop 9 GHz, 35 kHz IF bandwidth</b>				
Uncorrected, 1-port cal	51	57	64	103
2-Port cal	112	124	138	220

<sup>a</sup> Typical performance.

<sup>b</sup> Includes sweep time, retrace time and band-crossing time. Analyzer display turned off with DISPLAY:ENABLE OFF. Add 21 ms for display on. Data for one trace (S11) measurement..

Table 22. Cycle Time vs. IF Bandwidth<sup>a</sup>

Applies to the Preset condition (201 points, correction off) except for the following changes:

- CF = 1 GHz
- Span = 100 MHz
- Display off (add 21 ms for display on)

IF Bandwidth (Hz)	Cycle Time (ms) <sup>b</sup>
40,000	8
35,000	9
30,000	11
20,000	13
10,000	28
7000	36
5000	48
3000	72
1000	196
300	620
100	1875
30	8062
10	17877

<sup>a</sup> Typical performance.

<sup>b</sup> Cycle time includes sweep and retrace time.

**Table 23. Cycle Time vs. Number of Points<sup>a</sup>**

Applies to the Preset condition (35 kHz IF bandwidth, correction off) except for the following changes:

- CF = 1 GHz
- Span = 100 MHz
- Display off (add 21 ms for display on)

<b>Number of Points</b>	<b>Cycle Time (ms)<sup>b</sup></b>
3	4
11	4
51	5
101	6
201	9
401	16
801	29
1601	52

<sup>a</sup> Typical performance.

<sup>b</sup> Cycle time includes sweep and retrace time.

**Table 24. Data Transfer Time<sup>a</sup> (ms)**

	Number of Points			
	51	201	401	1601
<b>SCPI over GPIB</b>				
<b>(program executed on external PC)<sup>b</sup></b>				
32-bit floating point	3	7	12	43
64-bit floating point	4	12	22	84
ASCII	7	64	24	489
<b>SCPI over 100 Mbit/s LAN</b>				
<b>(program executed on external PC)<sup>b</sup></b>				
32-bit floating point	1	1	1	1
64-bit floating point	1	1	1	2
ASCII	5	15	26	96
<b>SCPI (program executed in the analyzer)<sup>d</sup></b>				
32-bit floating point	1	1	2	3
64-bit floating point	1	2	2	4
ASCII	8	29	56	222
<b>COM (program executed in the analyzer)<sup>e</sup></b>				
32-bit floating point	1	1	1	1
Variant type	1	1	2	6
<b>DCOM over 100 Mbit/s LAN</b>				
<b>(program executed on external PC)<sup>f</sup></b>				
32-bit floating point <sup>g</sup>	1	1	1	2
Variant type <sup>h</sup>	1	3	6	19

<sup>a</sup> Typical performance of unit with 500 MHz Pentium III processor.

<sup>b</sup> Measured using a VEE 5.0 program running on a 600 MHz HP Kayak, National Instruments™ GPIB card. Transferred complex S11 data, using "CALC:DATA?SDATA".

<sup>c</sup> Measured using a VEE 5.0 program running on a 600 MHz HP Kayak. Transferred complex S11 data, using "CALC:DATA?SDATA". Speed dependent on LAN traffic, if connected to network.

<sup>d</sup> Measured using a VEE 5.0 program running inside PNA Series Analyzer. Transferred complex S11 data, using "CALC:DATA?SDATA".

<sup>e</sup> Measured using a Visual Basic 6.0 program running inside PNA Series Analyzer. Transferred complex S11 data.

<sup>f</sup> Measured using a Visual Basic 6.0 program running on a 600 MHz HP Kayak. Transferred complex S11 data. Speed dependent on LAN traffic, if connected to network.

<sup>g</sup> Used IArray Transfer.getComplex method for 32-bit floating point.

<sup>h</sup> Used meas.getData method for Variant data type.

**Table 25. Recall and Sweep Speed<sup>a</sup>**

<b>Operations</b>	<b>Number of Window(s)</b>	<b>Number of Trace(s)</b>	<b>Recall Time (ms)</b>
Recall	1	1	49
Recall and Sweep	1	1	59
Recall	1	2	82
Recall and Sweep	1	2	96
Recall	1	4	159
Recall and Sweep	1	4	203
Recall	2	2	93
Recall and Sweep	2	2	115
Recall	3	4	158
Recall and Sweep	3	4	218
Recall	4	4	187
Recall and Sweep	4	4	247
Recall	4	8	340
Recall and Sweep	4	8	507

<sup>a</sup> CF=177 MHz, Span=200 MHz, 201 points, 35 kHz IF BW

## Specifications: Front-Panel Jumpers

Models E8801A, E8802A, E8803A Option 014

---

### Specifications: Front-Panel Jumpers, Port 1

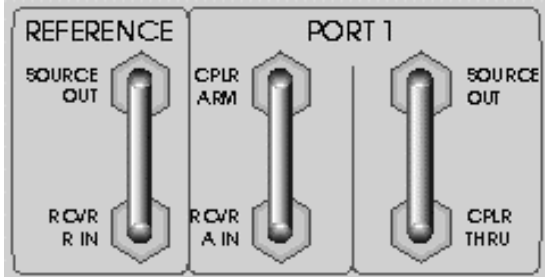

### Option 014 Analyzer

---

NOTE: The standard analyzer (E8801A/ E8802A/ E8803A) has no front-panel jumpers.

---

Use these SMA (female) connectors to develop custom measurements.

#### Receiver A Direct-Access Jumper

- The "Cplr Arm" connector comes from the coupled arm of the Port 1 coupler.
- The "Rcvr A In" connector goes directly to the input of receiver "A."

#### For the A Receiver Input:

Maximum Input Level:

- 6 dBm; <0.4 dB Compression (300 kHz to 3 GHz)
- 6 dBm; <0.8 dB Compression (3 GHz to 6 GHz)
- 11 dBm; <0.8 dB Compression (6 GHz to 9 GHz)

Noise Floor; rms (10 Hz Bandwidth):

- <-130 dBm (300 kHz to 25 MHz)
- <-123 dBm (3 GHz to 6 GHz)
- <-123 dBm (6 GHz to 9 GHz)

Damage Level: +15 dBm

Maximum DC Level: +/-5 V

Return Loss:

- >17 dB (300 kHz to 3 GHz)
- >12 dB (3 GHz to 6 GHz)
- >7 dB (6 GHz to 9 GHz)

### Reference Channel R Jumper

- The "Source Out" connector comes from the source Reference output.
- The "Rcvr R In" connector goes directly to the R receiver input.

### For the R Receiver Input:

Maximum Input Level:

- 6 dBm; <0.4 dB Compression (300 kHz to 3 GHz)
- 6 dBm; <0.8 dB Compression (3 GHz to 6 GHz)
- 11 dBm; <0.8 dB Compression (6 GHz to 9 GHz)

Damage Level: >+15 dBm

Minimum Level to Maintain Phase-Lock:

- 35 dBm (300 kHz to 3 GHz)
- 25 dBm (3 GHz to 9 GHz)

### For the Reference Output: (with an External Input to Lock the Source)

Output Level:

- 5 to -30 dBm (300 kHz to 6 GHz)
- 10 to -35 dBm (6 GHz to 9 GHz)

Source Match Return Loss:

- 16 dB (300 kHz to 3 GHz)
- 14 dB (3 GHz to 9 GHz)

Damage Level: >+15 dBm

Maximum DC Level: 40V

### Port 1 Test-Port Jumper

- The upper "Source Out" connector comes from the transfer switch Port 1 output.
- The lower "Coupler Thru" connector goes directly to the main input of Port 1 coupler. This is where a power amplifier can be inserted to boost the test port power.

### For the Source Output:

Output Level:

- +12 to -83 dBm (300 kHz to 6 GHz)
- +7 to -88 dBm (6 GHz to 9 GHz)

Source Match: 15 dB at 9 GHz

### For the Input to the Coupler:

Insertion Loss to Test Port 1:

- <3.5 dB at 3 GHz
- <5 dB at 9 GHz

Maximum Input Power: 2 Watts, CW

Damage Level: 4 Watts, CW

## Specifications: Front-Panel Jumpers, Port 2

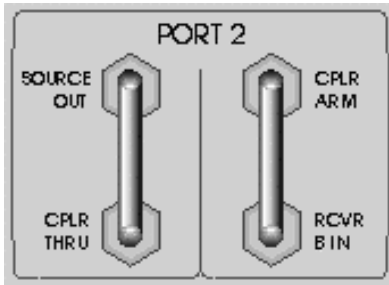

### Option 014 Analyzer

NOTE: The standard analyzer (E8801A/ E8802A/ E8803A) has no front-panel jumpers.

Use these SMA (female) connectors to develop custom measurements.

#### Receiver B Direct-Access Jumper

- The upper "Cplr Arm" connector comes from the coupled arm of the Port 2 coupler.
- The "Rcvr B In" connector goes directly to the input of receiver "B."

#### For the B Receiver Input:

Maximum Input Level:

- 6 dBm; <0.4 dB Compression (300 kHz to 3 GHz)
- 6 dBm; <0.8 dB Compression (3 GHz to 6 GHz)
- 11 dBm; <0.8 dB Compression (6 GHz to 9 GHz)

Noise Floor; rms (10 Hz Bandwidth):

- <-130 dBm (300 kHz to 25 MHz)
- <-123 dBm (3 GHz to 6 GHz)
- <-123 dBm (6 GHz to 9 GHz)

Damage Level: +15 dBm

Maximum DC Level: +/-5 V

Return Loss:

- >17 dB (300 kHz to 3 GHz)
- >12 dB (3 GHz to 6 GHz)
- >7 dB (6 GHz to 9 GHz)

#### Port 2 Test-Port Jumper

- The upper "Source Out" connector comes from the transfer switch Port 2 output.
- The lower "Coupler Thru" connector goes directly to the main input of Port 2 coupler. This is where a power amplifier can be inserted to boost the test port power.

#### For the Source Output:

Output Level:

- +12 to -83 dBm (300 kHz to 6 GHz)
- +7 to -88 dBm (6 GHz to 9 GHz)

Source Match: 15 dB at 9 GHz

#### For the Input to the Coupler:

Insertion Loss to Test Port 2:

- <3.5 dB at 3 GHz
- <5 dB at 9 GHz

Maximum Input Power: 2 Watts, CW

Damage Level: 4 Watts, CW

**E8801A, E8802A, and E8803A Simplified Test Set Block Diagram**

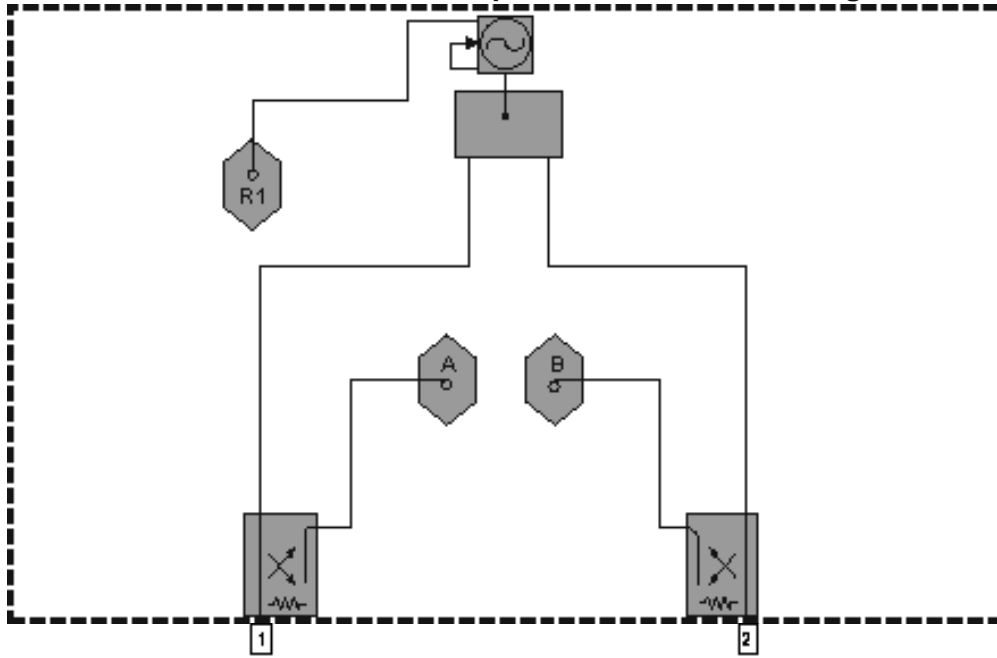

**E8801A, E8802A, and E8803A with Option 014 Simplified Test Set Block Diagram**

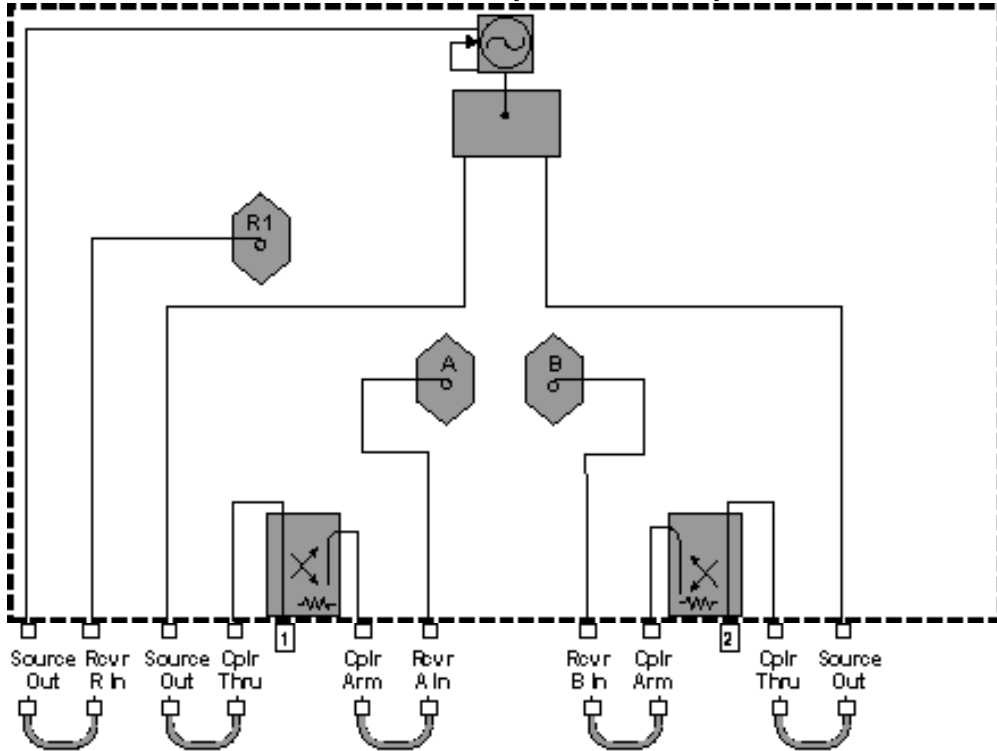



### 3 Technical Specifications for the N3381A, N3382A, N3383A

<b>Definitions</b> .....	3-3
<b>Corrected System Performance</b> .....	3-4
Table 1. System Dynamic Range .....	3-4
<b>Corrected System Performance with Type-N Connectors</b> .....	3-5
Table 2. Corrected System Performance With Type-N Device Connectors, 85032F Calibration Kit .....	3-5
Table 3. Corrected System Performance With Type-N Device Connectors, 85092C Electronic Calibration Module .....	3-6
<b>Corrected System Performance with 3.5 mm Connectors</b> .....	3-7
Table 4. Corrected System Performance With 3.5 mm Device Connector Type, 85033E Calibration Kit .....	3-7
Table 5. Corrected System Performance With 3.5 mm Device Connector Type, 85093C Electronic Calibration Module .....	3-8
Table 6. Corrected System Performance With 7-16 Device Connector Type, 85038A Calibration Kit .....	3-9
Table 7. Uncorrected Instrument Performance .....	3-10
<b>Test Port Output Characteristics (Source)</b> .....	3-10
Table 8. Test Port Output Frequency .....	3-10
Table 9. Test Port Output Power <sup>a</sup> .....	3-11
Table 10. Test Port Output Signal Purity .....	3-11
<b>Test Port and Receiver Input Characteristics</b> .....	3-12
Table 11. Test Port and Receiver Input Levels .....	3-12
Table 12. Test Port Input (Trace Noise) .....	3-13
Table 13. Test Port Input (Reference Level and Stability) .....	3-14
Table 14. Test Port Input (Dynamic Accuracy specification <sup>a</sup> ) .....	3-15
Table 15. Test Port Input (Group Delay) <sup>a</sup> .....	3-17
<b>General Information</b> .....	3-18
Table 16. System Bandwidths .....	3-18
Table 17. Front Panel Information .....	3-18
Table 18. Rear Panel Information .....	3-19
Table 19. Rear Panel Information (continued) .....	3-20
Table 20. Analyzer Environment and Dimensions .....	3-21
<b>Measurement Throughput Summary</b> .....	3-22
Table 21. Typical Cycle Time <sup>a,b</sup> (ms) .....	3-22
Table 22. Cycle Time vs. IF Bandwidth <sup>a</sup> .....	3-22
Table 23. Cycle Time vs. Number of Points <sup>a</sup> .....	3-23
Table 24. Data Transfer Time <sup>a</sup> (ms) .....	3-24
Table 25. Recall and Sweep Speed <sup>a</sup> .....	3-25
<b>Specifications: Front-Panel Jumpers</b> .....	3-26
<b>Specifications: Front-Panel Jumpers, Port 1</b> .....	3-26
Receiver A Direct-Access Jumper .....	3-26
Reference Channel R Jumper .....	3-26
Port 1 Test-Port Jumper .....	3-27
<b>Specifications: Front-Panel Jumpers, Port 2 and Port 3</b> .....	3-28
Receiver B Direct-Access Jumper .....	3-28

<b>Port 2 Test-Port Jumper .....</b>	<b>3-28</b>
<b>Receiver C Direct-Access Jumper .....</b>	<b>3-29</b>
<b>N3381A, N3382A, and N3383A Simplified Test Set Block Diagram .....</b>	<b>3-30</b>
<b>N3381A, N3382A, and N3383A with Option 014 Simplified Test Set Block Diagram...</b>	<b>3-30</b>

This is a complete list of the N3381A, N3382A, and N3383A network analyzer technical specifications.

- To optimize viewing of uncertainty curves, click the Maximize button.
- To view or print the PNA Series Data Sheet (a condensed version of the specifications), visit our web site at <http://www.agilent.com/find/pna>, select your analyzer model, and click on the link for the data sheet.
- The uncertainty curves contained in this document apply only to the setup conditions listed. Please download our free Uncertainty Calculator from [http://www.agilent.com/find/na\\_calculator](http://www.agilent.com/find/na_calculator) to generate the curves for your PNA setup. View the [equations](#) used to generate the uncertainty curves.

---

## Definitions

All specifications and characteristics apply over a 25 °C  $\pm$ 5 °C range (unless otherwise stated) and 90 minutes after the instrument has been turned on.

**Specification (spec.):** Warranted performance. Specifications include guardbands to account for the expected statistical performance distribution, measurement uncertainties, and changes in performance due to environmental conditions.

**Characteristic (char.):** A performance parameter that the product is expected to meet before it leaves the factory, but that is not verified in the field and is not covered by the product warranty. A characteristic includes the same guardbands as a specification.

**Typical (typ.):** Expected performance of an average unit which does not include guardbands. It is not covered by the product warranty.

**Nominal (nom.):** A general, descriptive term that does not imply a level of performance. It is not covered by the product warranty.

**Calibration:** The process of measuring known standards to characterize a network analyzer's systematic (repeatable) errors.

**Corrected (residual):** Indicates performance after error correction (calibration). It is determined by the quality of calibration standards and how well "known" they are, plus system repeatability, stability, and noise.

**Uncorrected (raw):** Indicates instrument performance without error correction. The uncorrected performance affects the stability of a calibration.

**Standard:** When referring to the analyzer, this includes no options unless noted otherwise.

## Corrected System Performance

The specifications in this section apply for measurements made with the N3381A, N3382A, and N3383A analyzer with the following conditions:

- 10 Hz IF bandwidth
- No averaging applied to data
- Environmental temperature of 25 °C  $\pm$ 5 °C, with < 1 °C deviation from calibration temperature
- Isolation calibration not omitted

---

**Note:** The uncertainty curves contained in these specifications apply only to the setup conditions listed. Please download our free Uncertainty Calculator from [http://www.agilent.com/find/na\\_calculator](http://www.agilent.com/find/na_calculator) to generate the curves for your PNA setup. View the equations used to generate the uncertainty curves.

---

**Table 1. System Dynamic Range**

Description	Specification (dB)	Characteristic (dB)
<b>Dynamic range<sup>a</sup> (at test port)</b>		
300 kHz to 25 MHz <sup>b</sup>	125	
25 MHz to 3 GHz <sup>b</sup>	128	
3 GHz to 6 GHz	118	
6 GHz to 9 GHz	115	
<b>Dynamic range<sup>c</sup> (at receiver input)</b>		
300 kHz to 25 MHz <sup>d</sup>		140
25 MHz to 3 GHz <sup>d</sup>		143
3 GHz to 6 GHz		133
6 GHz to 9 GHz		130

<sup>a</sup> The test port dynamic range is calculated as the difference between the test port rms noise floor and the source maximum output power. The effective dynamic range must take measurement uncertainties and interfering signals into account.

<sup>b</sup> May be limited to 100 dB at particular frequencies below 750 MHz due to spurious receiver residuals.

<sup>c</sup> The receiver input dynamic range is calculated as the difference between the receiver rms noise floor and the source maximum output power. The effective dynamic range must take measurement uncertainties and interfering signals into account. This set-up should only be used when the receiver input will never exceed its damage level. When the analyzer is in segment sweep mode, frequency segments can be defined with a higher power level when the extended dynamic range is required (i.e. the portion of the device's response with high insertion loss), and reduced power when receiver damage may occur (i.e. the portion of the device's response with low insertion loss). Specification applies only when power is sourced from Port 1. If power is sourced from either Port 2 or Port 3, dynamic range decreases by 3 dB.

<sup>d</sup> May be limited to 115 dB at particular frequencies below 750 MHz due to spurious receiver residuals.

## Corrected System Performance with Type-N Connectors

**Table 2. Corrected System Performance With Type-N Device Connectors, 85032F Calibration Kit**

Applies to the N3381A, N3382A, and N3383A analyzer, 85032F (Type-N, 50Ω) calibration kit, N6314A test port cable, and a full 2-port calibration. Also applies to the following conditions:

- IF bandwidth = 10 Hz
- No averaging applied to data
- Environmental temperature 25° ±5 °C, with < 1 °C deviation from calibration temperature
- Isolation calibration not omitted

Description	Specification (dB)			
	300 kHz to 1.3 GHz	1.3 GHz to 3 GHz	3 to 6 GHz	6 to 9 GHz
Directivity	49	46	40	38
Source Match	41	40	36	35
Load Match	49	45	39	37
Reflection Tracking	±0.011	±0.021	±0.032	±0.054
Transmission Tracking	±0.012	±0.020	±0.055	±0.083

### Transmission Uncertainty (Specifications)

#### Magnitude

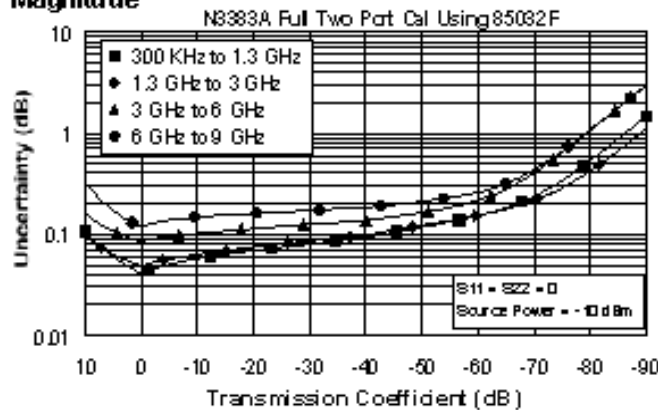

#### Phase

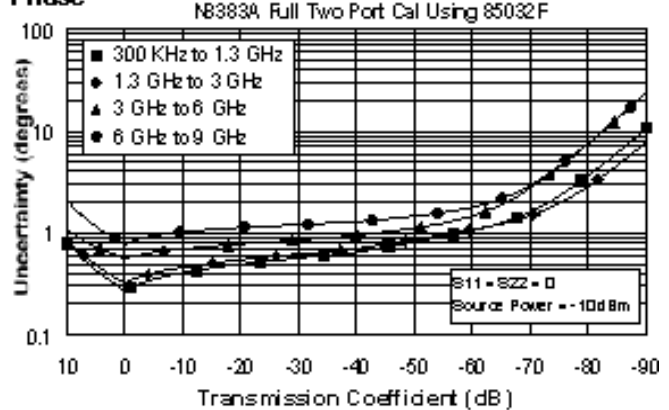

### Reflection Uncertainty (Specifications)

#### Magnitude

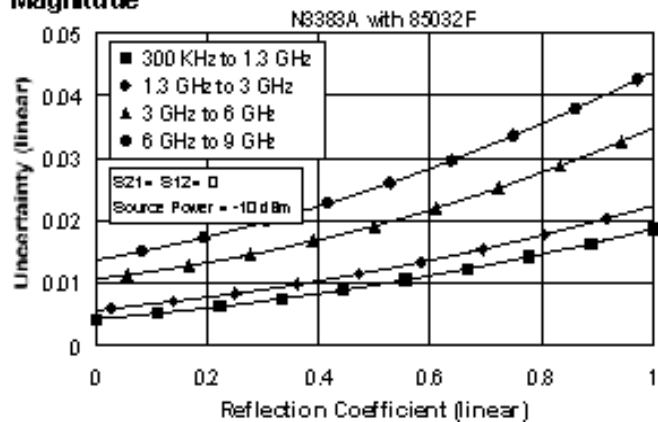

#### Phase

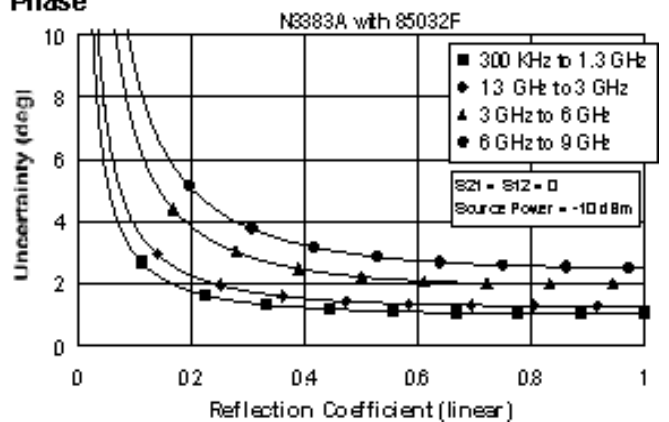

**Table 3. Corrected System Performance With Type-N Device Connectors, 85092C Electronic Calibration Module**

Applies to the N3381A, N3382A, and N3383A analyzer, 85092C (Type-N, 50Ω) electronic calibration (ECal) module, N6314A test port cable, and a full 2-port calibration. Also applies to the following conditions:

- IF bandwidth = 10 Hz
- No averaging applied to data
- Environmental temperature 25° ±5 °C, with < 1 °C deviation from calibration temperature
- Isolation calibration not omitted

Description	Specification (dB)			
	300 kHz to 1.3 GHz	1.3 GHz to 3 GHz	3 to 6 GHz	6 to 9 GHz <sup>a</sup>
Directivity	52	54	52	47
Source Match	45	44	41	36
Load Match	47	47	44	39
Reflection Tracking	±0.040	±0.040	±0.060	±0.070
Transmission Tracking	±0.039	±0.039	±0.068	±0.136

**Transmission Uncertainty (Specifications)**

**Magnitude**

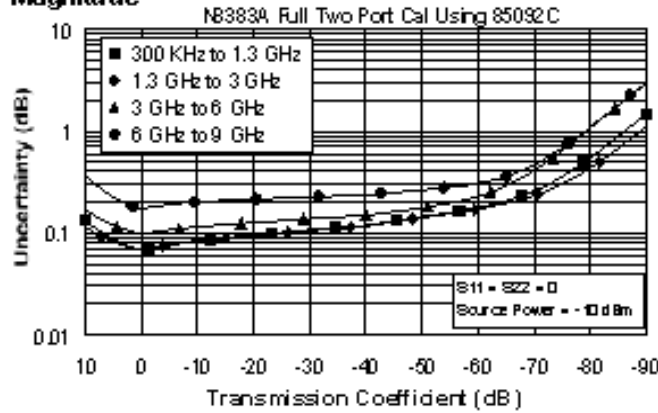

**Phase**

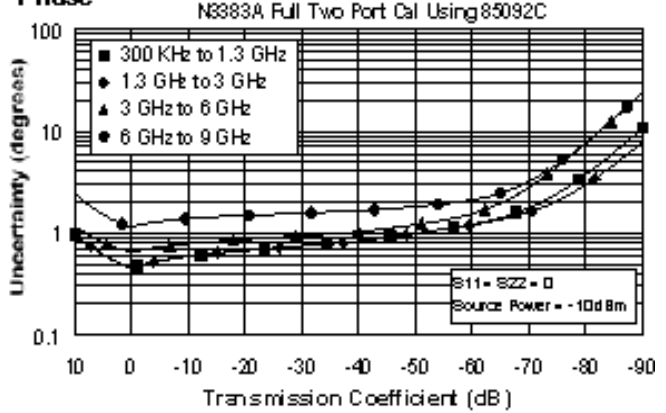

**Reflection Uncertainty (Specifications)**

**Magnitude**

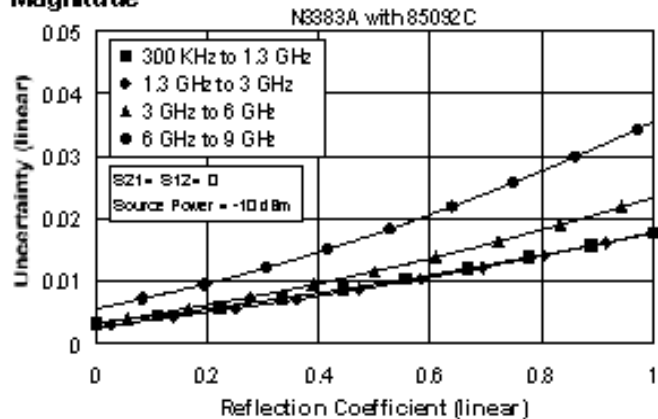

**Phase**

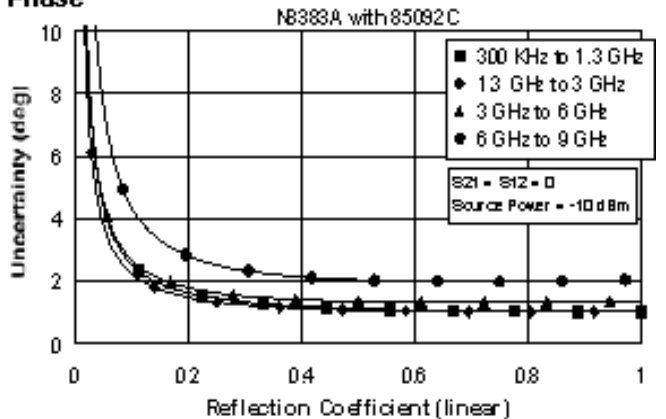

## Corrected System Performance with 3.5 mm Connectors

**Table 4. Corrected System Performance With 3.5 mm Device Connector Type, 85033E Calibration Kit**

Applies to the N3381A, N3382A, and N3383A analyzer, 85033E (3.5 mm, 50Ω) calibration kit, N6314A test port cable, and a full 2-port calibration. Also applies to the following conditions:

- IF bandwidth = 10 Hz
- No averaging applied to data
- Environmental temperature 25° ±5 °C, with < 1 °C deviation from calibration temperature
- Isolation calibration not omitted

Description	Specification (dB)			
	300 kHz to 1.3 GHz	1.3 GHz to 3 GHz	3 to 6 GHz	6 to 9 GHz
Directivity	46	44	38	38
Source Match	43	40	37	36
Load Match	46	44	38	38
Reflection Tracking	±0.006	±0.007	±0.009	±0.010
Transmission Tracking	±0.012	±0.021	±0.057	±0.075

### Transmission Uncertainty (Specifications)

#### Magnitude

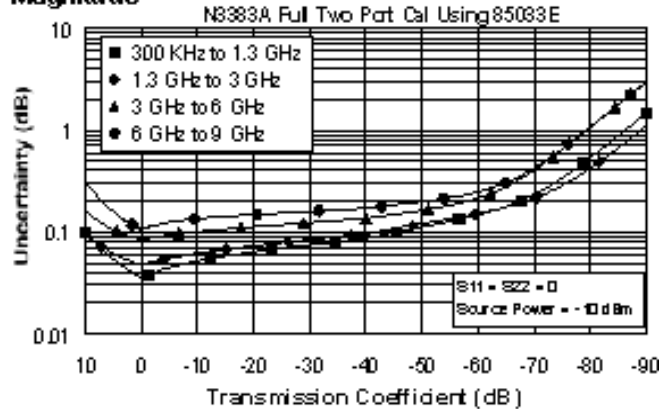

#### Phase

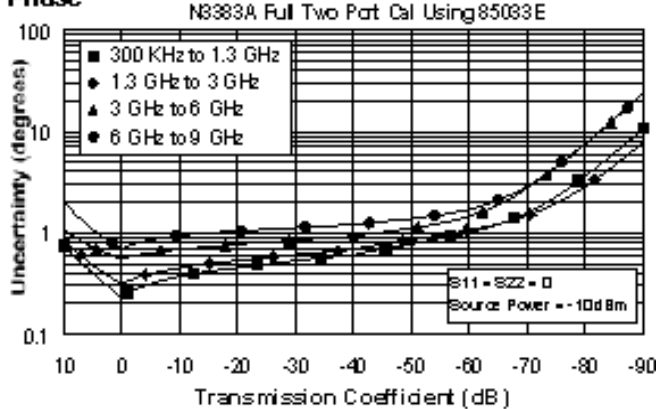

### Reflection Uncertainty (Specifications)

#### Magnitude

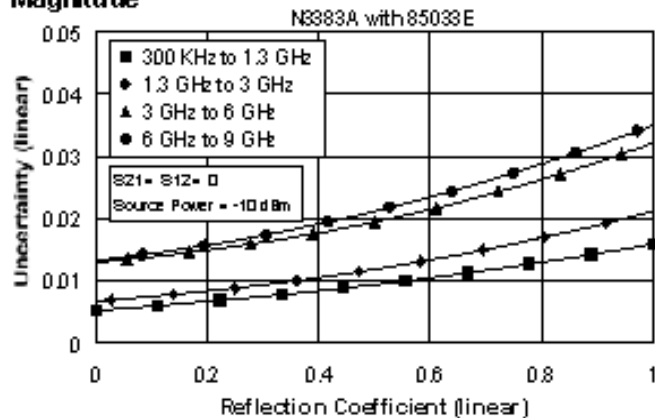

#### Magnitude

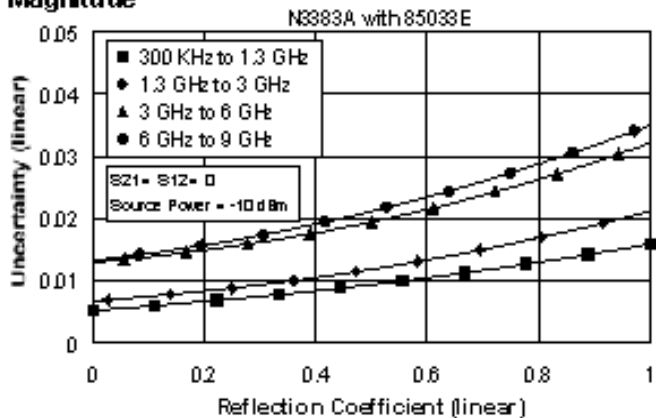

**Table 5. Corrected System Performance With 3.5 mm Device Connector Type, 85093C Electronic Calibration Module**

Applies to the N3381A, N3382A, and N3383A analyzer, 85093C (3.5 mm, 50Ω) electronic calibration (ECal) module, N6314A test port cable, and a full 2-port calibration. Also applies to the following conditions:

- IF bandwidth = 10 Hz
- No averaging applied to data
- Environmental temperature 25° ±5 °C, with < 1 °C deviation from calibration temperature
- Isolation calibration not omitted

Description	Specification (dB)			
	300 kHz to 1.3 GHz	1.3 GHz to 3 GHz	3 to 6 GHz	6 to 9 GHz <sup>a</sup>
Directivity	52	52	51	47
Source Match	44	44	39	34
Load Match	47	47	44	40
Reflection Tracking	±0.030	±0.040	±0.050	±0.070
Transmission Tracking	±0.039	±0.049	±0.068	±0.117

**Transmission Uncertainty (Specifications)**

**Magnitude**

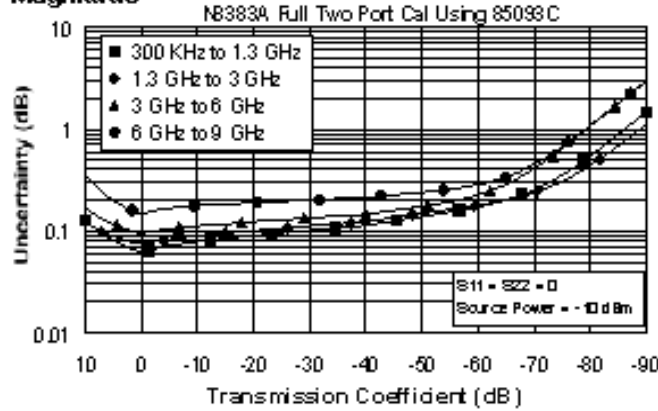

**Phase**

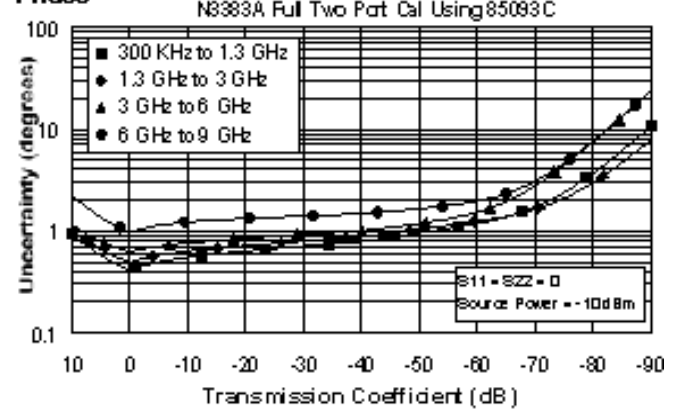

**Reflection Uncertainty (Specifications)**

**Magnitude**

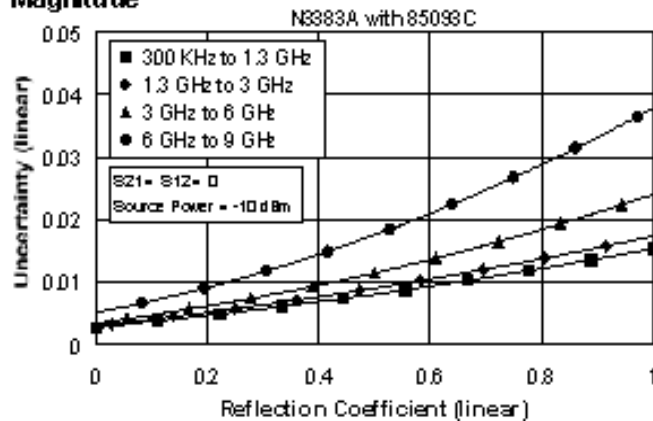

**Phase**

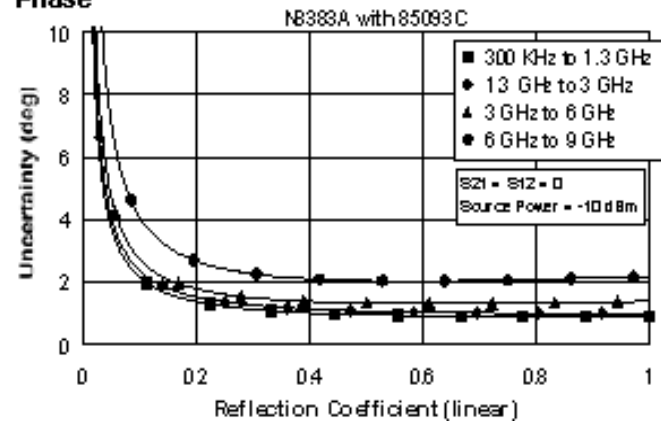



**Table 6. Corrected System Performance With 7-16 Device Connector Type, 85038A Calibration Kit**

Applies to the N3381A, N3382A, and N3383A analyzer, 85038A (7-16, 50Ω) calibration kit, N6314A test port cable, and a full 2-port calibration. Also applies to the following conditions:

- IF bandwidth = 10 Hz
- No averaging applied to data
- Environmental temperature 25° ±5 °C, with < 1 °C deviation from calibration temperature
- Isolation calibration not omitted

Description	Specification (dB)			
	300 kHz to 1.3 GHz	1.3 GHz to 3 GHz	3 to 6 GHz	6 to 9 GHz <sup>a</sup>
Directivity	40	40	36	36
Source Match	37	37	34	34
Load Match	39	39	35	35
Reflection Tracking	±0.089	±0.089	±0.115	±0.115
Transmission Tracking	±0.024	±0.033	±0.082	±0.103

**Transmission Uncertainty (Specifications)**

**Magnitude**

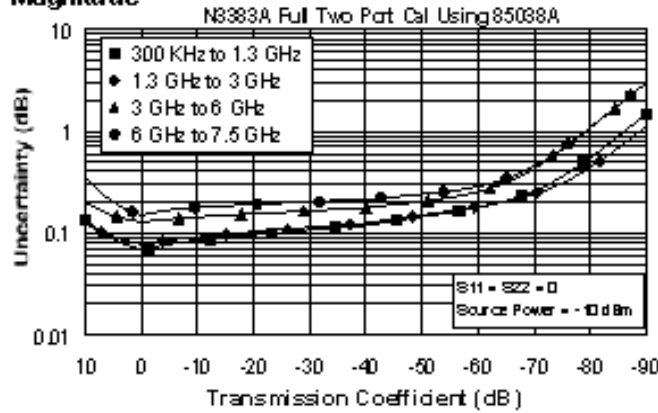

**Phase**

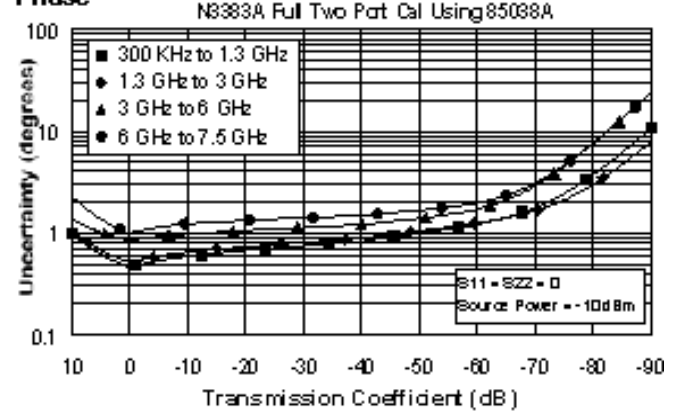

**Reflection Uncertainty (Specifications)**

**Magnitude**

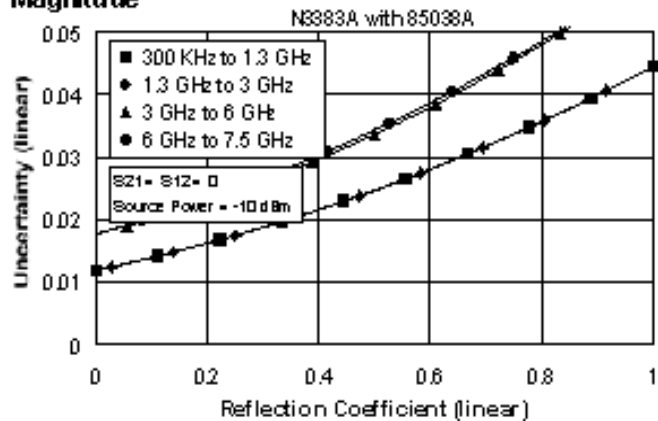

**Phase**

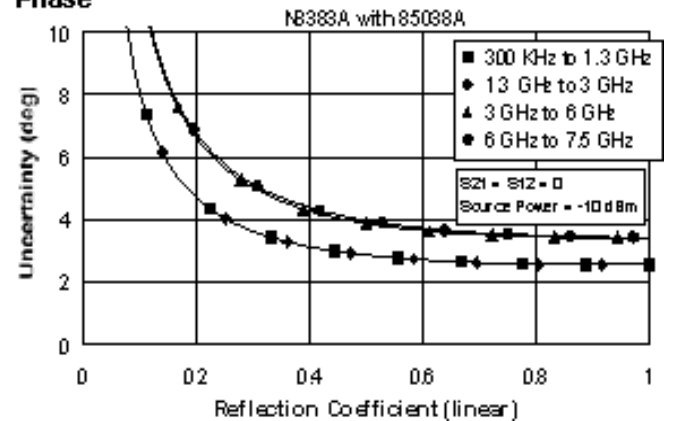

**Table 7. Uncorrected Instrument Performance**

Description	Specification (dB)				
	300 kHz to 1 MHz	1MHz to 1.3 GHz	1.3 GHz to 3 GHz	3 GHz to 6 GHz	6 GHz to 9 GHz
Directivity	30	33	27	20	13
Source Match Ports 1 and 2	18	18	17	14	12
Source Match Port 3 only	18	18	17	14	12
Load Match Ports 1 and 2	20	20	17	13.5	11.5
Load Match Port 3 only	20	20	17	13.5	11.5
Reflection Tracking	±1.5	±1.5	±1.5	±2.5	±3.0
Transmission Tracking	±1.5	±1.5	±1.5	±2.5	±3.0

### Test Port Output Characteristics (Source)

**Table 8. Test Port Output Frequency**

Description	Specification	Supplemental Information
<b>Range:</b>		
N3381A	300 kHz to 3.0 GHz	
N3382A	300 kHz to 6.0 GHz	
N3383A	300 kHz to 9.0 GHz	
<b>Resolution</b>	1 Hz	
<b>Source Stability</b>		±1 ppm, 0° to 40 °C, typical ±1ppm/year maximum
<b>Source Stability (Option 1E5)</b>		±0.05 ppm, 0° to 40 °C, typical ±0.1 ppm/year maximum
<b>CW Accuracy</b>	±3 ppm	
<b>CW Accuracy (Option 1E5)</b>	±1 ppm	

**Table 9. Test Port Output Power<sup>a</sup>**

Description	Specification	Supplemental Information
<b>Level Accuracy</b>		
		Variation from 0 dBm in power range 0 (step attenuator at 0 dB) ±1.5dB below 10 MHz
300 kHz to 6 GHz	±1.0 dB	
6 GHz to 9 GHz	±2.0 dB	
<b>Level Linearity</b>		
		Variation from 0 dBm in power range 0
300 kHz to 9 GHz	±0.3 dB	-15 to +5 dBm
300 kHz to 1 MHz	±1.0 dB	+5 to +10 dBm
1 MHz to 6 GHz	±0.5 dB	+5 to +10 dBm
6 GHz to 9 GHz	±0.5 dB	+5 to +7 dBm
<b>Range<sup>b</sup></b>		
300 kHz to 6 GHz	-15 to +10 dBm	
6 GHz to 9 GHz	-15 to +7 dBm	
<b>Range<sup>b</sup> (Option 1E1)</b>		
300 kHz to 6 GHz	-85 to +10 dBm	
6 GHz to 9 GHz	-85 to +7 dBm	
<b>Sweep Range</b>		
Port 1:		
300 kHz to 6 GHz	25 dB	
6 GHz to 9 GHz	22 dB	
<b>Level Resolution</b>		
	0.01 dB	

<sup>a</sup> Source output performance on port 1 only. Port 2 and port 3 output performance is typically 3 dB less.

<sup>b</sup> Power to which the source can be set and phase lock is assured.

**Table 10. Test Port Output Signal Purity**

Description	Specification	Supplemental Information
<b>Harmonics (2nd or 3rd)</b>		
at max output power (< 25 MHz)		< -25 dBc, typical
at max output power (25 MHz to 9 GHz)		< -25 dBc, characteristic <sup>a</sup>
at 0 dBm output		< -35 dBc, typical
at -10 dBm output		< -38 dBc, typical, in power range 0
<b>Non-harmonic Spurious</b>		
at max output		-30 dBc, typical for offset freq > 1kHz
at -10 dBm output		-50 dBc, typical for offset freq > 1kHz

<sup>a</sup> Typical below 25 MHz.

## Test Port and Receiver Input Characteristics

Table 11. Test Port and Receiver Input Levels

Description	Specification	Supplemental Information
<b>Maximum Test Port Input Level</b>		
300 kHz to 25 MHz	+10 dBm	<0.6 dB compression
25 MHz to 3 GHz	+10 dBm	<0.4 dB compression
3 GHz to 6 GHz	+10 dBm	<0.7 dB compression
6 GHz to 9 GHz	+7 dBm	<0.7 dB compression
<b>Damage Level</b>		
Test Port 1, 2, 3		+30 dBm or $\pm 30$ VDC, typ.
R, A, B, C (Opt. 014)		+15 dBm or $\pm 5$ VDC, typ.
Coupler Thru (Opt. 014)		+33 dBm or $\pm 0$ VDC, typ.
<b>Test Port Noise Floor<sup>a</sup></b>		
300 kHz to 25 MHz <sup>b</sup>		
10 Hz IF Bandwidth	-115 dBm	
1 kHz IF Bandwidth	-95 dBm	
25 MHz to 3 GHz <sup>b</sup>		
10 Hz IF Bandwidth	-118 dBm	
1 kHz IF Bandwidth	-98 dBm	
3 GHz to 9 GHz		
10 Hz IF Bandwidth	$\leq -108$ dBm	
1 kHz IF Bandwidth	$\leq -88$ dBm	
<b>Receiver Noise Floor<sup>a</sup></b>		
300 kHz to 25 MHz <sup>c</sup>		
10 Hz IF Bandwidth	$\leq -130$ dBm, characteristic	
1 kHz IF Bandwidth	$\leq -110$ dBm, characteristic	
25 MHz to 3 GHz <sup>c</sup>		
10 Hz IF Bandwidth	-133 dBm, characteristic	
1 kHz IF Bandwidth	-113 dBm, characteristic	
6 GHz to 9 GHz		
10 Hz IF Bandwidth	$\leq -123$ dBm, characteristic	
1 kHz IF Bandwidth	$\leq -103$ dBm, characteristic	

<b>Crosstalk</b>		
<b>(S<sub>21</sub>, S<sub>31</sub>):</b>		
300 kHz to 1 MHz	<-120 dB	
1 MHz to 25 MHz	<-125 dB	
25 MHz to 3 GHz	<-126 dB	
3 GHz to 6 GHz	<-117 dB	
6 GHz to 9 GHz	<-106 dB	
<b>(S<sub>12</sub>, S<sub>13</sub>):</b>		
300 kHz to 1 MHz	<-120 dB	
1 MHz to 25 MHz	<-125 dB	
25 MHz to 3 GHz	<-126 dB	
3 GHz to 6 GHz	<-113 dB	
6 GHz to 9 GHz	<-106 dB	
<b>(S<sub>23</sub>, S<sub>32</sub>):</b>		
300 kHz to 1 MHz	<-120 dB	
1 MHz to 3 GHz	<-125 dB	
3 GHz to 6 GHz	<-115 dB	
6 GHz to 9 GHz	<-107 dB	
<b>Maximum Receiver Input Level (A, B, R, C)</b>		
300 kHz to 6 GHz		6 dBm, typical
6 GHz to 9 GHz		9 dBm, typical
<b>Reference Input Level (R)<sup>d</sup></b>		
300 kHz to 9 GHz		-10 to -35 dBm, typical
<b>Maximum Coupler Input Level (Opt 014)</b>		
300 kHz to 9 GHz		+33 dBm, typical

<sup>a</sup> Total average (RMS) noise power calculated as the mean value of a linear magnitude trace expressed in dBm.

<sup>b</sup> May be limited to -90 dBm at particular frequencies below 750 MHz due to spurious receiver residuals.

<sup>c</sup> May be limited to -105 dBm at particular frequencies below 750 MHz due to spurious receiver residuals.

<sup>d</sup> Input level to maintain phase lock.

**Table 12. Test Port Input (Trace Noise)**

Description	Specification	Supplemental Information
<b>Trace Noise<sup>a</sup> Magnitude</b>		
1 kHz IF Bandwidth	< 0.002 dB rms	
10 kHz IF Bandwidth	< 0.005 dB rms	
<b>Trace Noise<sup>a</sup> Phase</b>		
1 kHz IF Bandwidth	< 0.010° rms	
10 kHz IF Bandwidth	< 0.035° rms	

<sup>a</sup> Trace noise is defined as a ratio measurement of a through or a full reflection, with the source set to 0 dBm.

**Table 13. Test Port Input (Reference Level and Stability)**

Description	Specification	Supplemental Information
<b>Reference Level Magnitude</b>		
Range	±200 dB	
Resolution	0.001 dB	
<b>Reference Level Phase</b>		
Range	±500°	
Resolution	0.01°	
<b>Stability Magnitude<sup>a</sup></b>		
300 kHz to 3 GHz		0.02 dB/°C, typical
3 GHz to 6 GHz		0.04 dB/°C, typical
6 GHz to 9 GHz		0.06 dB/°C, typical
<b>Stability Phase<sup>a</sup></b>		
300 kHz to 3 GHz		0.2°/°C, typical
3 GHz to 6 GHz		0.3°/°C, typical
6 GHz to 9 GHz		0.6°/°C, typical

<sup>a</sup> Stability is defined as a ratio measurement at the test port.

**Table 14. Test Port Input (Dynamic Accuracy specification<sup>a</sup>)**

Accuracy of the test port input power reading is relative to the reference input power level. Applies to input ports 1 and 2 with the following conditions:

- IF bandwidth = 10 Hz
- Environmental temperature 25° ±5 °C, with < 1 °C deviation from calibration temperature

300 kHz to 3 GHz

300 kHz to 3 GHz

**Magnitude**

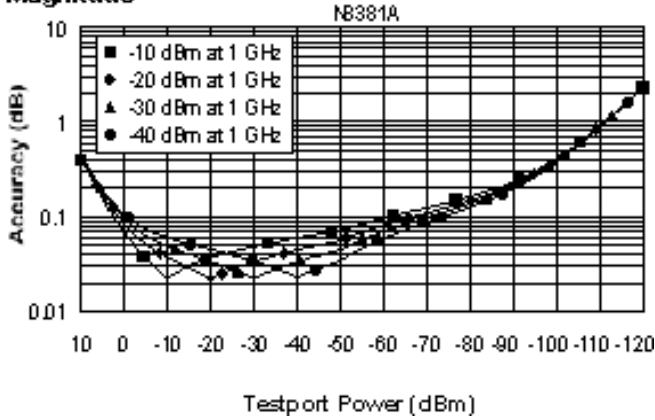

**Phase**

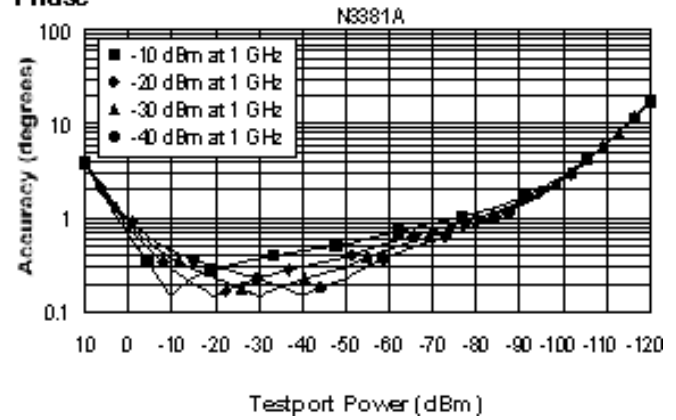

300 kHz to 6 GHz

300 kHz to 6 GHz

**Magnitude**

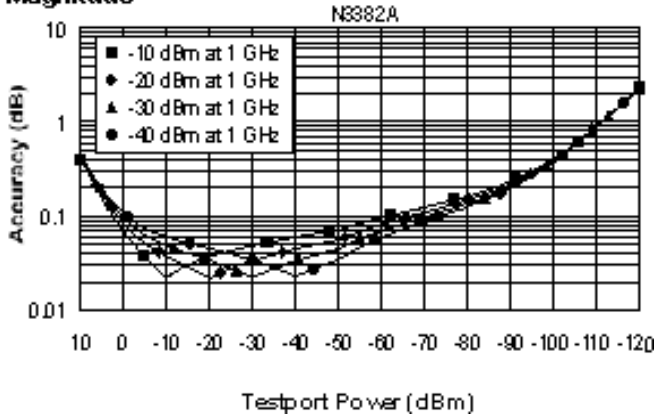

**Phase**

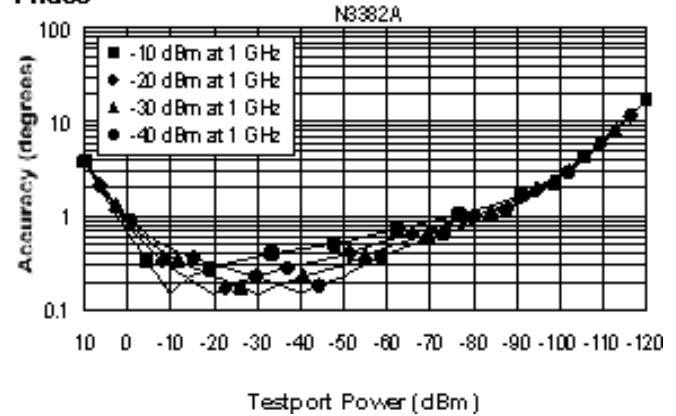

**Magnitude**

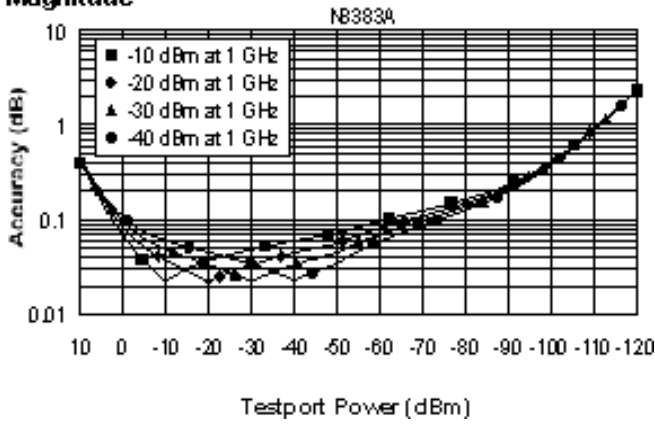

**Phase**

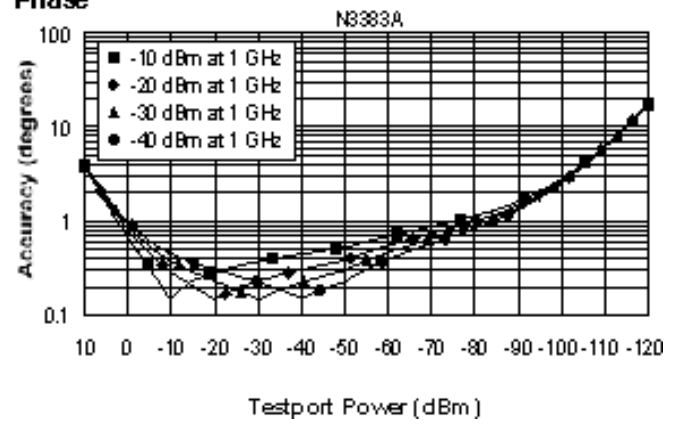

<sup>a</sup>Dynamic accuracy is verified with the following measurements:

- compression over frequency
- IF linearity at a single frequency of 1.195 GHz and a reference level of -20 dBm

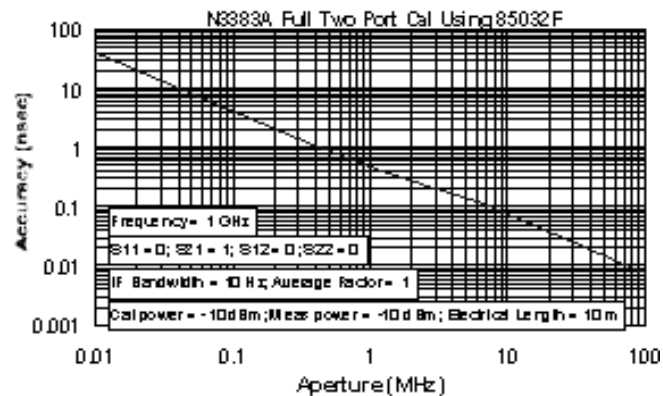

**Table 15. Test Port Input (Group Delay)<sup>a</sup>**

Description	Specification	Supplemental Information
Aperture (selectable)	(frequency span)/(number of points -1)	
Maximum Aperture	20% of frequency span	
Range	0.5 x (1/minimum aperture)	
Maximum Delay		Limited to measuring no more than 180° of phase change within the minimum aperture.)
Accuracy		See graph below. Char.

The following graph shows group delay accuracy with type-N full 2-port calibration and a 10 Hz IF bandwidth. Insertion loss is assumed to be < 2 dB and electrical length to be ten meters.

**Group Delay (Typical)**



In general, the following formula can be used to determine the accuracy, in seconds, of specific group delay measurement:

$$\pm \text{Phase Accuracy (deg)} / [360 \times \text{Aperture (Hz)}]$$

Depending on the aperture and device length, the phase accuracy used is either incremental phase accuracy or worst case phase accuracy.

<sup>a</sup> Group delay is computed by measuring the phase change within a specified frequency step (determined by the frequency span and the number of points per sweep).

## General Information

Table 16. System Bandwidths

Description	Specification	Supplemental Information
<b>IF Bandwidth Settings</b>		
Range		1 Hz to 40 kHz in a 1, 2, 3, 5, 7, 10 sequence up to 30 kHz, 35 kHz, 40kHz, nominal

Table 17. Front Panel Information

Description	Supplemental Information
<b>RF Connectors</b>	
Type	Type-N, female; 50 $\Omega$ , nominal
Center Pin Protrusion	0.204 to 0.207 in., characteristic
<b>Probe Power</b>	
Connector	3-pin connector, male
Positive Supply	+15 VDC $\pm$ 2%, 400 mA, max, characteristic
Negative Supply	-12.6 VDC $\pm$ 5%, 300 mA, max, characteristic
<b>Display</b>	
Size	21.3 cm (8.4 in) diagonal color active matrix LCD; 640 (horizontal) X 480 (vertical) resolution
Refresh Rate	Vertical 59.83 Hz; Horizontal 31.41 Hz
<b>Display Range</b>	
Magnitude	$\pm$ 200 dB (at 20 dB/div), max
Phase	$\pm$ 180°, max
Polar	10 pUnits, min 1000 Units, max
<b>Display Resolution</b>	
Magnitude	0.001 dB/div, min
Phase	0.01°/div, min
<b>Marker Resolution</b>	
Magnitude	0.001 dB, min
Phase	0.01°, min
Polar	0.01 mUnit, min; 0.01°, min

**Table 18. Rear Panel Information**

Description	Supplemental Information
<b>10 MHz Reference In</b>	
Connector	BNC, female
Input Frequency	10 MHz $\pm$ 1 ppm, typical
Input Level	-15 dBm to +20 dBm, typical
Input Impedance	200 $\Omega$ , nom.
<b>10 MHz Reference Out</b>	
Connector	BNC, female
Output Frequency	10 MHz $\pm$ 10 ppm, typical
Signal Type	Sine Wave, typical
Output Level	+10 dBm $\pm$ 4 dB into 50 $\Omega$ , typical
Output Impedance	50 $\Omega$ , nominal
Harmonics	<-40 dBc, typical
<b>VGA Video Output</b>	
Connector	15-pin mini D-Sub; Drives VGA compatible monitors
Devices Supported:	Resolutions:
Flat Panel (TFT)	1024 X 768, 800 X 600, 640 X 480
Flat Panel (DSTN)	800 X 600, 640 X 480
CRT Monitor	1280 X 1024, 1024 X 768, 800 X 600, 640 X 480
	Simultaneous operation of the internal and external displays is allowed, but with 640 X 480 resolution only. If you change resolution, you can only view the external display (internal display will "white out").
<b>Test Set IO</b>	25-pin D-Sub connector, available for external test set control
<b>Aux IO</b>	25-pin D-Sub connector, male, analog and digital IO
<b>Handler IO</b>	36-pin IDC D-ribbon socket connector; all input/output signals are default set to negative logic; can be reset to positive logic via GPIB command
<b>GPIB</b>	24-pin D-sub (Type D-24), female; compatible with IEEE-488.
<b>Parallel Port (LPT1)</b>	25-pin D-Sub connector, female; provides connection to printers or any other parallel port peripherals
<b>Serial Port (COM 1)</b>	9-pin D-Sub, male; compatible with RS-232
<b>USB Port</b>	
	Universal Serial Bus jack, Type A configuration (4 contacts inline, contact 1 on left); female
Contact 1	Vcc: 4.75 to 5.25 VDC, 500 mA, maximum
Contact 2	-Data
Contact 3	+Data
Contact 4	Ground
<b>LAN</b>	10/100BaseT Ethernet, 8-pin configuration; auto selects between the two data rates
<b>Line Power<sup>a, b</sup></b>	
Frequency at 110/115 V	50/60/400 Hz
Frequency at 230/240 V	50/60Hz
Maximum Watts	350 W

<sup>a</sup> A third-wire ground is required.

<sup>b</sup> Power supply has a voltage autoswitching feature.

**Table 19. Rear Panel Information (continued)**

<b>Description</b>	<b>Supplemental Information</b>
<b>External AM Input</b>	
Description	Input provides low-frequency AM modulation to test port output signal, or shifts the test port output. Zero volts input gives the power level set by the instrument, a positive voltage gives a higher level, and a negative voltage gives a lower level.
Connector	BNC, female
Input Sensitivity	8 dB/V, typical
Bandwidth	1 kHz, typical
Input Impedance	1 k $\Omega$ , nominal
<b>External Detector Input</b>	
Description	Input from an external, negative polarity diode detector provides ALC for a test port remote from instrument's front panel
Connector	BNC, female
Input Sensitivity	-500 mV yields approximately -3 dBm at detector's input, typical
Bandwidth	50 kHz, typical
Input Impedance	1 k $\Omega$ , typical

**Table 20. Analyzer Environment and Dimensions**

<b>Description</b>	<b>Supplemental Information</b>		
<b>General Environmental</b>			
RFI/EMI Susceptibility	Defined by CISPR Pub. 11, Group 1, Class A, and IEC 50082-1		
ESD	Minimize using static-safe work procedures and an antistatic bench mat		
Dust	Minimize for optimum reliability		
<b>Operating Environment</b>			
Temperature	0 °C to +40 °C Instrument powers up, phase locks, and displays no error messages within this temperature range.		
Error-Corrected Temperature Range	25°C ± 5°C with less than 1°C deviation from calibration temp.		
Humidity	5% to 95% at +40 °C		
Altitude	0 to 4500 m (14,760 ft.)		
<b>Non-Operating Storage Environment</b>			
Temperature	-40 °C to +70 °C		
Humidity	0% to 90% at +65 °C (non-condensing)		
Altitude	0 to 15,240 m (50,000 ft.)		
<b>Cabinet Dimensions</b>			
	<b>Height</b>	<b>Width</b>	<b>Depth</b>
Excluding front and rear panel hardware and feet	222 mm 8.75 in	425 mm 16.75 in	426 mm 16.8 in
As shipped - includes front panel connectors, rear panel bumpers, and feet.	242 mm 9.5 in	425 mm 16.75 in	470 mm 18.5 in
As shipped plus handles	242 mm 9.5 in	458 mm 18 in	502 mm 19.75 in
As shipped plus rack-mount flanges	242 mm 9.5 in	483 mm 19 in	470 mm 18.5 in
As shipped plus handles and flanges	242 mm 9.5 in	483 mm 19 in	502 mm 19.75 in
<b>Weight</b>			
Net	24 kg (54 lb), nominal		
Shipping	32 kg (70 lb), nominal		

## Measurement Throughput Summary

Table 21. Typical Cycle Time<sup>a,b</sup> (ms)

	Number of Points			
	101	201	401	1601
<b>Start 1.8 GHz, Stop 2 GHz, 35 kHz IF bandwidth</b>				
Uncorrected, 1-port cal	8	11	17	53
2-Port cal	27	36	55	164
<b>Start 300 kHz, Stop 3 GHz, 35 kHz IF bandwidth</b>				
Uncorrected, 1-port cal	48	54	64	104
2-Port cal	103	119	145	254
<b>Start 300 kHz, Stop 9 GHz, 35 kHz IF bandwidth</b>				
Uncorrected, 1-port cal	45	55	61	99
2-Port cal	99	119	133	212

<sup>a</sup> Typical performance.

<sup>b</sup> Includes sweep time, retrace time and band-crossing time. Analyzer display turned off with DISPLAY:ENABLE OFF. Add 21 ms for display on. Data for one trace (S11) measurement.

<sup>c</sup> Option 010 only. Analyzer display turned off with DISPLAY:ENABLE OFF. Add 21 ms for display on. Data for one trace (S11) measurement.

Table 22. Cycle Time vs. IF Bandwidth<sup>a</sup>

Applies to the Preset condition (201 points, correction off) except for the following changes:

- CF = 1 GHz
- Span = 100 MHz
- Display off (add 21 ms for display on)

IF Bandwidth (Hz)	Cycle Time (ms) <sup>b</sup>
40,000	8
35,000	9
30,000	11
20,000	13
10,000	28
7000	36
5000	48
3000	72
1000	196
300	620
100	1875
30	8062
10	17877

<sup>a</sup> Typical performance.

<sup>b</sup> Cycle time includes sweep and retrace time.

**Table 23. Cycle Time vs. Number of Points<sup>a</sup>**

Applies to the Preset condition (35 kHz IF bandwidth, correction off) except for the following changes:

- CF = 1 GHz
- Span = 100 MHz
- Display off (add 21 ms for display on)

<b>Number of Points</b>	<b>Cycle Time (ms)<sup>b</sup></b>
3	4
11	4
51	5
101	6
201	9
401	16
801	29
1601	52

<sup>a</sup> Typical performance.

<sup>b</sup> Cycle time includes sweep and retrace time.

**Table 24. Data Transfer Timea (ms)**

	Number of Points			
	51	201	401	1601
<b>SCPI over GPIB</b>				
<b>(program executed on external PC)<sup>b</sup></b>				
32-bit floating point	3	7	12	43
64-bit floating point	4	12	22	84
ASCII	7	64	124	489
<b>SCPI over 100 Mbit/s LAN</b>				
<b>(program executed on external PC)<sup>b</sup></b>				
32-bit floating point	1	1	1	1
64-bit floating point	1	1	1	2
ASCII	5	15	26	96
<b>SCPI (program executed in the analyzer)<sup>d</sup></b>				
32-bit floating point	1	1	2	3
64-bit floating point	1	2	2	4
ASCII	8	29	56	222
<b>COM (program executed in the analyzer)<sup>e</sup></b>				
32-bit floating point	1	1	1	1
Variant type	1	1	2	6
<b>DCOM over 100 Mbit/s LAN</b>				
<b>(program executed on external PC)<sup>f</sup></b>				
32-bit floating point <sup>g</sup>	1	1	1	2
Variant type <sup>h</sup>	1	3	6	19

<sup>a</sup> Typical performance of unit with 500 MHz Pentium III processor.

<sup>b</sup> Measured using a VEE 5.0 program running on a 600 MHz HP Kayak, National Instruments™ GPIB card. Transferred complex S11 data, using "CALC:DATA?SDATA".

<sup>c</sup> Measured using a VEE 5.0 program running on a 600 MHz HP Kayak. Transferred complex S11 data, using "CALC:DATA?SDATA". Speed dependent on LAN traffic, if connected to network.

<sup>d</sup> Measured using a VEE 5.0 program running inside PNA Series Analyzer. Transferred complex S11 data, using "CALC:DATA?SDATA".

<sup>e</sup> Measured using a Visual Basic 6.0 program running inside PNA Series Analyzer. Transferred complex S11 data.

<sup>f</sup> Measured using a Visual Basic 6.0 program running on a 600 MHz HP Kayak. Transferred complex S11 data. Speed dependent on LAN traffic, if connected to network.

<sup>g</sup> Used IArray Transfer.getComplex method for 32-bit floating point.

<sup>h</sup> Used meas.getData method for Variant data type.



**Table 25. Recall and Sweep Speed<sup>a</sup>**

<b>Operations</b>	<b>Number of Window(s)</b>	<b>Number of Trace(s)</b>	<b>Recall Time (ms)</b>
Recall	1	1	49
Recall and Sweep	1	1	59
Recall	1	2	82
Recall and Sweep	1	2	96
Recall	1	4	159
Recall and Sweep	1	4	203
Recall	2	2	93
Recall and Sweep	2	2	115
Recall	3	4	158
Recall and Sweep	3	4	218
Recall	4	4	187
Recall and Sweep	4	4	247
Recall	4	8	340
Recall and Sweep	4	8	507

<sup>a</sup>CF=177MHz, Span=200 MHz, 201 points, 35 kHz IF BW

## Specifications: Front-Panel Jumpers

Models N3381A, N3382A, N3383A Option 014

---

### Specifications: Front-Panel Jumpers, Port 1

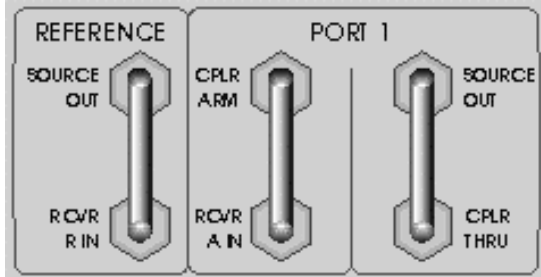

#### Option 014 Analyzer

NOTE: The standard analyzer (N3381A/ N3382A/ N3383A) has no front-panel jumpers.

---

Use these SMA (female) connectors to develop custom measurements.

#### Receiver A Direct-Access Jumper

- The "Cplr Arm" connector comes from the coupled arm of the Port 1 coupler.
- The "Rcvr A In" connector goes directly to the input of receiver "A."

#### For the A Receiver Input:

Maximum Input Level:

- 6 dBm; <0.4 dB Compression (300 kHz to 3 GHz)
- 6 dBm; <0.8 dB Compression (3 GHz to 6 GHz)
- 11 dBm; <0.8 dB Compression (6 GHz to 9 GHz)

Noise Floor; rms (10 Hz Bandwidth):

- <-130 dBm (300 kHz to 25 MHz)
- <-123 dBm (3 GHz to 6 GHz)
- <-123 dBm (6 GHz to 9 GHz)

Damage Level: +15 dBm

Maximum DC Level: +/-5 V

Return Loss:

- >17 dB (300 kHz to 3 GHz)
- >12 dB (3 GHz to 6 GHz)
- >7 dB (6 GHz to 9 GHz)

#### Reference Channel R Jumper

- The "Source Out" connector comes from the source Reference output.
- The "Rcvr R In" connector goes directly to the R receiver input.

**For the R Receiver Input:**

Maximum Input Level:

- 6 dBm; <0.4 dB Compression (300 kHz to 3 GHz)
- 6 dBm; <0.8 dB Compression (3 GHz to 6 GHz)
- 11 dBm; <0.8 dB Compression (6 GHz to 9 GHz)

Damage Level: >+15 dBm

Minimum Level to Maintain Phase-Lock:

- 35 dBm (300 kHz to 3 GHz)
- 25 dBm (3 GHz to 9 GHz)

For the Reference Output: (with an External Input to Lock the Source)

Output Level:

- 5 to -30 dBm (300 kHz to 6 GHz)
- 10 to -35 dBm (6 GHz to 9 GHz)

Source Match Return Loss:

- 16 dB (300 kHz to 3 GHz)
- 14 dB (3 GHz to 9 GHz)

Damage Level: >+15 dBm

Maximum DC Level: 40V

**Port 1 Test-Port Jumper**

- The upper "Source Out" connector comes from the transfer switch Port 1 output.
- The lower "Coupler Thru" connector goes directly to the main input of Port 1 coupler. This is where a power amplifier can be inserted to boost the test port power.

**For the Source Output:**

Output Level:

- +12 to -83 dBm (300 kHz to 6 GHz)
- +7 to -88 dBm (6 GHz to 9 GHz)

Source Match: 15 dB at 9 GHz

**For the Input to the Coupler:**

Insertion Loss to Test Port 1:

- <3.5 dB at 3 GHz
- <5 dB at 9 GHz

Maximum Input Power: 2 Watts, CW

Damage Level: 4 Watts, CW

## Specifications: Front-Panel Jumpers, Port 2 and Port 3

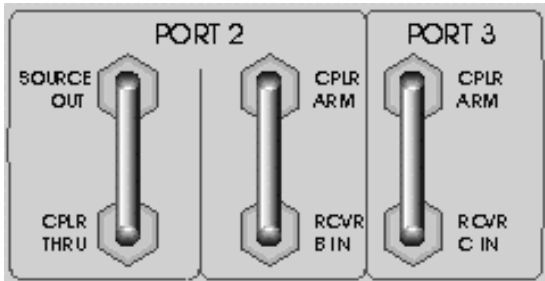

### Option 014 Analyzer

NOTE: The standard analyzer (N3381A/ N3382A/ N3383A) has no front-panel jumpers.

Use these SMA (female) connectors to develop custom measurements.

#### Receiver B Direct-Access Jumper

- The upper "Cplr Arm" connector comes from the coupled arm of the Port 2 coupler.
- The "Rcvr B In" connector goes directly to the input of receiver "B."

For the B Receiver Input:

Maximum Input Level:

- 6 dBm; <0.4 dB Compression (300 kHz to 3 GHz)
- 6 dBm; <0.8 dB Compression (3 GHz to 6 GHz)
- 11 dBm; <0.8 dB Compression (6 GHz to 9 GHz)

Noise Floor; rms (10 Hz Bandwidth):

- <-130 dBm (300 kHz to 25 MHz)
- <-123 dBm (3 GHz to 6 GHz)
- <-123 dBm (6 GHz to 9 GHz)

Damage Level: +15 dBm

Maximum DC Level: +/-5 V

Return Loss:

- >17 dB (300 kHz to 3 GHz)
- >12 dB (3 GHz to 6 GHz)
- >7 dB (6 GHz to 9 GHz)

#### Port 2 Test-Port Jumper

- The upper "Source Out" connector comes from the transfer switch Port 2 output.
- The lower "Coupler Thru" connector goes directly to the main input of Port 2 coupler. This is where a power amplifier can be inserted to boost the test port power.

#### For the Source Output:

Output Level:

- +10 to -85 dBm (300 kHz to 6 GHz)
- +7 to -88 dBm (6 GHz to 9 GHz)

Source Match: 15 dB at 9 GHz

**For the Input to the Coupler:**

Insertion Loss to Test Port 2:

- <3.5 dB at 3 GHz
- <5 dB at 9 GHz

Maximum Input Power: 2 Watts, CW

Damage Level: 4 Watts, CW

**Receiver C Direct-Access Jumper**

- The upper "Cplr Arm" connector comes from the coupled arm of the Port 3 coupler.
- The "Rcvr C In" connector goes directly to the input of receiver "C."

**For the C Receiver Input:**

Maximum Input Level:

- 6 dBm; <0.4 dB Compression (300 kHz to 3 GHz)
- 6 dBm; <0.8 dB Compression (3 GHz to 6 GHz)
- 11 dBm; <0.8 dB Compression (6 GHz to 9 GHz)

Noise Floor; rms (10 Hz Bandwidth):

- <-130 dBm (300 kHz to 25 MHz)
- <-123 dBm (6 GHz to 9 GHz)

Damage Level: +15 dBm

Maximum DC Level: +/-5 V

Return Loss:

- >17 dB (300 kHz to 3 GHz)
- >12 dB (3 GHz to 6 GHz)
- >7 dB (6 GHz to 9 GHz)

**N3381A, N3382A, and N3383A Simplified Test Set Block Diagram**

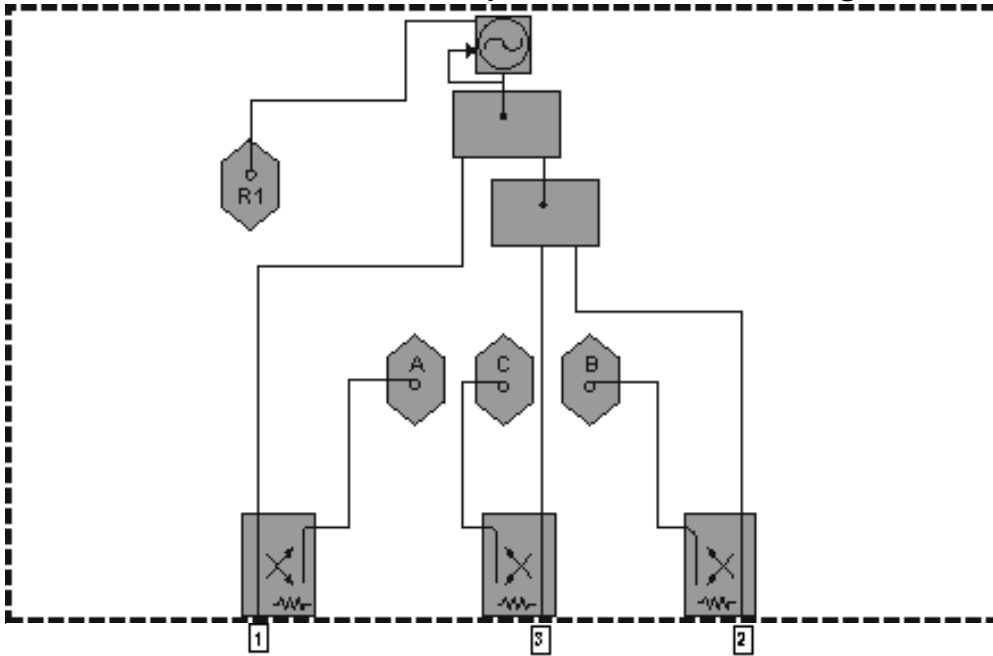

**N3381A, N3382A, and N3383A with Option 014 Simplified Test Set Block Diagram**

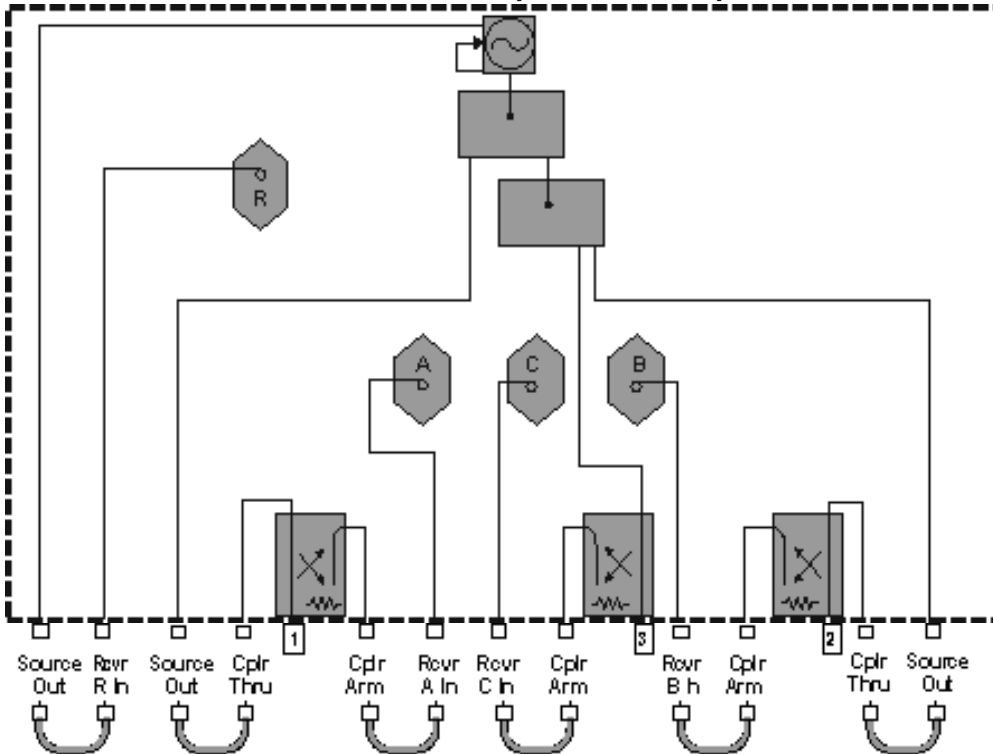

## 4 Technical Specifications for the E836xA

---

<b>Definitions</b> .....	4-4
<b>Corrected System Performance</b> .....	4-5
Table 1. System Dynamic Range <sup>a</sup> .....	4-5
Table 2. Receiver Dynamic Range <sup>a</sup> .....	4-7
<b>E8363/4A Corrected System Performance with 2.4mm Connectors</b> .....	4-8
Table 3. 85056A Calibration Kit Standard Configuration and Standard Power Range (E8363/4A) ..	4-8
Table 4. 85056A Calibration Kit Extended Configuration and Standard Power Range (E8363/4A - Option 014) -OR- Standard Configuration and Extended Power Range & Bias-Tees (E8363/4A - Option UNL) -OR- Extended Configuration and Extended Power Range & Bias-Tees (E8363/4A - Option UNL&014) .....	4-9
Table 5. 85056D Calibration Kit Standard Configuration and Standard Power Range (E8363/4A) ..	4-10
Table 6. 85056D Calibration Kit Extended Configuration and Standard Power Range (E8363/4A - Option 014) -OR- Standard Configuration and Extended Power Range & Bias-Tees (E8363/4A - Option UNL) -OR- Extended Configuration and Extended Power Range & Bias-Tees (E8363/4A - Option UNL & 014) .....	4-11
<b>E8363/4A Corrected System Performance with 2.92mm Connectors</b> .....	4-12
Table 7. 85056K Calibration Kit Standard Configuration and Standard Power Range (E8363/4A) ..	4-12
Table 8. 85056K Calibration Kit Extended Configuration and Standard Power Range (E8363/4A - Option 014) -OR- Standard Configuration and Extended Power Range & Bias-Tees (E8363/4A - Option UNL) -OR- Extended Configuration and Extended Power Range & Bias-Tees (E8363/4A - Option UNL&014) .....	4-13
<b>E836xA Corrected System Performance with 3.5mm Connectors</b> .....	4-14
Table 9. 85052B Calibration Kit Standard Configuration and Standard Power Range (E836xA) ....	4-14
Table 10. 85052B Calibration Kit Extended Configuration and Standard Power Range (E836xA - Option 014) -OR- Standard Configuration and Extended Power Range & Bias-Tees (E836xA - Option UNL) -OR- Extended Configuration and Extended Power Range & Bias-Tees (E836xA - Option UNL&014) .....	4-15
Table 11. 85052C Calibration Kit Standard Configuration and Standard Power Range (E836xA) ..	4-16
Table 12. 85052C Calibration Kit Extended Configuration and Standard Power Range (E836xA - Option 014) -OR- Standard Configuration and Extended Power Range & Bias-Tees (E836xA - Option UNL) -OR- Extended Configuration and Extended Power Range & Bias-Tees (E836xA - Option UNL&014) .....	4-17
Table 13. 85052D Calibration Kit Standard Configuration and Standard Power Range (E836xA) ..	4-18
Table 14. 85052D Calibration Kit Extended Configuration and Standard Power Range (E836xA - Option 014) -OR- Standard Configuration and Extended Power Range & Bias-Tees (E836xA - Option UNL) -OR- Extended Configuration and Extended Power Range & Bias-Tees (E836xA - Option UNL&014) .....	4-19
<b>E836xA Corrected System Performance with 7mm Connectors</b> .....	4-20
Table 15. 85050B Calibration Kit Standard Configuration and Standard Power Range (E836xA) ..	4-20
Table 16. 85050B Calibration Kit Extended Configuration and Standard Power Range (E836xA - Option 014) -OR- Standard Configuration and Extended Power Range & Bias-Tees (E836xA - Option UNL) -OR- Extended Configuration and Extended Power Range & Bias-Tees (E836xA - Option UNL&014) .....	4-21
Table 17. 85050C Calibration Kit Standard Configuration and Standard Power Range (E836xA) ..	4-22
Table 18. 85050C Calibration Kit Extended Configuration and Standard Power Range (E836xA - Option 014) -OR- Standard Configuration and Extended Power Range & Bias-Tees (E836xA - Option UNL) -OR- Extended Configuration and Extended Power Range & Bias-Tees (E836xA - Option UNL&014) .....	4-23
Table 19. 85050D Calibration Kit Standard Configuration and Standard Power Range (E836xA) ..	4-24
Table 20. 85050D Calibration Kit Extended Configuration and Standard Power Range	

(E836xA - Option 014) -OR- Standard Configuration and Extended Power Range & Bias-Tees (E836xA - Option UNL) -OR- Extended Configuration and Extended Power Range & Bias-Tees (E836xA - Option UNL&014).....	4-25
<b>E836xA Corrected System Performance with Type-N Connectors .....</b>	<b>4-26</b>
Table 21. 85054B Calibration Kit Standard Configuration and Standard Power Range (E836xA) ..	4-26
Table 22. 85054B Calibration Kit Extended Configuration and Standard Power Range (E836xA - Option 014) -OR- Standard Configuration and Extended Power Range & Bias-Tees (E836xA - Option UNL) -OR- Extended Configuration and Extended Power Range & Bias-Tees (E836xA - Option UNL&014).....	4-27
Table 23. 85054D Calibration Kit Standard Configuration and Standard Power Range (E836xA) ..	4-28
Table 24. 85054D Calibration Kit Extended Configuration and Standard Power Range (E836xA - Option 014) -OR- Standard Configuration and Extended Power Range & Bias-Tees (E836xA - Option UNL) -OR- Extended Configuration and Extended Power Range & Bias-Tees (E836xA - Option UNL&014).....	4-29
<b>E8363/4A Corrected System Performance with WR-28 Connectors .....</b>	<b>4-30</b>
Table 25. R11644A Calibration Kit Standard Configuration and Standard Power Range (E8363/4A).....	4-30
Table 26. R11644A Calibration Kit Extended Configuration and Standard Power Range (E8363/4A - Option 014) -OR- Standard Configuration and Extended Power Range & Bias-Tees (E8363/4A - Option UNL) -OR- Extended Configuration and Extended Power Range & Bias-Tees (E8363/4A - Option UNL&014).....	4-31
<b>E8363/4A Corrected System Performance with WR-42 Connectors .....</b>	<b>4-32</b>
Table 27. K11644A Calibration Kit Standard Configuration and Standard Power Range (E8363/4A).....	4-32
Table 28. K11644A Calibration Kit Extended Configuration and Standard Power Range (E8363/4A - Option 014) -OR- Standard Configuration and Extended Power Range & Bias-Tees (E8363/4A - Option UNL) -OR- Extended Configuration and Extended Power Range & Bias-Tees (E8363/4A - Option UNL&014).....	4-33
<b>E836xA Corrected System Performance with WR-62 Connectors .....</b>	<b>4-34</b>
Table 29. P11644A Calibration Kit Standard Configuration and Standard Power Range (E836xA)	4-34
Table 30. P11644A Calibration Kit Extended Configuration and Standard Power Range (E836xA - Option 014) -OR- Standard Configuration and Extended Power Range & Bias-Tees (E836xA - Option UNL) -OR- Extended Configuration and Extended Power Range & Bias-Tees (E836xA - Option UNL&014).....	4-35
<b>E836xA Corrected System Performance with WR-90 Connectors .....</b>	<b>4-36</b>
Table 31. X11644A Calibration Kit Standard Configuration and Standard Power Range (E836xA).....	4-36
Table 32. X11644A Calibration Kit Extended Configuration and Standard Power Range (E836xA - Option 014) -OR- Standard Configuration and Extended Power Range & Bias-Tees (E836xA - Option UNL) -OR- Extended Configuration and Extended Power Range & Bias-Tees (E836xA - Option UNL&014).....	4-37
Table 33. Uncorrected System Performance .....	4-38
Table 34. Test Port Output <sup>a</sup> .....	4-40
Table 35. Test Port Input.....	4-42
Table 36. Dynamic Accuracy (Specification <sup>a</sup> ) .....	4-45
Table 37. Test Port Input (Group Delay) <sup>a</sup> .....	4-46
<b>General Information .....</b>	<b>4-46</b>
Table 38. Miscellaneous Information.....	4-46
Table 39. Front Panel Information.....	4-47
Table 40. Rear Panel Information.....	4-47
Table 41. Analyzer Environment and Dimensions.....	4-49
<b>Measurement Throughput Summary.....</b>	<b>4-50</b>



Table 42. Typical Cycle Time <sup>a,b</sup> (ms) for Measurement Completion .....	4-50
Table 43. Cycle Time vs IF Bandwidth <sup>a</sup> .....	4-51
Table 44. Cycle Time vs Number of Points <sup>a</sup> .....	4-51
Table 45. Data Transfer Time (ms) <sup>a</sup> .....	4-52
<b>Specifications: Front-Panel Jumpers</b> .....	<b>4-53</b>
Table 46: Measurement Receiver Inputs (Rcvr A In, Rcvr B In).....	4-53
Table 47: Reference Receiver Inputs (Rcvr R1, Rcvr R2).....	4-55
Table 48: Reference Outputs (Reference 1 Source Out, Reference 2 Source Out).....	4-56
Table 49: Source Outputs (Port 1 Source Out, Port 2 Source Out).....	4-57
Table 50: Coupler Inputs (Port 1 Cplr Thru, Port 2 Cplr Thru) .....	4-58
Table 51: Coupler Outputs (Port 1 Cplr Arm, Port 2 Cplr Arm) .....	4-59
<b>Test Set Block Diagrams</b> .....	<b>4-60</b>
E836xA Standard Configuration and Standard Power Range.....	4-60
E836xA - Option UNL Standard Configuration with Extended Power Range and Bias - Tees.....	4-60
<b>Test Set with Option 014 Block Diagrams</b> .....	<b>4-61</b>
E836xA - Option 014 Extended Configuration and Standard Power Range .....	4-61
E836xA - Option UNL&014 Extended Configuration with Extended Power Range and Bias - Tees .....	4-62

This is a complete list of the E8362A, E8363A, and E8364A network analyzer technical specifications.

- To optimize viewing of uncertainty curves, click the Maximize button.
- To view or print the PNA Series Data Sheet (a condensed version of the specifications), visit our web site at <http://www.agilent.com/find/pna>, select your analyzer model, and click on the link for the data sheet.
- The uncertainty curves contained in this document apply only to the setup conditions listed. Please download our free Uncertainty Calculator from [http://www.agilent.com/find/na\\_calculator](http://www.agilent.com/find/na_calculator) to generate the curves for your PNA setup. View the [equations](#) used to generate the uncertainty curves.

---

See [Specs for other PNA models](#)

---

## Definitions

All specifications and characteristics apply over a 25 °C  $\pm$ 5 °C range (unless otherwise stated) and 90 minutes after the instrument has been turned on.

**Specification (spec.):** Warranted performance. Specifications include guardbands to account for the expected statistical performance distribution, measurement uncertainties, and changes in performance due to environmental conditions.

**Characteristic (char.):** A performance parameter that the product is expected to meet before it leaves the factory, but that is not verified in the field and is not covered by the product warranty. A characteristic includes the same guardbands as a specification.

**Typical (typ.):** Expected performance of an average unit which does not include guardbands. It is not covered by the product warranty.

**Nominal (nom.):** A general, descriptive term that does not imply a level of performance. It is not covered by the product warranty.

**Calibration:** The process of measuring known standards to characterize a network analyzer's systematic (repeatable) errors.

**Corrected (residual):** Indicates performance after error correction (calibration). It is determined by the quality of calibration standards and how well "known" they are, plus system repeatability, stability, and noise.

**Uncorrected (raw):** Indicates instrument performance without error correction. The uncorrected performance affects the stability of a calibration.

**Standard:** When referring to the analyzer, this includes no options unless noted otherwise.

## Corrected System Performance

The specifications in this section apply for measurements made with the E836xA analyzer with the following conditions:

- 10 Hz IF bandwidth
- No averaging applied to data
- Isolation calibration with an averaging factor of 8

Table 1. System Dynamic Range<sup>a</sup>

Description	Specification (dB) at Test Port <sup>b</sup>	Typical (dB) at Direct Receiver Access Input <sup>c</sup>
<b>Dynamic Range (in a 10 Hz BW)</b>		
<b>Standard Configuration and Standard Power Range (E836xA - Standard)</b>		
45 MHz to 500 MHz <sup>d</sup>	94	NA
500 MHz to 2 GHz	119	NA
2 GHz to 10 GHz	122	NA
10 GHz to 20 GHz	123	NA
20 GHz to 30 GHz	114	NA
30 GHz to 40 GHz	110	NA
40 GHz to 45 GHz	109	NA
45 GHz to 50 GHz	104	NA
<b>Extended Configuration and Standard Power Range (E836xA - Option 014)</b>		
45 MHz to 500 MHz <sup>d</sup>	94	132
500 MHz to 2 GHz	119	138
2 GHz to 10 GHz	122	137
10 GHz to 20 GHz	122	137
20 GHz to 30 GHz	115	127
30 GHz to 40 GHz	107	119
40 GHz to 45 GHz	105	116
45 GHz to 50 GHz	100	111
<b>Standard Configuration and Extended Power Range &amp; Bias-Tees (E836xA - Option UNL)</b>		
45 MHz to 500 MHz <sup>d</sup>	92	NA
500 MHz to 2 GHz	117	NA
2 GHz to 10 GHz	120	NA
10 GHz to 20 GHz	121	NA
20 GHz to 30 GHz	112	NA
30 GHz to 40 GHz	108	NA
40 GHz to 45 GHz	105	NA
45 GHz to 50 GHz	99	NA

<b>Standard Configuration and Extended Power Range &amp; Bias-Tees (E836xA - Option UNL&amp;014)</b>		
45 MHz to 500 MHz <sup>d</sup>	92	130
500 MHz to 2 GHz	117	136
2 GHz to 10 GHz	120	135
10 GHz to 20 GHz	119	134
20 GHz to 30 GHz	109	121
30 GHz to 40 GHz	105	117
40 GHz to 45 GHz	101	112
45 GHz to 50 GHz	95	108

<sup>a</sup> The system dynamic range is calculated as the difference between the noise floor and the source maximum output power. The effective dynamic range must take measurement uncertainties and interfering signals into account.

<sup>b</sup> The test port system dynamic range is calculated as the difference between the test port noise floor and the source maximum output power. The effective dynamic range must take measurement uncertainties and interfering signals into account.

<sup>c</sup> The direct receiver access input system dynamic range is calculated as the difference between the receiver access input noise floor and the source maximum output power. The effective dynamic range must take measurement uncertainties and interfering signals into account. This set-up should only be used when the receiver input will never exceed its damage level. When the analyzer is in segment sweep mode, the analyzer can have predefined frequency segments which will output a higher power level when the extended dynamic range is required (i.e. devices with high insertion loss), and reduced power when receiver damage may occur (i.e. devices with low insertion loss). The extended range is only available in one-path transmission measurements.

<sup>d</sup> May be degraded by 10 dB at particular frequencies (multiples of 5 MHz) below 500 MHz due to spurious receiver residuals. Methods are available to regain the full dynamic range.

**Table 2. Receiver Dynamic Range<sup>a</sup>**

Description	Specification (dB) at Test Port <sup>b</sup>	Typical (dB) at Direct Receiver Access Input <sup>c</sup>
<b>Dynamic Range (in a 10 Hz BW)</b>		
<b>Standard Configuration and Standard Power Range (E836xA - Standard)</b>		
<b>OR</b>		
<b>Standard Configuration and Extended Power Range &amp; Bias Tees (E836xA - Option UNL)</b>		
45 MHz to 500 MHz <sup>d</sup>	94	NA
500 MHz to 2 GHz	119	NA
2 GHz to 10 GHz	122	NA
10 GHz to 20 GHz	125	NA
20 GHz to 30 GHz	114	NA
30 GHz to 40 GHz	111	NA
40 GHz to 50 GHz	111	NA
<b>Extended Configuration and Standard Power Range (E836xA - Option 014)</b>		
<b>OR</b>		
<b>Extended Configuration and Extended Power Range &amp; Bias Tees (E836xA - Option UNL&amp;014)</b>		
45 MHz to 500 MHz <sup>d</sup>	94	132
500 MHz to 2 GHz	119	138
2 GHz to 10 GHz	122	137
10 GHz to 20 GHz	124	139
20 GHz to 30 GHz	113	125
30 GHz to 40 GHz	110	122
40 GHz to 50 GHz	109	120

<sup>a</sup> The receiver dynamic range is calculated as the difference between the noise floor and the receiver maximum output power. The effective dynamic range must take measurement uncertainties and interfering signals into account.

<sup>b</sup> The test port receiver dynamic range is calculated as the difference between the test port noise floor and the receiver maximum input level. The effective dynamic range must take measurement uncertainties and interfering signals into account.

<sup>c</sup> The direct receiver access input receiver dynamic range is calculated as the difference between the direct receiver access input noise floor and the receiver maximum input level. The effective dynamic range must take measurement uncertainties and interfering signals into account. This set-up should only be used when the receiver input will never exceed its damage level. When the analyzer is in segment sweep mode, the analyzer can have predefined frequency segments which will output a higher power level when the extended dynamic range is required (i.e. devices with high insertion loss), and reduced power when receiver damage may occur (i.e. devices with low insertion loss). The extended range is only available in one-path transmission measurements.

<sup>d</sup> May be degraded by 10 dB at particular frequencies (multiples of 5 MHz) below 500 MHz due to spurious receiver residuals. Methods are available to regain the full dynamic range.

---

**Note:** This E836xA document provides technical specifications for the following calibration kits only: 85056A, 85056D, 85056K, 85052B, 85052C, 85052D, 85050B, 85050C, 85050D, 85054B, 85054D, K11644A, P11644A, R11644A, and the X11644A.

---

## E8363/4A Corrected System Performance with 2.4mm Connectors

**Table 3. 85056A Calibration Kit  
Standard Configuration and Standard Power Range  
(E8363/4A)**

Applies to the E8363/4A analyzers, 85056A (2.4mm) calibration kit, 85133F flexible test port cable set, and a full 2-port calibration. Also applies to the following condition:

Environmental temperature  $23^{\circ} \pm 3^{\circ} \text{C}$ , with  $< 1^{\circ} \text{C}$  deviation from calibration temperature

Description	Specification (dB)				
	0.045 to 2 GHz	2 to 10 GHz	10 to 20 GHz	20 to 40 GHz	40 to 50 GHz
Directivity	42	42	42	38	36
Source Match	41	38	38	33	31
Load Match	42	42	42	37	35
Reflection Tracking	$\pm 0.001$ $+0.02/^{\circ}\text{C}$	$\pm 0.008$ $+0.02/^{\circ}\text{C}$	$\pm 0.008$ $+0.02/^{\circ}\text{C}$	$\pm 0.020$ $+0.03/^{\circ}\text{C}$	$\pm 0.027$ $+0.04/^{\circ}\text{C}$
Transmission Tracking	$\pm 0.014$ $+0.02/^{\circ}\text{C}$	$\pm 0.033$ $+0.02/^{\circ}\text{C}$	$\pm 0.039$ $+0.02/^{\circ}\text{C}$	$\pm 0.105$ $+0.03/^{\circ}\text{C}$	$\pm 0.200$ $+0.04/^{\circ}\text{C}$

### Transmission Uncertainty (Specifications)

#### Phase

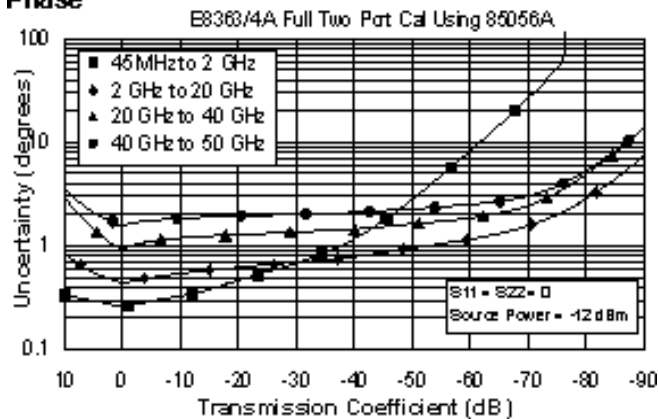

#### Magnitude

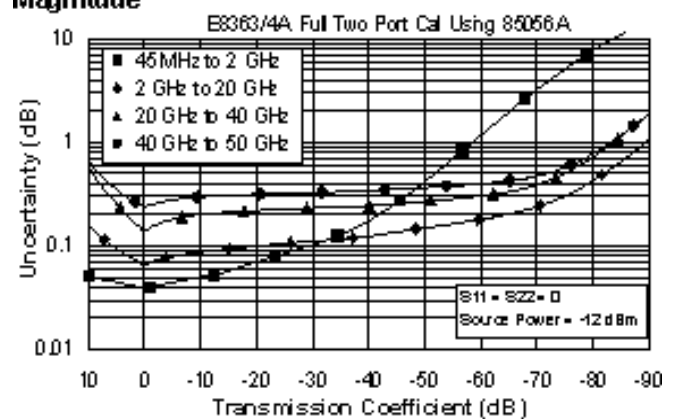

### Reflection Uncertainty (Specifications)

#### Magnitude

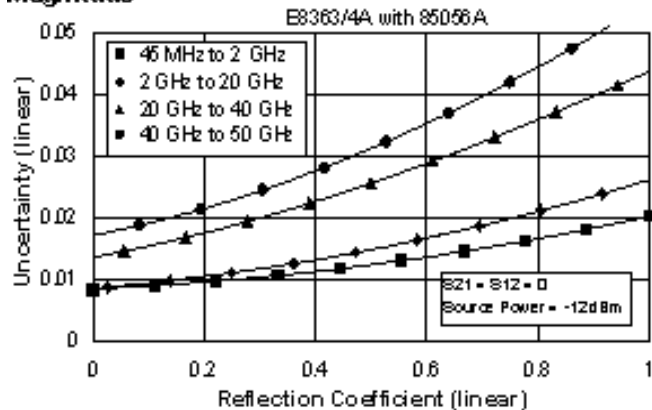

#### Phase

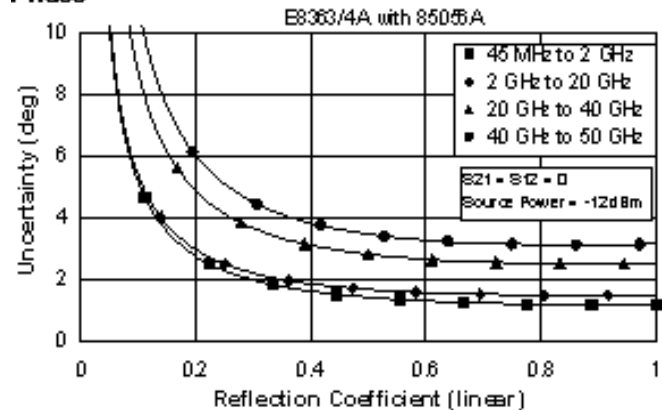

**Table 4. 85056A Calibration Kit**

**Extended Configuration and Standard Power Range (E8363/4A - Option 014)**

-OR-

**Standard Configuration and Extended Power Range & Bias-Tees (E8363/4A - Option UNL)**

-OR-

**Extended Configuration and Extended Power Range & Bias-Tees (E8363/4A - Option UNL&014)**

Applies to the, E8363/4A analyzers, 85056A (2.4mm) calibration kit, 85133F flexible test port cable set, and a full 2-port calibration. Also applies to the following condition:

Environmental temperature 23° ±3 °C, with < 1 °C deviation from calibration temperature

Description	Specification (dB)				
	0.045 to 2 GHz	2 to 10 GHz	10 to 20 GHz	20 to 40 GHz	40 to 50 GHz
Directivity	42	42	42	38	36
Source Match	41	38	38	33	31
Load Match	42	42	42	37	35
Reflection Tracking	±0.001 +0.02/°C	±0.008 +0.02/°C	±0.008 +0.02/°C	±0.020 +0.03/°C	±0.027 +0.04/°C
Transmission Tracking	±0.019 +0.02/°C	±0.039 +0.02/°C	±0.053 +0.02/°C	±0.114 +0.03/°C	±0.215 +0.04/°C

**Transmission Uncertainty (Specifications)**

**Magnitude**

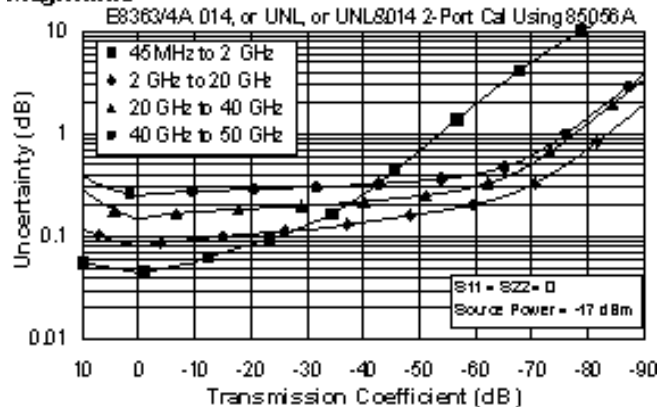

**Phase**

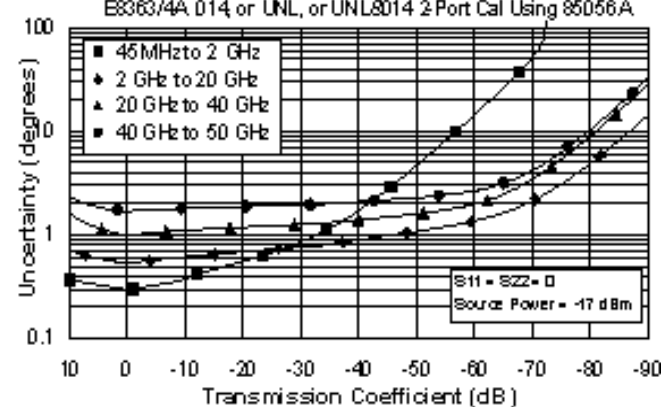

**Reflection Uncertainty (Specifications)**

**Magnitude**

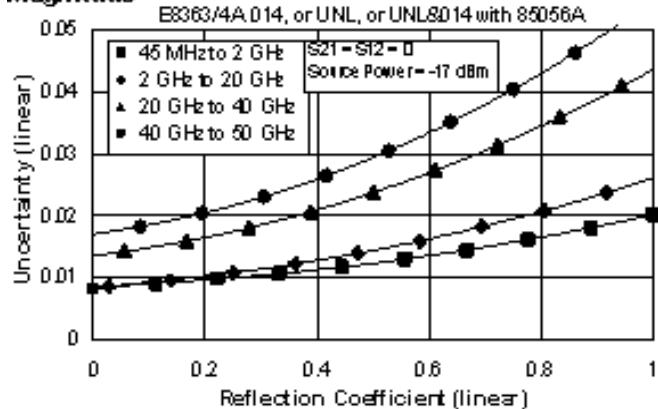

**Phase**

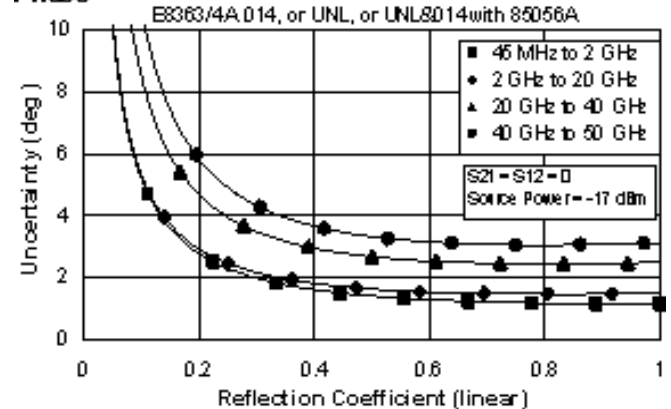

**Table 5. 85056D Calibration Kit  
Standard Configuration and Standard Power Range  
(E8363/4A)**

Applies to the, E8363/4A analyzers, 85056D (2.4mm) calibration kit, 85133F flexible test port cable set, and a full 2-port calibration. Also applies to the following condition:

Environmental temperature  $23^{\circ} \pm 3^{\circ} \text{C}$ , with  $< 1^{\circ} \text{C}$  deviation from calibration temperature

Description	Specification (dB)			
	0.045 to 2 GHz	2 to 20 GHz	20 to 40 GHz	40 to 50 GHz
Directivity	42	34	34	26
Source Match	40	30	30	23
Load Match	42	34	34	25
Reflection Tracking	$\pm 0.002$ $+0.02/^{\circ}\text{C}$	$\pm 0.029$ $+0.02/^{\circ}\text{C}$	$\pm 0.029$ $+0.03/^{\circ}\text{C}$	$\pm 0.075$ $+0.04/^{\circ}\text{C}$
Transmission Tracking	$\pm 0.016$ $+0.02/^{\circ}\text{C}$	$\pm 0.081$ $+0.02/^{\circ}\text{C}$	$\pm 0.095$ $+0.03/^{\circ}\text{C}$	$\pm 0.544$ $+0.04/^{\circ}\text{C}$

**Transmission Uncertainty (Specifications)**

**Magnitude**

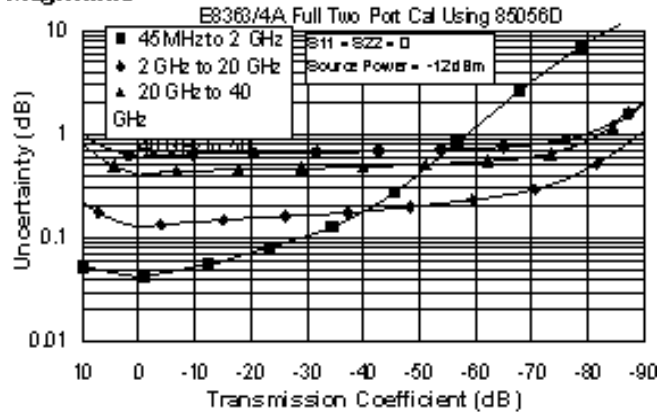

**Phase**

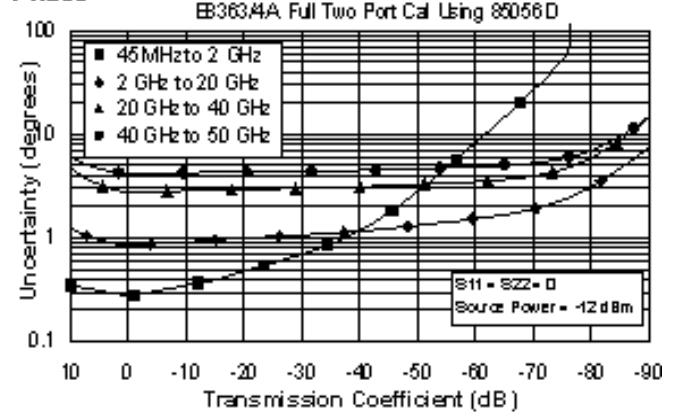

**Reflection Uncertainty (Specifications)**

**Magnitude**

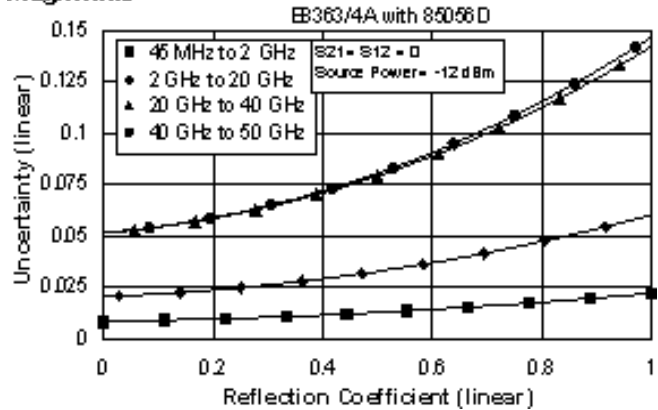

**Phase**

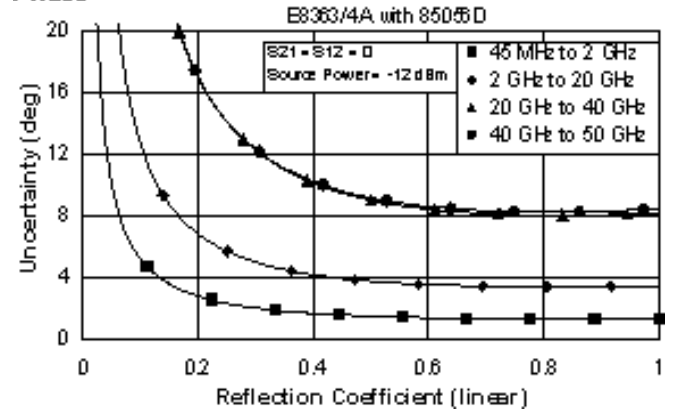



**Table 6. 85056D Calibration Kit**

**Extended Configuration and Standard Power Range (E8363/4A - Option 014)**

**-OR-**

**Standard Configuration and Extended Power Range & Bias-Tees (E8363/4A - Option UNL)**

**-OR-**

**Extended Configuration and Extended Power Range & Bias-Tees (E8363/4A - Option UNL & 014)**

Applies to the, E8363/4A analyzers, 85056D (2.4mm) calibration kit, 85133F flexible test port cable set, and a full 2-port calibration. Also applies to the following condition:

Environmental temperature 23° ±3 °C, with < 1 °C deviation from calibration temperature

Description	Specification (dB)			
	0.045 to 2 GHz	2 to 20 GHz	20 to 40 GHz	40 to 50 GHz
Directivity	42	34	26	26
Source Match	40	30	24	23
Load Match	42	33	25	25
Reflection Tracking	±0.002 +0.02/°C	±0.029 +0.02/°C	±0.079 +0.03/°C	0.075 +0.04/°C
Transmission Tracking	±0.022 +0.02/°C	±0.130 +0.02/°C	±0.384 +0.03/°C	0.589 +0.04/°C

**Transmission Uncertainty (Specifications)**

**Magnitude**

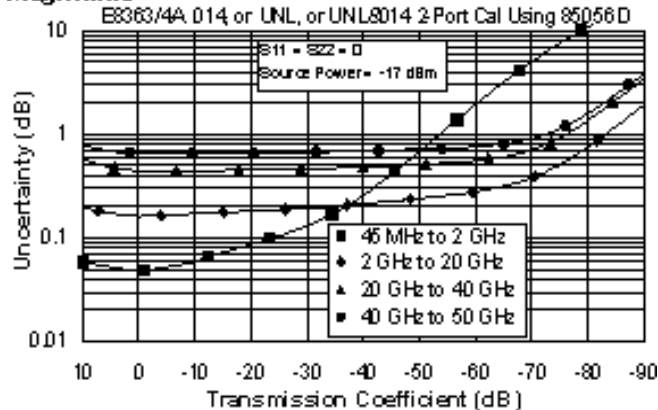

**Phase**

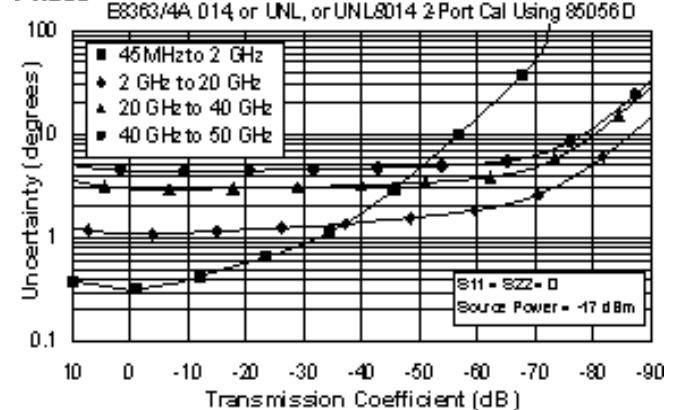

**Reflection Uncertainty (Specifications)**

**Magnitude**

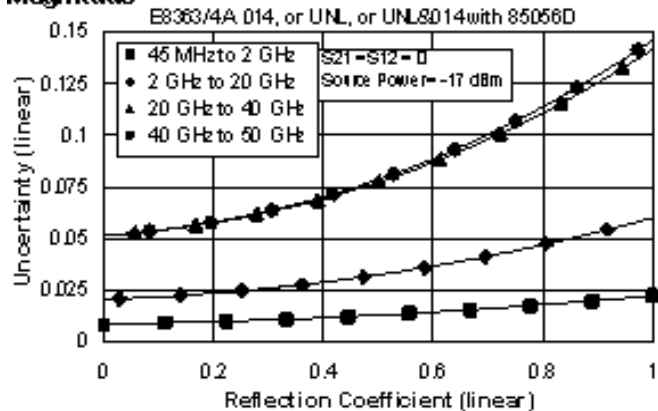

**Phase**

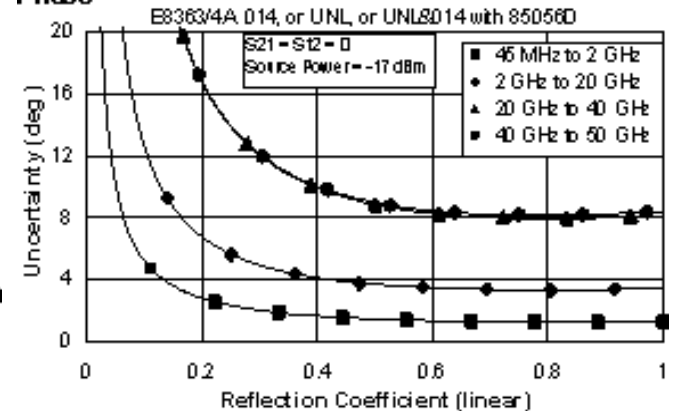

E8363/4A Corrected System Performance with 2.92mm Connectors

**Table 7. 85056K Calibration Kit  
Standard Configuration and Standard Power Range  
(E8363/4A)**

Applies to the, E8363/4A analyzers, 85056K (2.92mm) calibration kit, 85133F flexible test port cable set, and a full 2-port calibration. Also applies to the following condition:

Environmental temperature  $23^{\circ} \pm 3^{\circ} \text{C}$ , with  $< 1^{\circ} \text{C}$  deviation from calibration temperature

Description	Specification (dB)			
	0.045 to 2 GHz	2 to 10 GHz	10 to 20 GHz	20 to 40 GHz
Directivity	42	42	42	40
Source Match	40	40	40	35
Load Match	42	42	42	38
Reflection Tracking	$\pm 0.018$ $+0.02/^{\circ}\text{C}$	$\pm 0.018$ $+0.02/^{\circ}\text{C}$	$\pm 0.018$ $+0.03/^{\circ}\text{C}$	$\pm 0.067$ $+0.04/^{\circ}\text{C}$
Transmission Tracking	$\pm 0.016$ $+0.02/^{\circ}\text{C}$	$\pm 0.028$ $+0.02/^{\circ}\text{C}$	$\pm 0.033$ $+0.03/^{\circ}\text{C}$	$\pm 0.089$ $+0.04/^{\circ}\text{C}$

**Transmission Uncertainty (Specifications)**

**Magnitude**

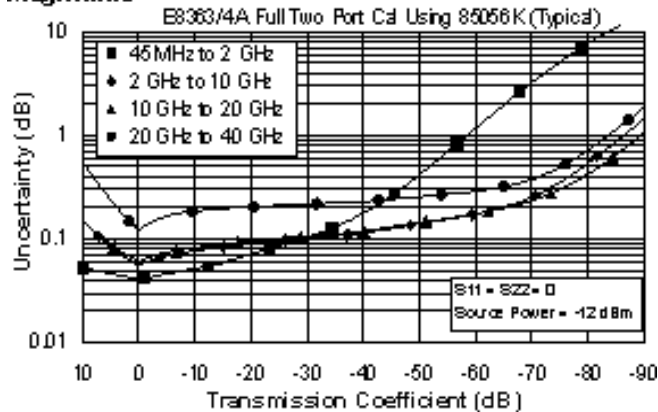

**Phase**

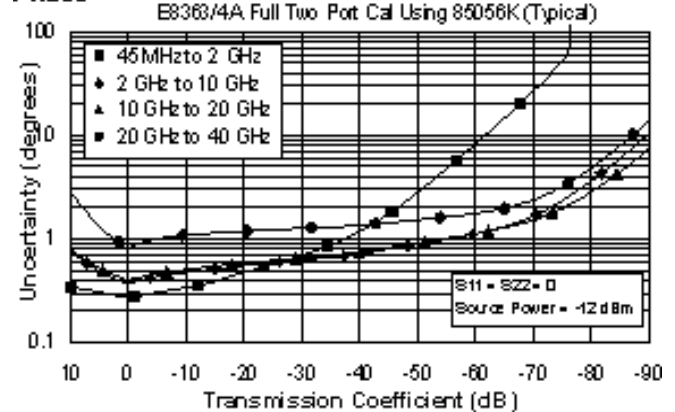

**Reflection Uncertainty (Specifications)**

**Magnitude**

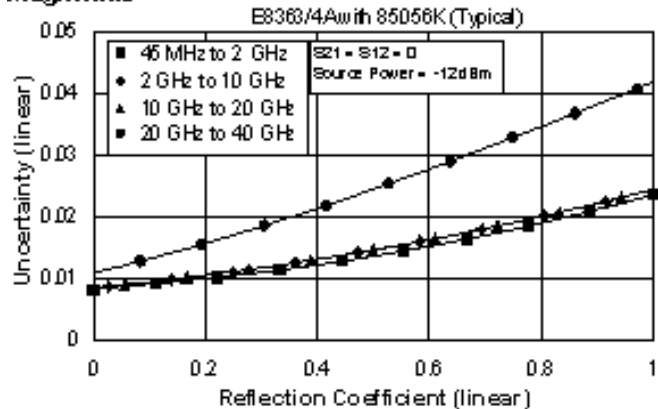

**Phase**

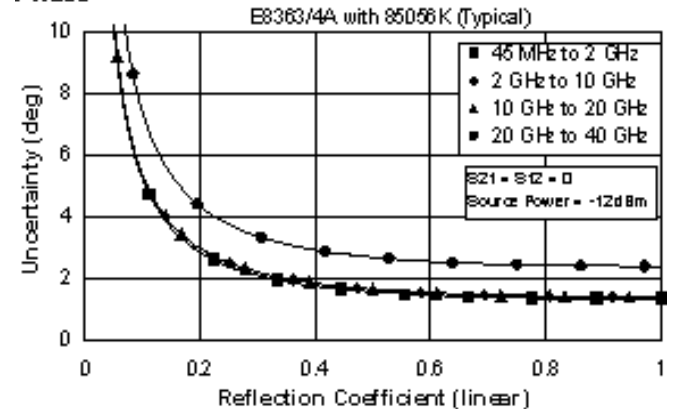

**Table 8. 85056K Calibration Kit**

**Extended Configuration and Standard Power Range (E8363/4A - Option 014)**

**-OR-**

**Standard Configuration and Extended Power Range & Bias-Tees (E8363/4A - Option UNL)**

**-OR-**

**Extended Configuration and Extended Power Range & Bias-Tees (E8363/4A - Option UNL&014)**

Applies to the, E8363/4A analyzers, 85056K (2.92mm) calibration kit, 85133F flexible test port cable set, and a full 2-port calibration. Also applies to the following condition:

Environmental temperature 23° ±3 °C, with < 1 °C deviation from calibration temperature

Description	Specification (dB)			
	0.045 to 2 GHz	2 to 10 GHz	10 to 20 GHz	20 to 40 GHz
Directivity	42	42	42	40
Source Match	40	40	40	35
Load Match	42	42	41	38
Reflection Tracking	±0.018 +0.02/°C	±0.018 +0.02/°C	±0.018 +0.03/°C	±0.067 +0.04/°C
Transmission Tracking	±0.021 +0.02/°C	±0.033 +0.02/°C	±0.046 +0.03/°C	±0.098 +0.04/°C

**Transmission Uncertainty (Specifications)**

**Magnitude**

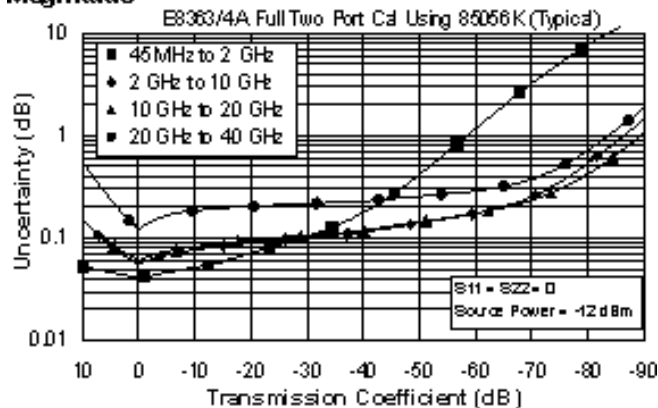

**Phase**

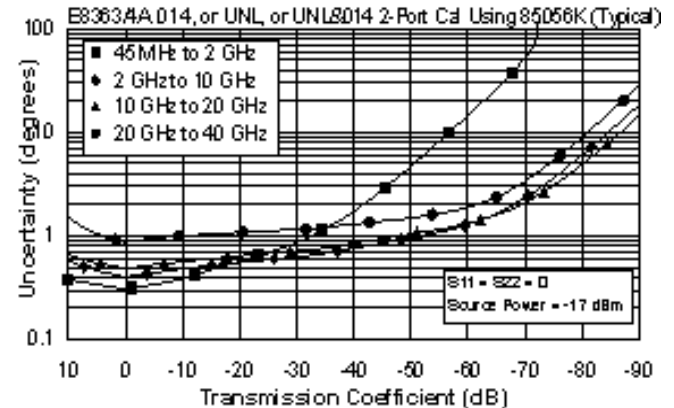

**Reflection Uncertainty (Specifications)**

**Magnitude**

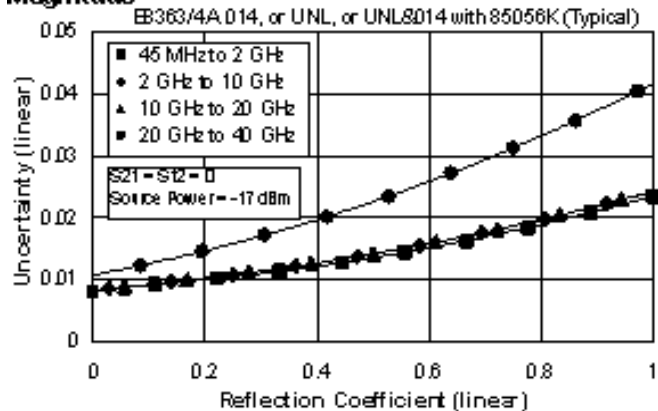

**Phase**

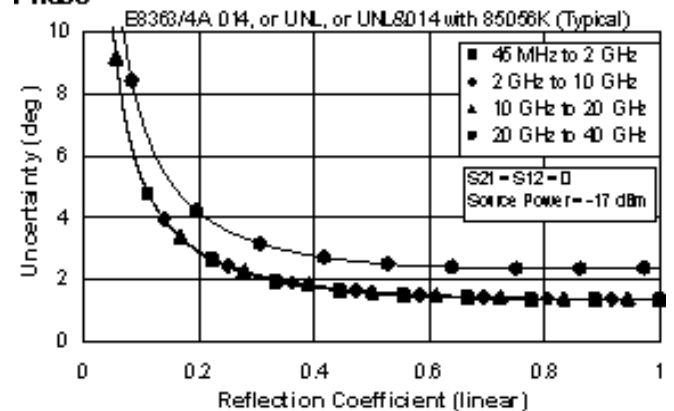

## E836xA Corrected System Performance with 3.5mm Connectors

**Table 9. 85052B Calibration Kit  
Standard Configuration and Standard Power Range  
(E836xA)**

Applies to the, E836xA analyzers, 85052B (3.5mm) calibration kit, 85131F flexible test port cable set, and a full 2-port calibration. Also applies to the following condition:

Environmental temperature  $23^{\circ} \pm 3^{\circ} \text{C}$ , with  $< 1^{\circ} \text{C}$  deviation from calibration temperature

Description	Specification (dB)			
	0.045 to 2 GHz	2 to 10 GHz	10 to 20 GHz	20 to 26.5 GHz
Directivity	48	44	44	44
Source Match	40	31	31	31
Load Match	48	44	44	44
Reflection Tracking	$\pm 0.003$ $+0.02/^{\circ}\text{C}$	$\pm 0.006$ $+0.02/^{\circ}\text{C}$	$\pm 0.006$ $+0.02/^{\circ}\text{C}$	$\pm 0.006$ $+0.03/^{\circ}\text{C}$
Transmission Tracking	$\pm 0.013$ $+0.02/^{\circ}\text{C}$	$\pm 0.057$ $+0.02/^{\circ}\text{C}$	$\pm 0.065$ $+0.02/^{\circ}\text{C}$	$\pm 0.104$ $+0.03/^{\circ}\text{C}$

### Transmission Uncertainty (Specifications)

#### Magnitude

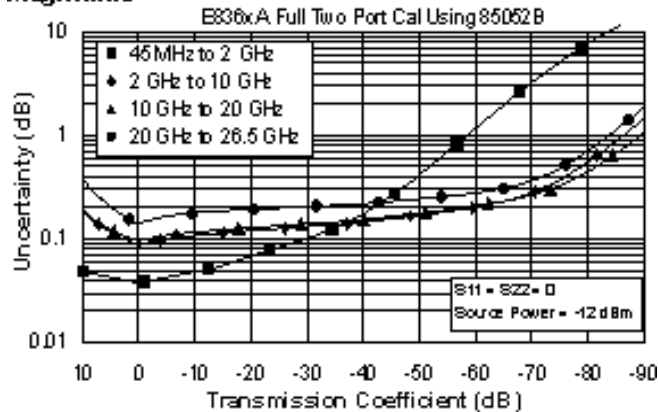

#### Phase

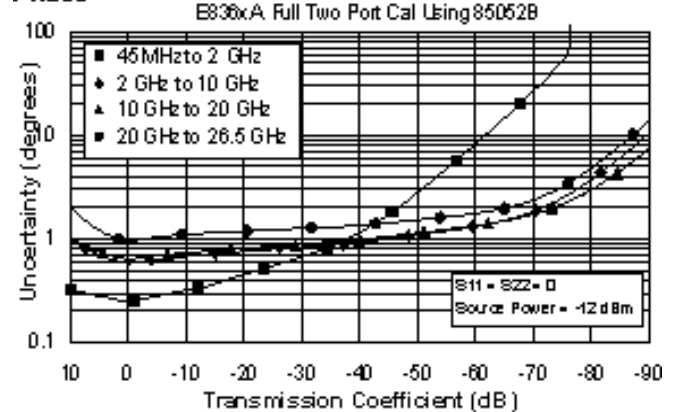

### Reflection Uncertainty (Specifications)

#### Magnitude

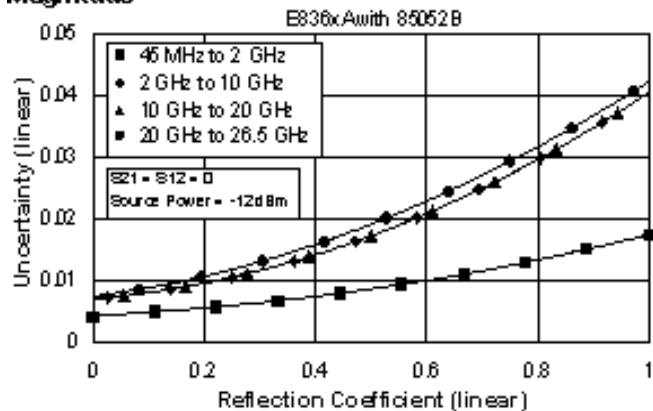

#### Phase

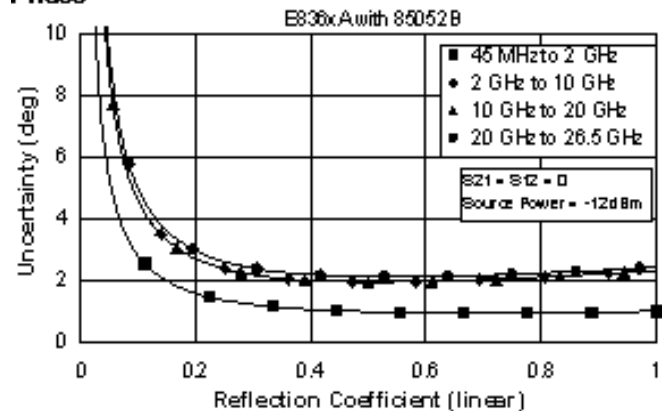

**Table 10. 85052B Calibration Kit**

**Extended Configuration and Standard Power Range (E836xA - Option 014)**

-OR-

**Standard Configuration and Extended Power Range & Bias-Tees (E836xA - Option UNL)**

-OR-

**Extended Configuration and Extended Power Range & Bias-Tees (E836xA - Option UNL&014)**

Applies to the, E836xA analyzers, 85052B (3.5mm) calibration kit, 85131F flexible test port cable set, and a full 2-port calibration. Also applies to the following condition:

Environmental temperature 23° ±3 °C, with < 1 °C deviation from calibration temperature

Description	Specification (dB)			
	0.045 to 2 GHz	2 to 10 GHz	10 to 20 GHz	20 to 26.5 GHz
Directivity	48	44	44	44
Source Match	40	31	31	31
Load Match	48	44	44	44
Reflection Tracking	±0.003 +0.02/°C	±0.006 +0.02/°C	±0.006 +0.02/°C	±0.006 +0.03/°C
Transmission Tracking	±0.017 +0.02/°C	±0.065 +0.02/°C	±0.091 +0.02/°C	±0.109 +0.03/°C

**Transmission Uncertainty (Specifications)**

**Magnitude**

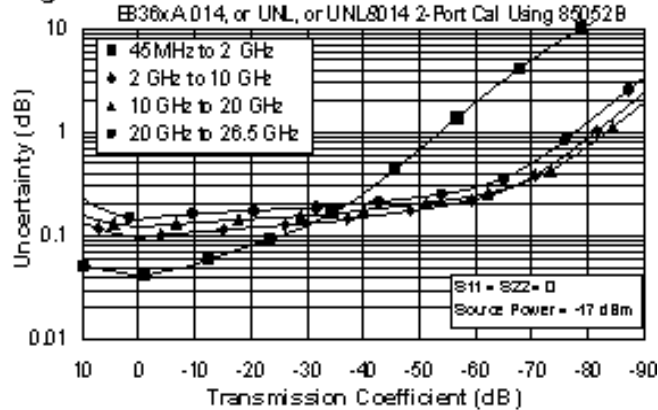

**Phase**

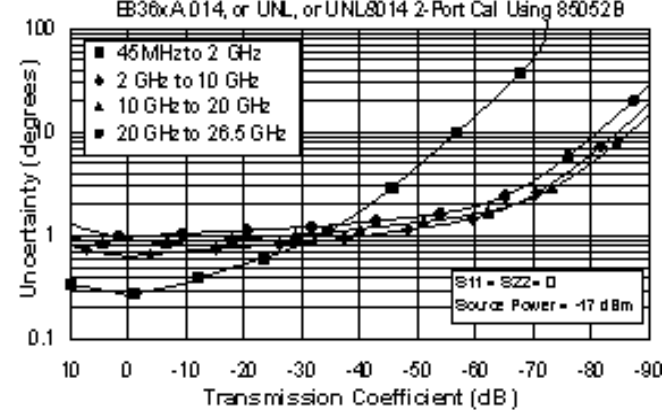

**Reflection Uncertainty (Specifications)**

**Magnitude**

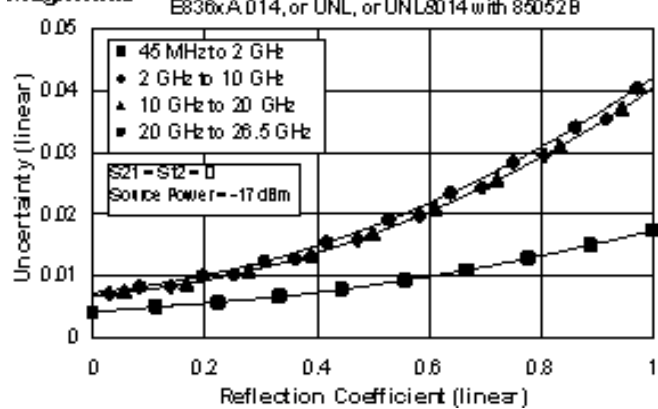

**Phase**

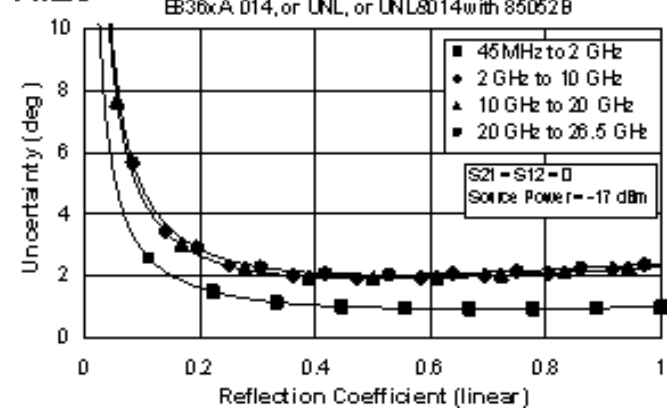

**Table 11. 85052C Calibration Kit**  
**Standard Configuration and Standard Power Range**  
**(E836xA)**

Applies to the, E836xA analyzers, 85052C (3.5mm) calibration kit, 85131F flexible test port cable set, and a full 2-port calibration. Also applies to the following condition:

Environmental temperature  $23^{\circ} \pm 3^{\circ} \text{C}$ , with  $< 1^{\circ} \text{C}$  deviation from calibration temperature

Description	Specification (dB)			
	0.045 to 2 GHz	2 to 10 GHz	10 to 20 GHz	20 to 26.5 GHz
Directivity	48	50	50	50
Source Match	40	50	50	50
Load Match	48	50	50	50
Reflection Tracking	$\pm 0.003$ $+0.02/^{\circ}\text{C}$	$\pm 0.000$ $+0.02/^{\circ}\text{C}$	$\pm 0.000$ $+0.02/^{\circ}\text{C}$	$\pm 0.000$ $+0.03/^{\circ}\text{C}$
Transmission Tracking	$\pm 0.013$ $+0.02/^{\circ}\text{C}$	$\pm 0.010$ $+0.02/^{\circ}\text{C}$	$\pm 0.012$ $+0.02/^{\circ}\text{C}$	$\pm 0.018$ $+0.03/^{\circ}\text{C}$

**Transmission Uncertainty (Specifications)**

**Magnitude**

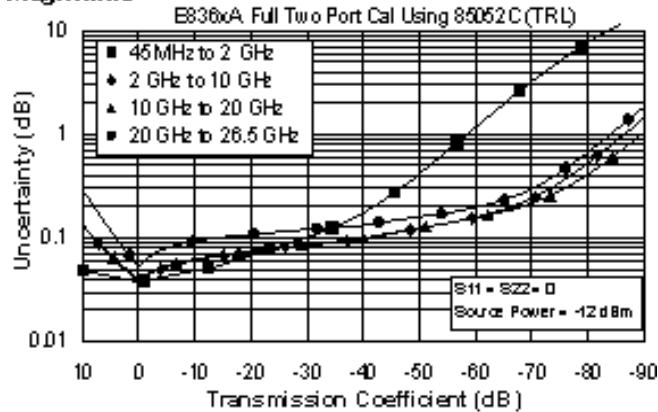

**Phase**

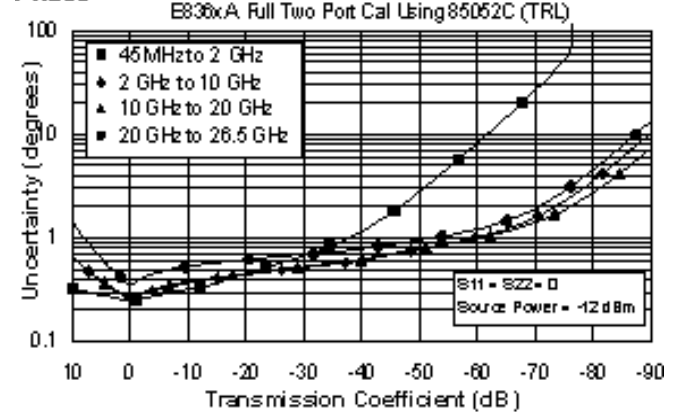

**Reflection Uncertainty (Specifications)**

**Magnitude**

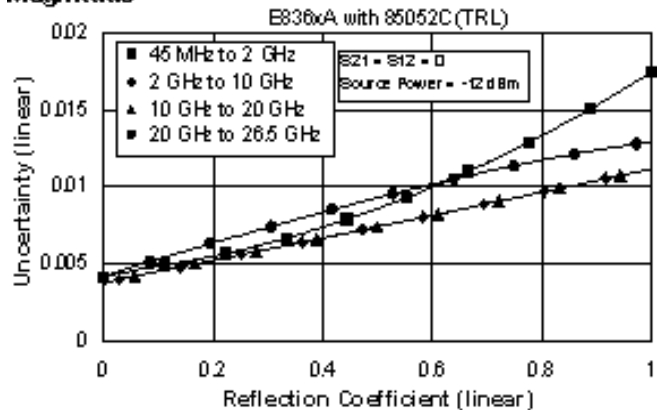

**Phase**

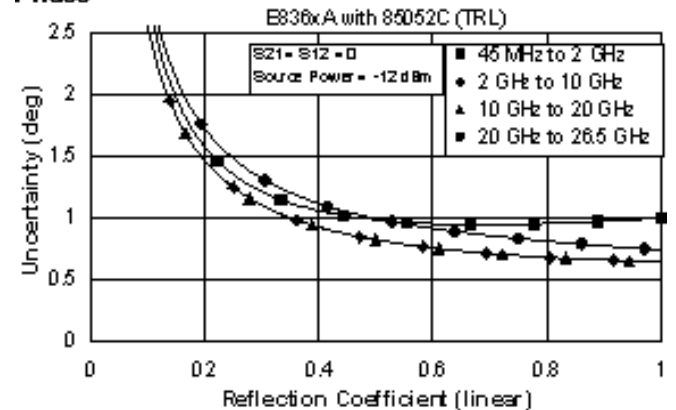

**Table 12. 85052C Calibration Kit**

**Extended Configuration and Standard Power Range (E836xA - Option 014)**

-OR-

**Standard Configuration and Extended Power Range & Bias-Tees (E836xA - Option UNL)**

-OR-

**Extended Configuration and Extended Power Range & Bias-Tees (E836xA - Option UNL&014)**

Applies to the, E836xA analyzers, 85052C (3.5mm) calibration kit, 85131F flexible test port cable set, and a full 2-port calibration. Also applies to the following condition:

Environmental temperature 23° ±3 °C, with < 1 °C deviation from calibration temperature

Description	Specification (dB)			
	0.045 to 2 GHz	2 to 10 GHz	10 to 20 GHz	20 to 26.5 GHz
Directivity	48	50	50	50
Source Match	40	50	50	50
Load Match	48	50	50	50
Reflection Tracking	±0.003 +0.02/°C	±0.000 +0.02/°C	±0.000 +0.02/°C	±0.000 +0.03/°C
Transmission Tracking	±0.017 +0.02/°C	±0.012 +0.02/°C	±0.016 +0.02/°C	±0.021 +0.03/°C

**Transmission Uncertainty (Specifications)**

**Magnitude**

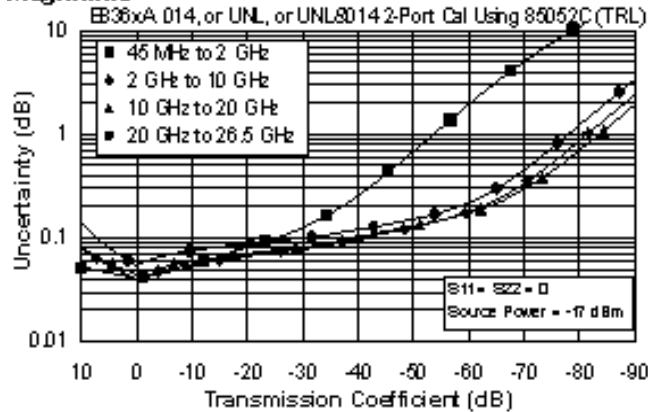

**Phase**

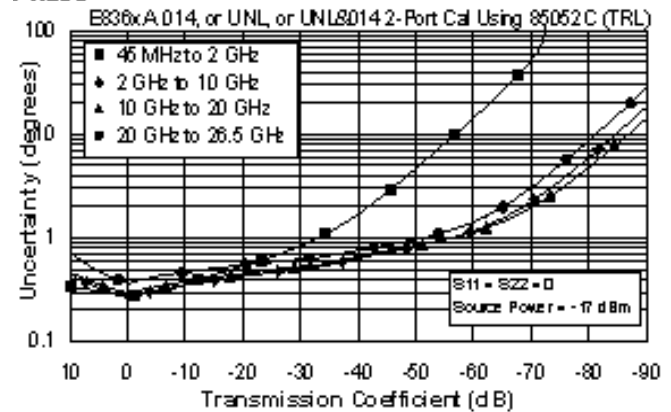

**Reflection Uncertainty (Specifications)**

**Magnitude**

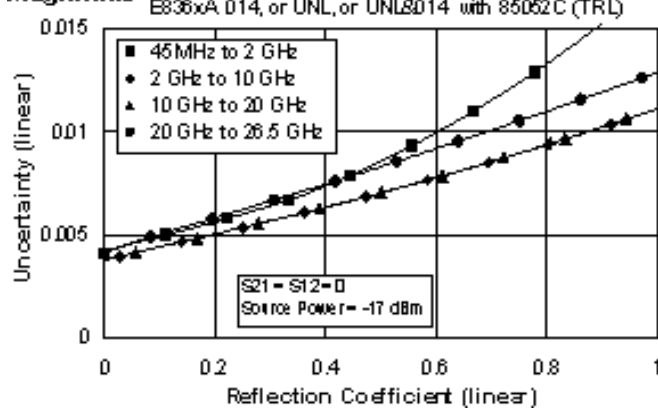

**Phase**

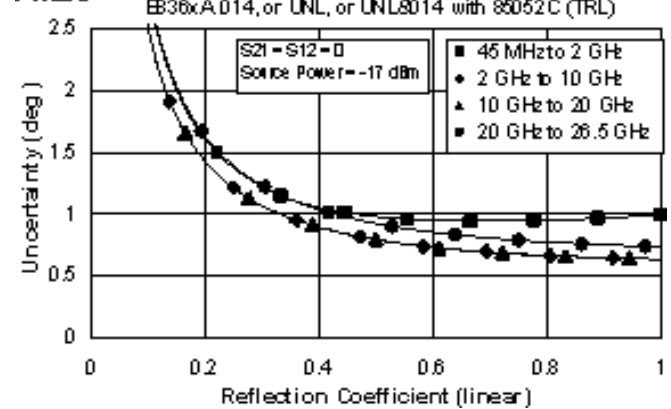

**Table 13. 85052D Calibration Kit**  
**Standard Configuration and Standard Power Range**  
**(E836xA)**

Applies to the, E836xA analyzers, 85052D (3.5mm) calibration kit, 85131F flexible test port cable set, and a full 2-port calibration. Also applies to the following condition:

Environmental temperature  $23^{\circ} \pm 3^{\circ} \text{C}$ , with  $< 1^{\circ} \text{C}$  deviation from calibration temperature

Description	Specification (dB)			
	0.045 to 2 GHz	2 to 10 GHz	10 to 20 GHz	20 to 26.5 GHz
Directivity	42	36	36	30
Source Match	37	28	28	25
Load Match	42	36	36	30
Reflection Tracking	$\pm 0.003$ $+0.02/^{\circ}\text{C}$	$\pm 0.008$ $+0.02/^{\circ}\text{C}$	$\pm 0.008$ $+0.02/^{\circ}\text{C}$	$\pm 0.011$ $+0.03/^{\circ}\text{C}$
Transmission Tracking	$\pm 0.020$ $+0.02/^{\circ}\text{C}$	$\pm 0.087$ $+0.02/^{\circ}\text{C}$	$\pm 0.101$ $+0.02/^{\circ}\text{C}$	$\pm 0.250$ $+0.03/^{\circ}\text{C}$

**Transmission Uncertainty (Specifications)**

**Magnitude**

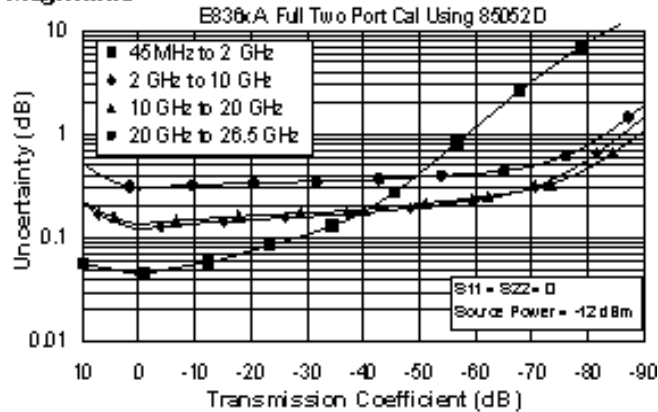

**Phase**

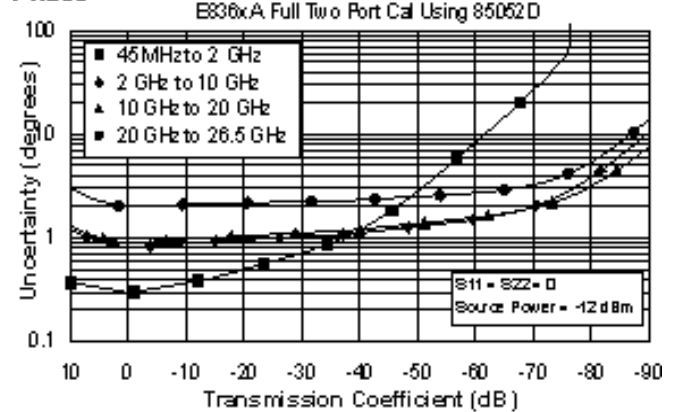

**Reflection Uncertainty (Specifications)**

**Magnitude**

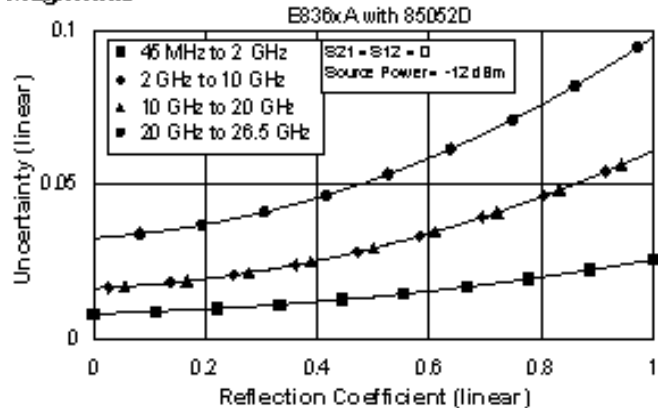

**Phase**

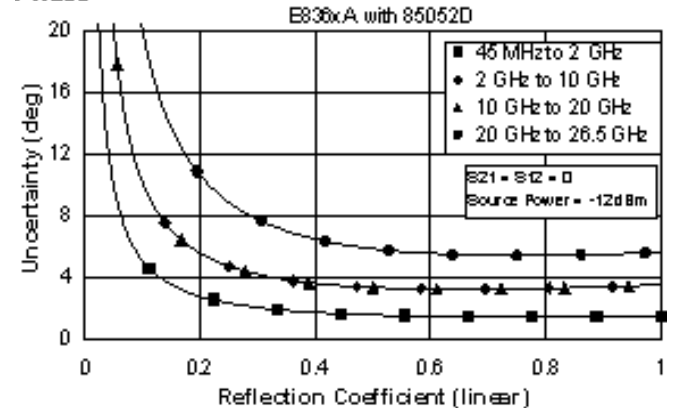



**Table 14. 85052D Calibration Kit**

**Extended Configuration and Standard Power Range (E836xA - Option 014)**

**-OR-**

**Standard Configuration and Extended Power Range & Bias-Tees (E836xA - Option UNL)**

**-OR-**

**Extended Configuration and Extended Power Range & Bias-Tees (E836xA - Option UNL&014)**

Applies to the, E836xA analyzers, 85052D (3.5mm) calibration kit, 85131F flexible test port cable set, and a full 2-port calibration. Also applies to the following condition:

Environmental temperature 23° ±3 °C, with < 1 °C deviation from calibration temperature

Description	Specification (dB)			
	0.045 to 2 GHz	2 to 10 GHz	10 to 20 GHz	20 to 26.5 GHz
Directivity	42	36	36	30
Source Match	37	28	28	25
Load Match	42	36	36	30
Reflection Tracking	±0.003 +0.02/°C	±0.008 +0.02/°C	±0.008 +0.02/°C	±0.011 +0.03/°C
Transmission Tracking	±0.026 +0.02/°C	±0.101 +0.02/°C	±0.138 +0.02/°C	±0.272 +0.03/°C

**Transmission Uncertainty (Specifications)**

**Magnitude**

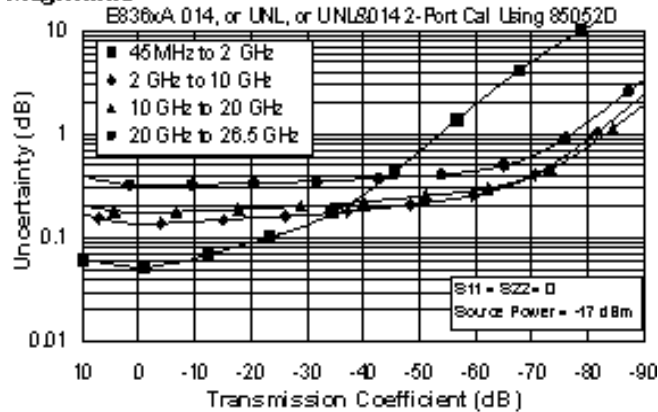

**Phase**

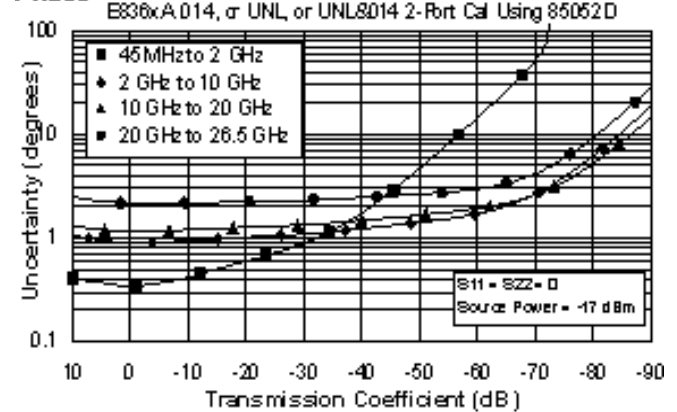

**Reflection Uncertainty (Specifications)**

**Magnitude**

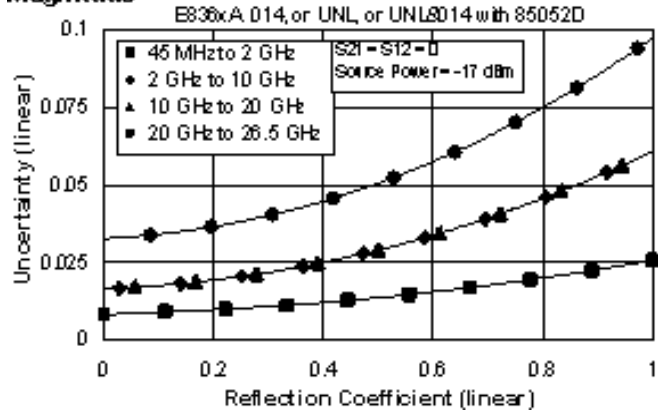

**Phase**

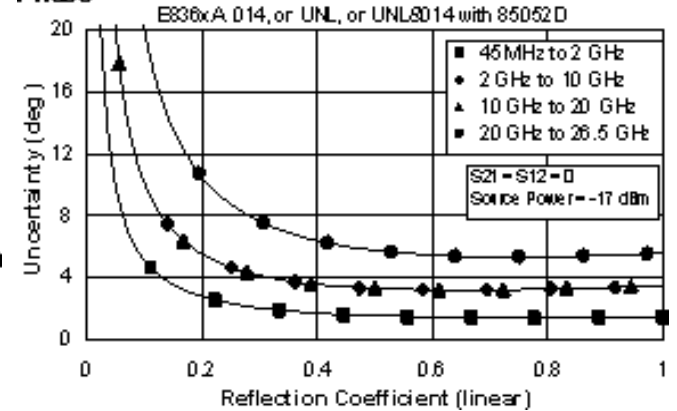

## E836xA Corrected System Performance with 7mm Connectors

**Table 15. 85050B Calibration Kit  
Standard Configuration and Standard Power Range  
(E836xA)**

Applies to the, E836xA analyzers, 85050B (7mm) calibration kit, 85132F flexible test port cable set, and a full 2-port calibration. Also applies to the following condition:

Environmental temperature  $23^{\circ} \pm 3^{\circ} \text{C}$ , with  $< 1^{\circ} \text{C}$  deviation from calibration temperature

Description	Specification (dB)		
	0.045 to 2 GHz	2 to 10 GHz	10 to 18 GHz
Directivity	52	52	52
Source Match	48	41	41
Load Match	52	52	52
Reflection Tracking	$\pm 0.003$ $+0.02/^{\circ}\text{C}$	$\pm 0.047$ $+0.02/^{\circ}\text{C}$	$\pm 0.047$ $+0.02/^{\circ}\text{C}$
Transmission Tracking	$\pm 0.006$ $+0.02/^{\circ}\text{C}$	$\pm 0.019$ $+0.02/^{\circ}\text{C}$	$\pm 0.022$ $+0.02/^{\circ}\text{C}$

### Transmission Uncertainty (Specifications)

#### Magnitude

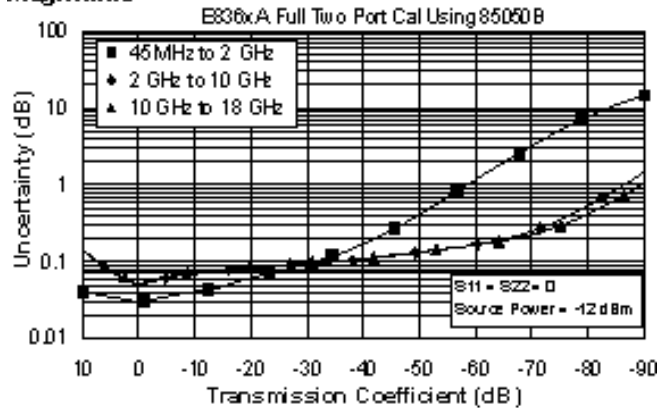

#### Phase

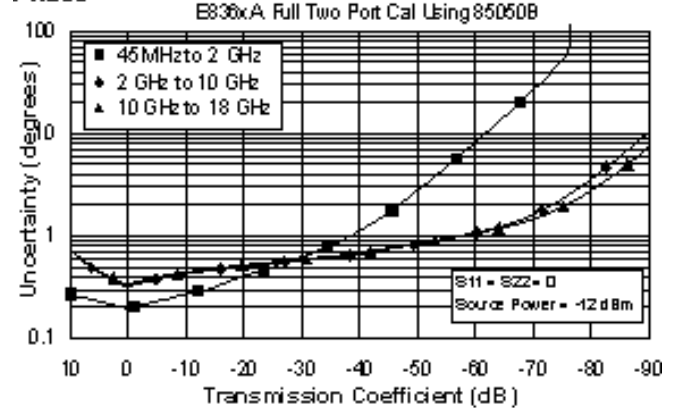

### Reflection Uncertainty (Specifications)

#### Magnitude

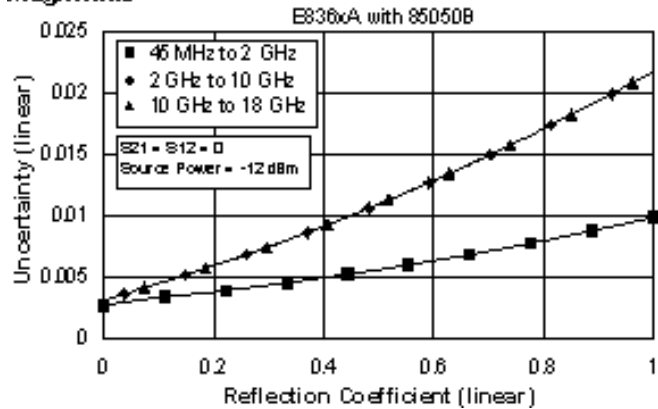

#### Phase

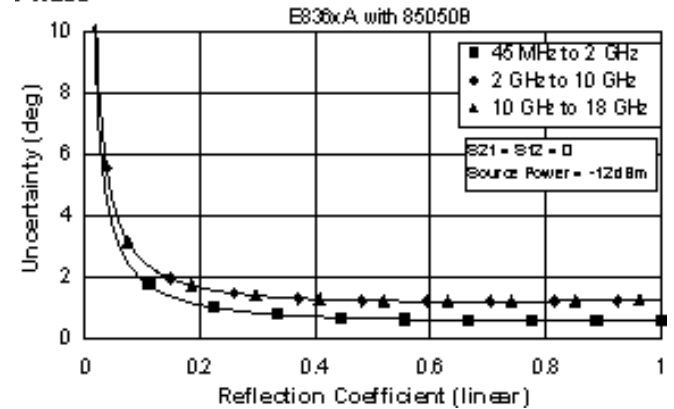

**Table 16. 85050B Calibration Kit**

**Extended Configuration and Standard Power Range (E836xA - Option 014)**

**-OR-**

**Standard Configuration and Extended Power Range & Bias-Tees (E836xA - Option UNL)**

**-OR-**

**Extended Configuration and Extended Power Range & Bias-Tees (E836xA - Option UNL&014)**

Applies to the, E836xA analyzers, 85050B (7mm) calibration kit, 85132F flexible test port cable set, and a full 2-port calibration. Also applies to the following condition:

Environmental temperature 23° ±3 °C, with < 1 °C deviation from calibration temperature

Description	Specification (dB)		
	0.045 to 2 GHz	2 to 10 GHz	10 to 18 GHz
Directivity	52	52	52
Source Match	48	41	41
Load Match	52	52	47
Reflection Tracking	±0.003 +0.02/°C	±0.047 +0.02/°C	±0.047 +0.02/°C
Transmission Tracking	±0.008 +0.02/°C	±0.022 +0.02/°C	±0.034 +0.02/°C

**Transmission Uncertainty (Specifications)**

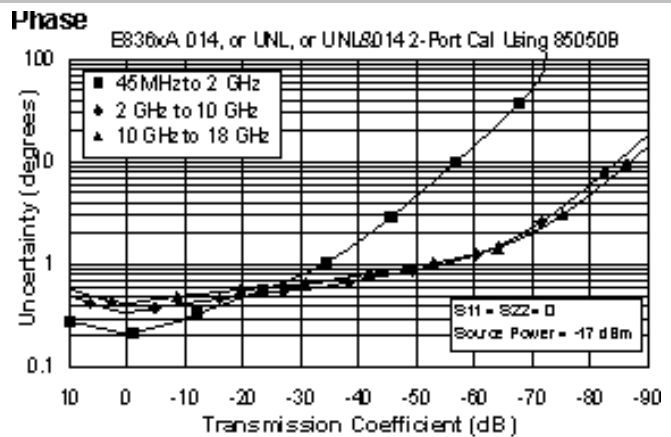
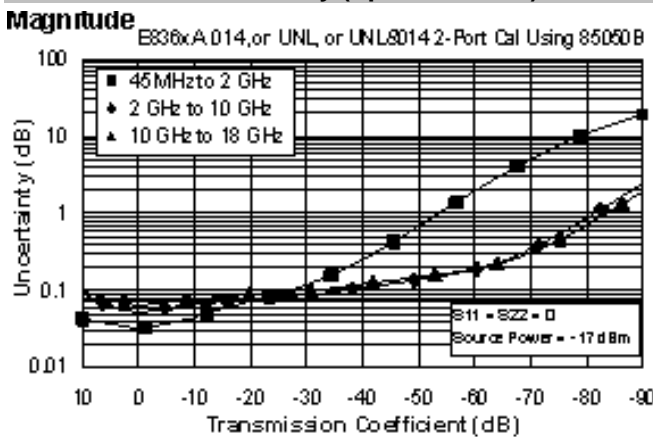

**Reflection Uncertainty (Specifications)**

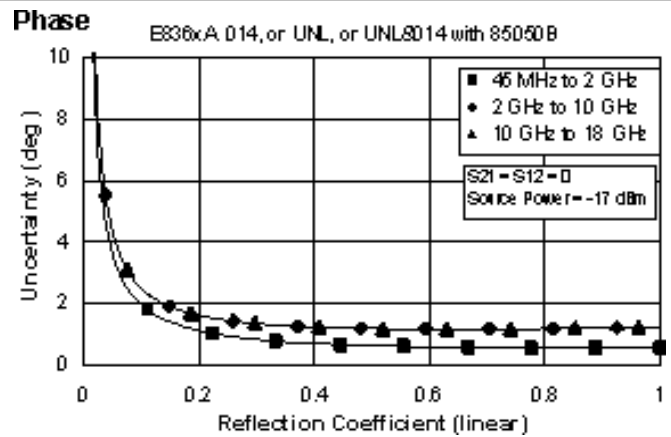
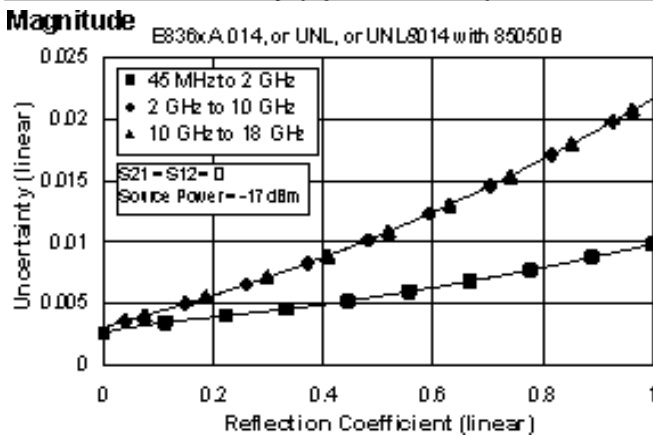

**Table 17. 85050C Calibration Kit**  
**Standard Configuration and Standard Power Range**  
**(E836xA)**

Applies to the, E836xA analyzers, 85050C (7mm) calibration kit, 85132F flexible test port cable set, and a full 2-port calibration. Also applies to the following condition:

Environmental temperature  $23^{\circ} \pm 3^{\circ} \text{C}$ , with  $< 1^{\circ} \text{C}$  deviation from calibration temperature

Description	Specification (dB)		
	0.045 to 2 GHz	2 to 10 GHz	10 to 18 GHz
Directivity	52	60	60
Source Match	48	60	60
Load Match	52	60	60
Reflection Tracking	$\pm 0.003$ $+0.02/^{\circ}\text{C}$	$\pm 0.000$ $+0.02/^{\circ}\text{C}$	$\pm 0.000$ $+0.02/^{\circ}\text{C}$
Transmission Tracking	$\pm 0.006$ $+0.02/^{\circ}\text{C}$	$\pm 0.003$ $+0.02/^{\circ}\text{C}$	$\pm 0.004$ $+0.02/^{\circ}\text{C}$

**Transmission Uncertainty (Specifications)**

**Magnitude**

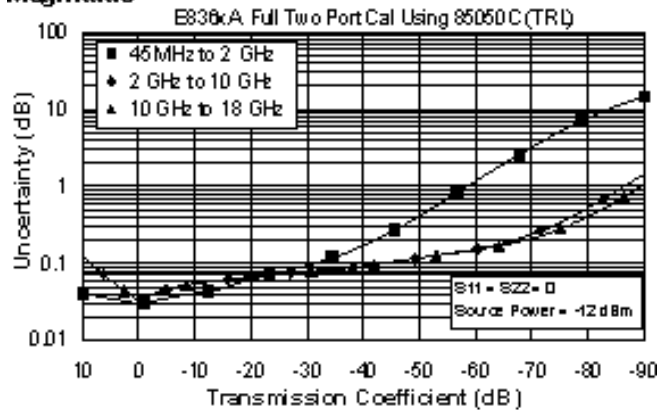

**Phase**

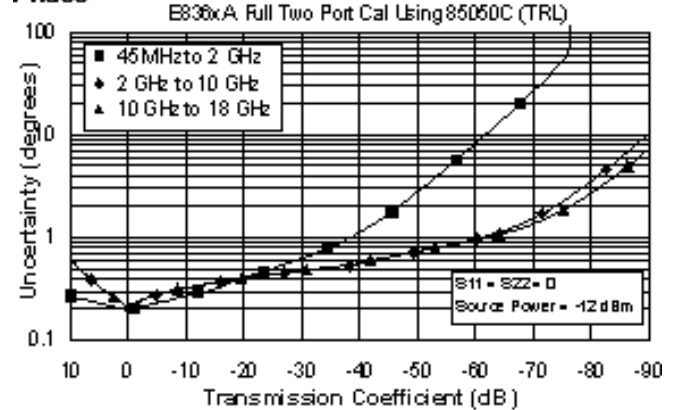

**Reflection Uncertainty (Specifications)**

**Magnitude**

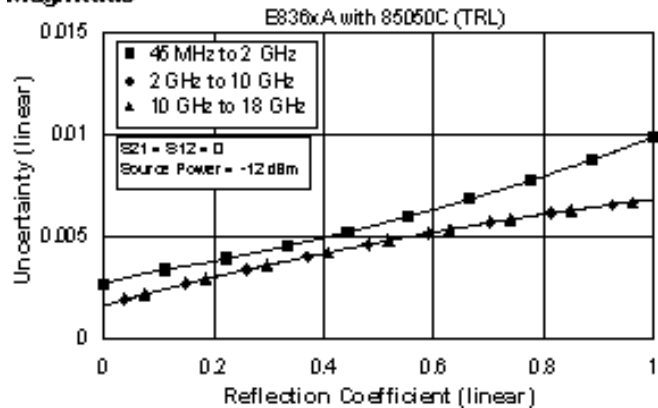

**Phase**

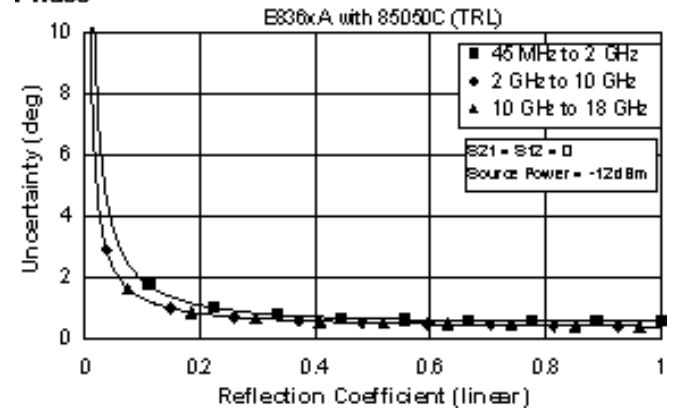

**Table 18. 85050C Calibration Kit**

**Extended Configuration and Standard Power Range (E836xA - Option 014)**

**-OR-**

**Standard Configuration and Extended Power Range & Bias-Tees (E836xA - Option UNL)**

**-OR-**

**Extended Configuration and Extended Power Range & Bias-Tees (E836xA - Option UNL&014)**

Applies to the, E836xA analyzers, 85050C (7mm) calibration kit, 85132F flexible test port cable set, and a full 2-port calibration. Also applies to the following condition:

Environmental temperature 23° ±3 °C, with < 1 °C deviation from calibration temperature

Description	Specification (dB)		
	0.045 to 2 GHz	2 to 10 GHz	10 to 18 GHz
Directivity	52	60	60
Source Match	48	60	60
Load Match	52	60	60
Reflection Tracking	±0.003 +0.02/°C	±0.000 +0.02/°C	±0.000 +0.02/°C
Transmission Tracking	±0.008 +0.02/°C	±0.004 +0.02/°C	±0.005 +0.02/°C

**Transmission Uncertainty (Specifications)**

**Magnitude**

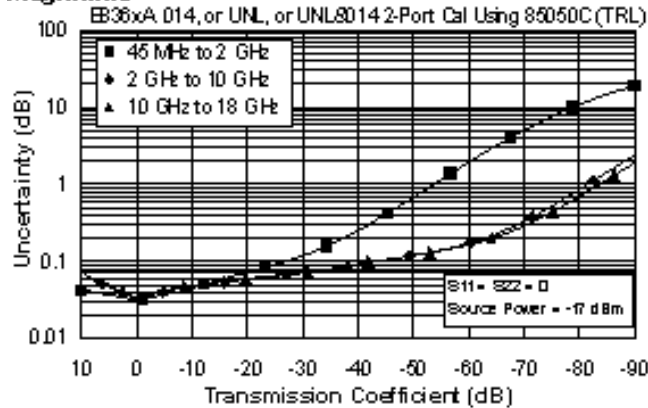

**Phase**

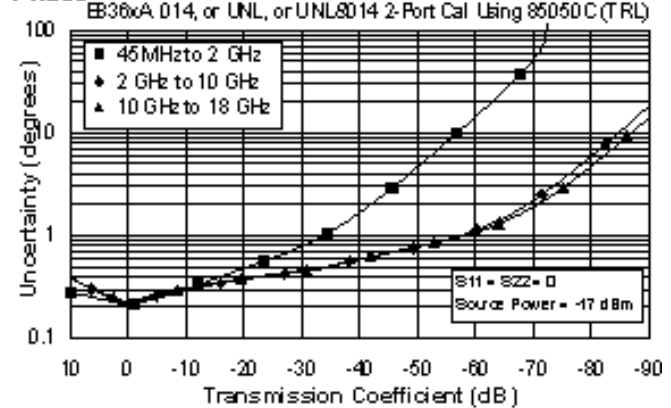

**Reflection Uncertainty (Specifications)**

**Magnitude**

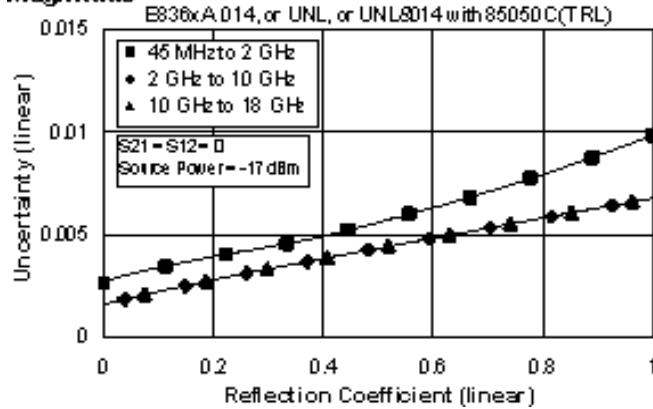

**Phase**

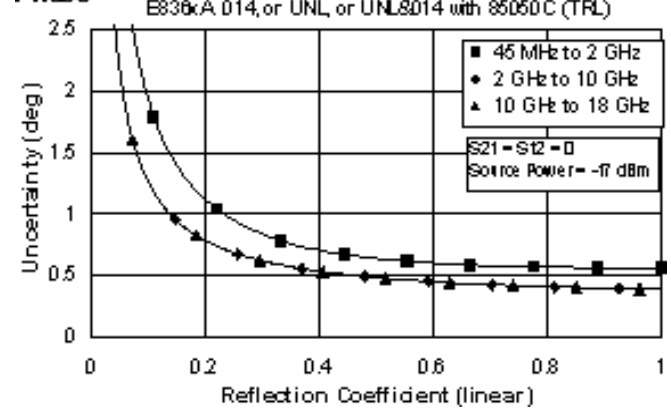

**Table 19. 85050D Calibration Kit**  
**Standard Configuration and Standard Power Range**  
**(E836xA)**

Applies to the, E836xA analyzers, 85050D (7mm) calibration kit, 85132F flexible test port cable set, and a full 2-port calibration. Also applies to the following condition:

Environmental temperature  $23^{\circ} \pm 3^{\circ} \text{C}$ , with  $< 1^{\circ} \text{C}$  deviation from calibration temperature

Description	Specification (dB)		
	0.045 to 2 GHz	2 to 10 GHz	10 to 18 GHz
Directivity	40	40	40
Source Match	39	35	35
Load Match	40	40	40
Reflection Tracking	$\pm 0.010$ $+0.02/^{\circ}\text{C}$	$\pm 0.100$ $+0.02/^{\circ}\text{C}$	$\pm 0.100$ $+0.02/^{\circ}\text{C}$
Transmission Tracking	$\pm 0.018$ $+0.02/^{\circ}\text{C}$	$\pm 0.044$ $+0.02/^{\circ}\text{C}$	$\pm 0.052$ $+0.02/^{\circ}\text{C}$

**Transmission Uncertainty (Specifications)**

**Magnitude**

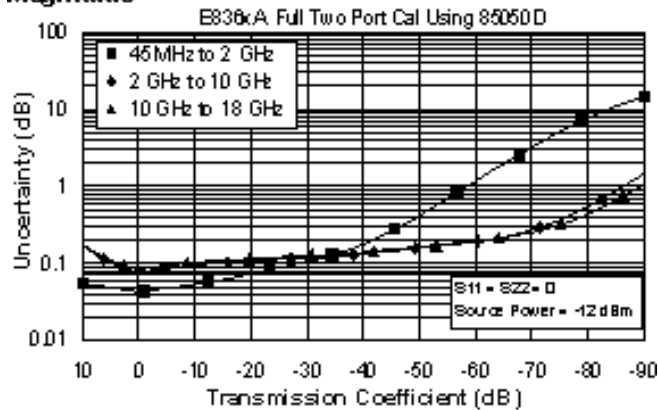

**Phase**

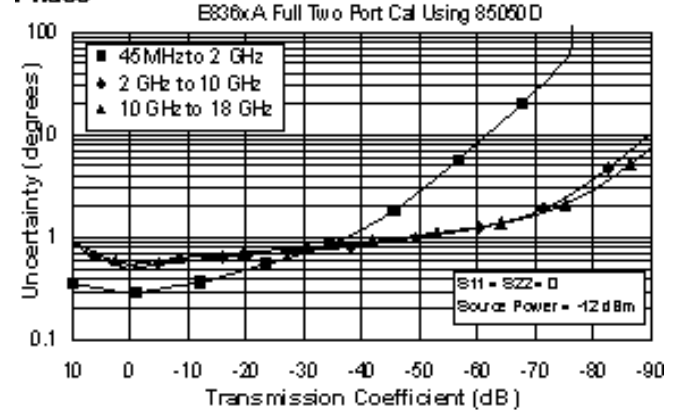

**Reflection Uncertainty (Specifications)**

**Magnitude**

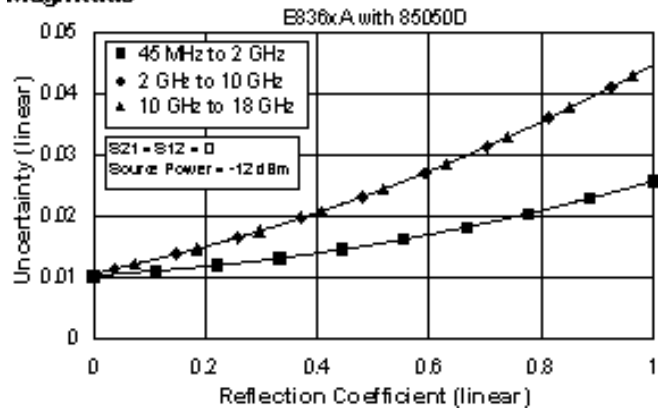

**Phase**

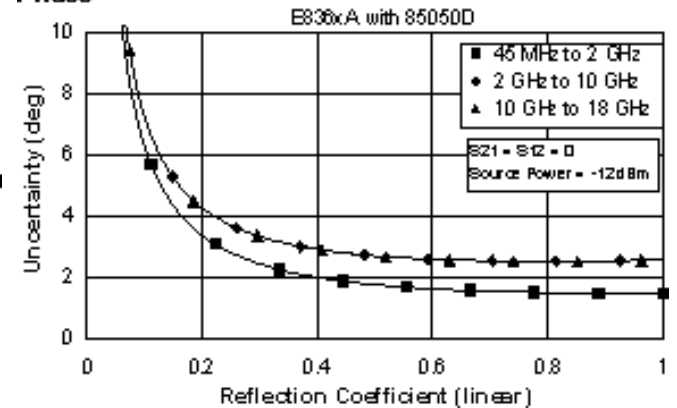

**Table 20. 85050D Calibration Kit**

**Extended Configuration and Standard Power Range (E836xA - Option 014)**

**-OR-**

**Standard Configuration and Extended Power Range & Bias-Tees (E836xA - Option UNL)**

**-OR-**

**Extended Configuration and Extended Power Range & Bias-Tees (E836xA - Option UNL&014)**

Applies to the, E836xA analyzers, 85050D (7mm) calibration kit, 85132F flexible test port cable set, and a full 2-port calibration. Also applies to the following condition:

Environmental temperature 23° ±3 °C, with < 1 °C deviation from calibration temperature

Description	Specification (dB)		
	0.045 to 2 GHz	2 to 10 GHz	10 to 18 GHz
Directivity	40	40	40
Source Match	39	35	35
Load Match	40	40	37
Reflection Tracking	±0.010 +0.02/°C	±0.100 +0.02/°C	±0.100 +0.02/°C
Transmission Tracking	±0.025 +0.02/°C	±0.052 +0.02/°C	±0.078 +0.02/°C

**Transmission Uncertainty (Specifications)**

**Magnitude**

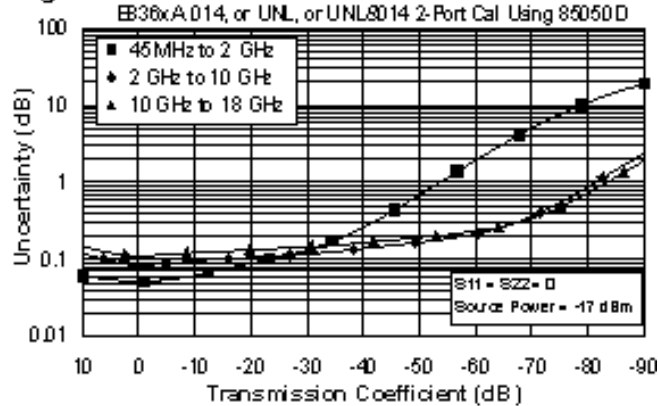

**Phase**

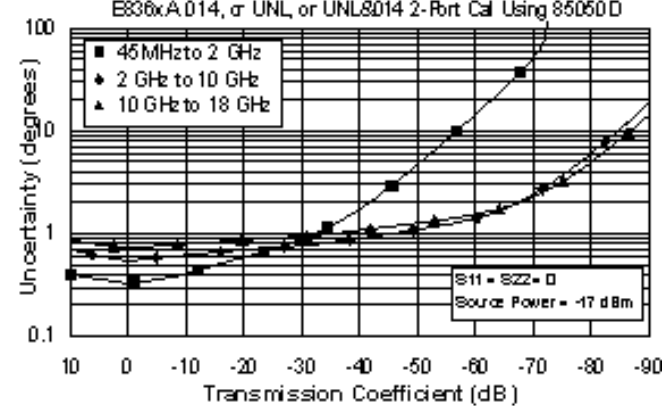

**Reflection Uncertainty (Specifications)**

**Magnitude**

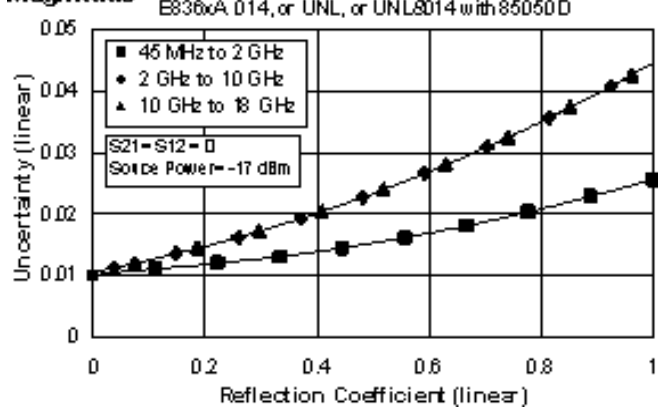

**Phase**

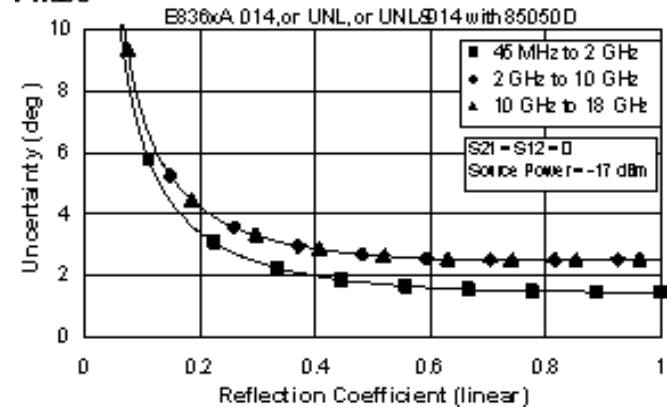

## E836xA Corrected System Performance with Type-N Connectors

**Table 21. 85054B Calibration Kit  
Standard Configuration and Standard Power Range  
(E836xA)**

Applies to the, E836xA analyzers, 85054B (Type-N) calibration kit, 85132F flexible test port cable set with 85130C adapter set, and a full 2-port calibration. Also applies to the following condition:

Environmental temperature  $23^{\circ} \pm 3^{\circ} \text{C}$ , with  $< 1^{\circ} \text{C}$  deviation from calibration temperature

Description	Specification (dB)		
	0.045 to 2 GHz	2 to 10 GHz	10 to 18 GHz
Directivity	48	42	42
Source Match	45	33	33
Load Match	48	42	42
Reflection Tracking	$\pm 0.007$ $+0.02/^{\circ}\text{C}$	$\pm 0.096$ $+0.02/^{\circ}\text{C}$	$\pm 0.096$ $+0.02/^{\circ}\text{C}$
Transmission Tracking	$\pm 0.009$ $+0.02/^{\circ}\text{C}$	$\pm 0.052$ $+0.02/^{\circ}\text{C}$	$\pm 0.060$ $+0.02/^{\circ}\text{C}$

### Transmission Uncertainty (Specifications)

#### Magnitude

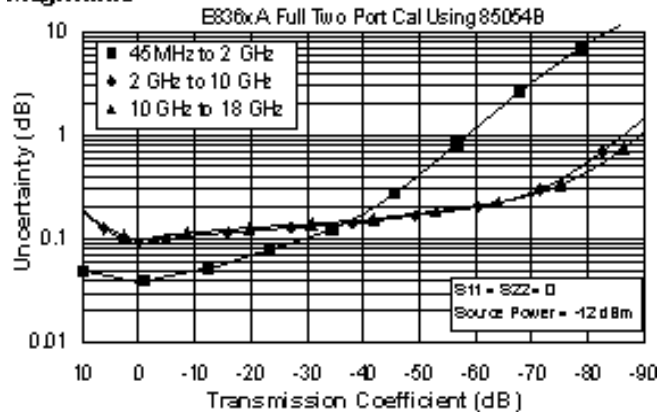

#### Phase

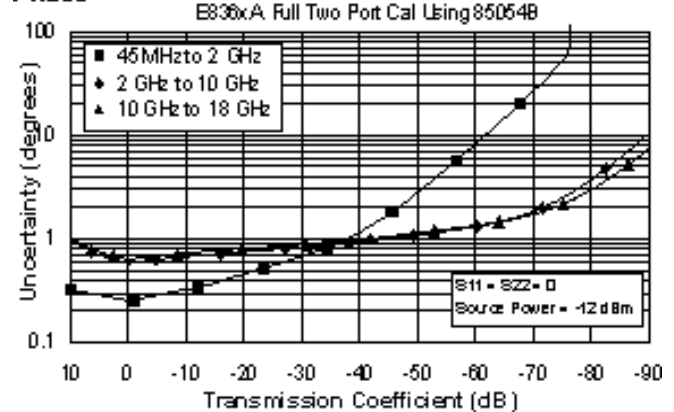

### Reflection Uncertainty (Specifications)

#### Magnitude

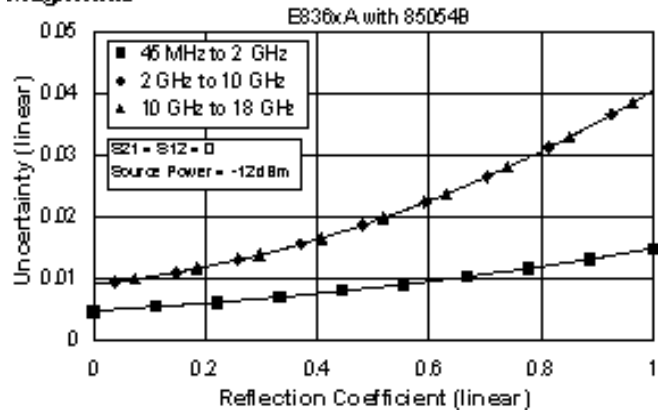

#### Phase

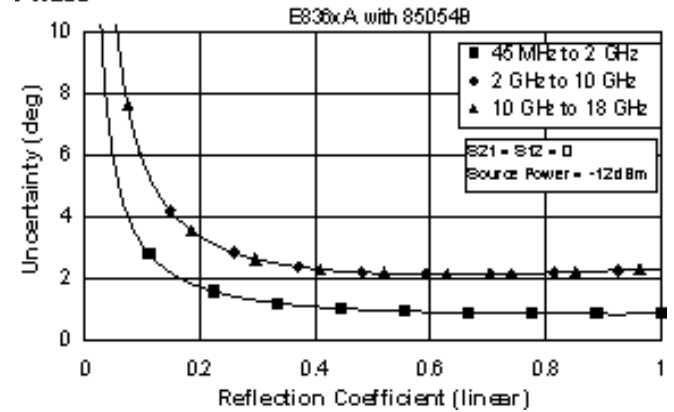



**Table 22. 85054B Calibration Kit**

**Extended Configuration and Standard Power Range (E836xA - Option 014)**

**-OR-**

**Standard Configuration and Extended Power Range & Bias-Tees (E836xA - Option UNL)**

**-OR-**

**Extended Configuration and Extended Power Range & Bias-Tees (E836xA - Option UNL&014)**

Applies to the, E836xA analyzers, 85054B (Type-N) calibration kit, 85132F flexible test port cable set with 85130C adapter set, and a full 2-port calibration. Also applies to the following condition:

Environmental temperature 23° ±3 °C, with < 1 °C deviation from calibration temperature

Description	Specification (dB)		
	0.045 to 2 GHz	2 to 10 GHz	10 to 18 GHz
Directivity	48	42	42
Source Match	45	33	33
Load Match	48	42	41
Reflection Tracking	±0.007 +0.02/°C	±0.096 +0.02/°C	±0.096 +0.02/°C
Transmission Tracking	±0.011 +0.02/°C	±0.060 +0.02/°C	±0.083 +0.02/°C

**Transmission Uncertainty (Specifications)**

**Magnitude**

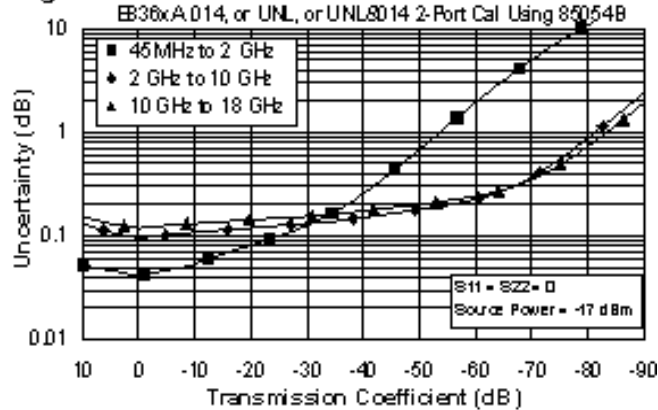

**Phase**

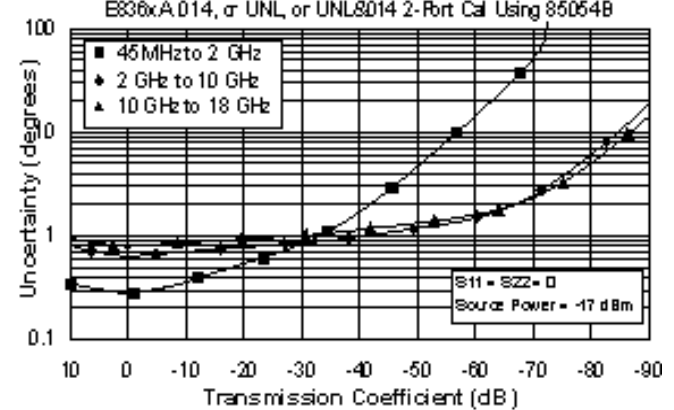

**Reflection Uncertainty (Specifications)**

**Magnitude**

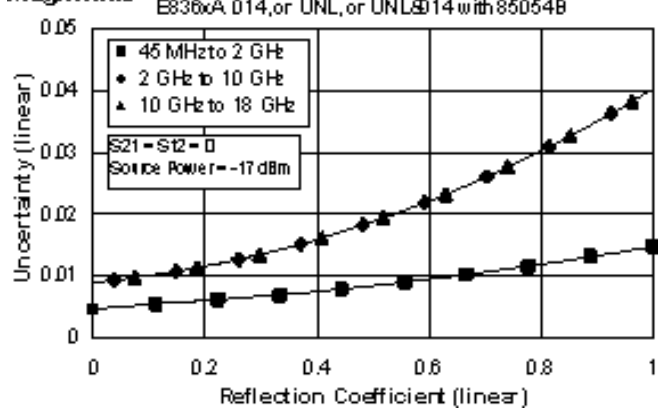

**Phase**

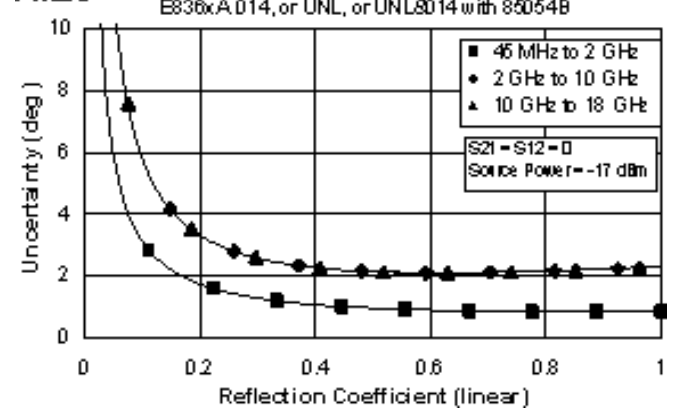

**Table 23. 85054D Calibration Kit  
Standard Configuration and Standard Power Range  
(E836xA)**

Applies to the, E836xA analyzers, 85054D (Type-N) calibration kit, 85132F flexible test port cable set with 85130C adapter set, and a full 2-port calibration. Also applies to the following condition:

Environmental temperature  $23^{\circ} \pm 3^{\circ} \text{C}$ , with  $< 1^{\circ} \text{C}$  deviation from calibration temperature

Description	Specification (dB)		
	0.045 to 2 GHz	2 to 10 GHz	10 to 18 GHz
Directivity	40	34	34
Source Match	39	29	29
Load Match	40	34	34
Reflection Tracking	$\pm 0.003$ $+0.02/^{\circ}\text{C}$	$\pm 0.027$ $+0.02/^{\circ}\text{C}$	$\pm 0.027$ $+0.02/^{\circ}\text{C}$
Transmission Tracking	$\pm 0.019$ $+0.02/^{\circ}\text{C}$	$\pm 0.091$ $+0.02/^{\circ}\text{C}$	$\pm 0.105$ $+0.02/^{\circ}\text{C}$

**Transmission Uncertainty (Specifications)**

**Magnitude**

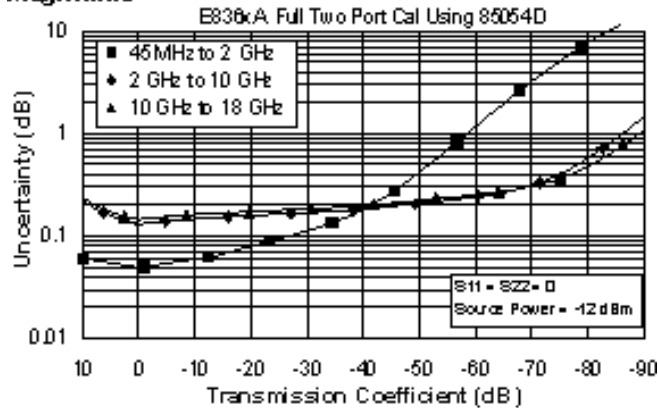

**Phase**

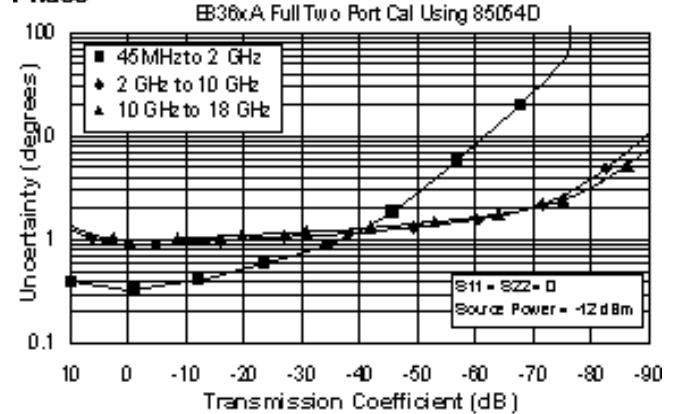

**Reflection Uncertainty (Specifications)**

**Magnitude**

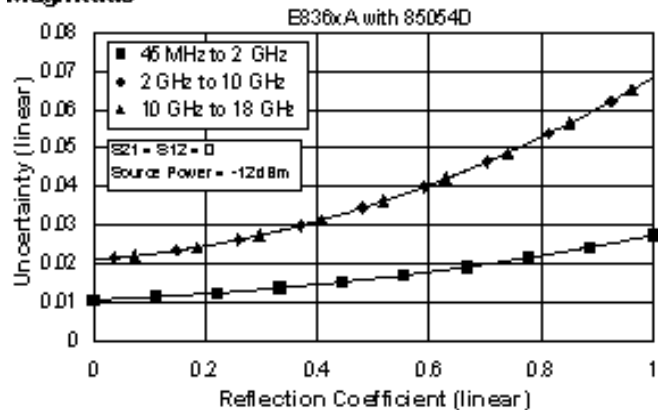

**Phase**

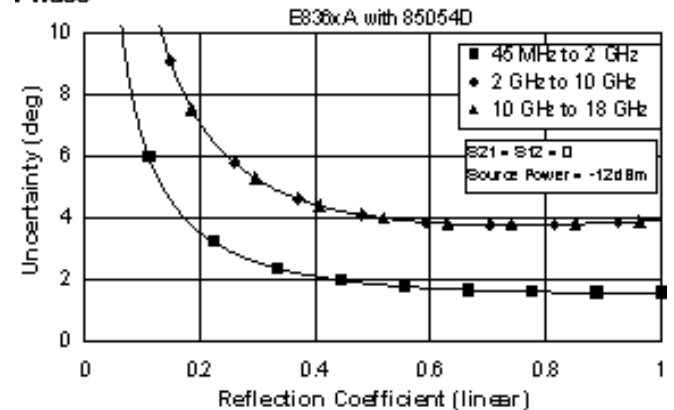

**Table 24. 85054D Calibration Kit**

**Extended Configuration and Standard Power Range (E836xA - Option 014)**

-OR-

**Standard Configuration and Extended Power Range & Bias-Tees (E836xA - Option UNL)**

-OR-

**Extended Configuration and Extended Power Range & Bias-Tees (E836xA - Option UNL&014)**

Applies to the, E836xA analyzers, 85054D (Type-N) calibration kit, 85132F flexible test port cable set with 85130C adapter set, and a full 2-port calibration. Also applies to the following condition:

Environmental temperature 23° ±3 °C, with < 1 °C deviation from calibration temperature

Description	Specification (dB)		
	0.045 to 2 GHz	2 to 10 GHz	10 to 18 GHz
Directivity	40	34	34
Source Match	39	29	29
Load Match	40	34	34
Reflection Tracking	±0.003 +0.02/°C	±0.027 +0.02/°C	±0.027 +0.02/°C
Transmission Tracking	±0.025 +0.02/°C	±0.105 +0.02/°C	±0.145 +0.02/°C

**Transmission Uncertainty (Specifications)**

**Magnitude**

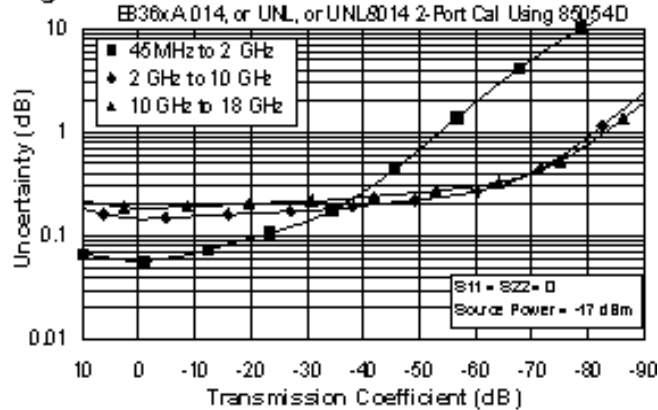

**Phase**

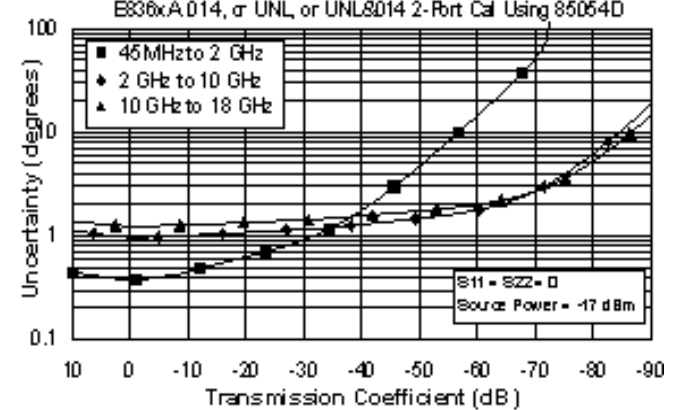

**Reflection Uncertainty (Specifications)**

**Magnitude**

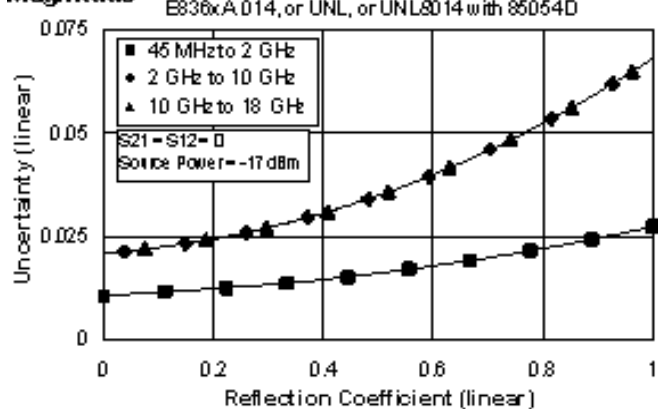

**Phase**

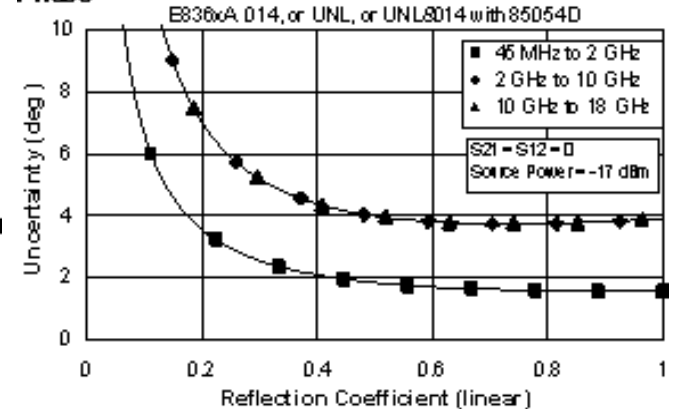

## E8363/4A Corrected System Performance with WR-28 Connectors

**Table 25. R11644A Calibration Kit  
Standard Configuration and Standard Power Range  
(E8363/4A)**

Applies to the, E8363/4A analyzers, R11644A (WR-28) calibration kit, 85133F flexible test port cable set with the R281A and R281B launch sets with the R281A and R281B launch sets, and a full 2-port calibration. Also applies to the following condition:

Environmental temperature 23° ±3 °C, with < 1 °C deviation from calibration temperature

Description	Specification (dB)
	<b>26.5 to 40 GHz</b>
Directivity	50
Source Match	50
Load Match	50
Reflection Tracking	±0.000 +0.03/°C
Transmission Tracking	±0.018 +0.03/°C

### Transmission Uncertainty (Specifications)

#### Magnitude

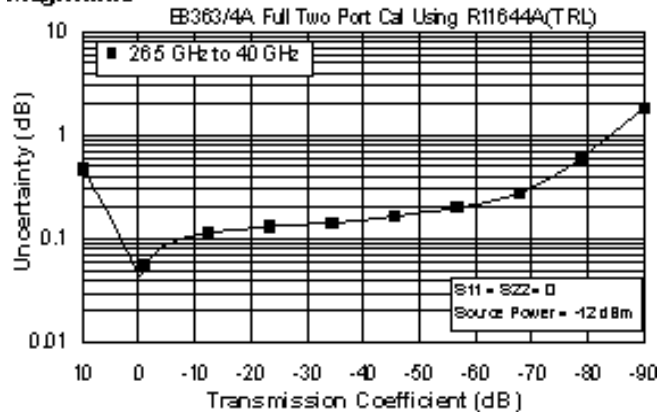

#### Phase

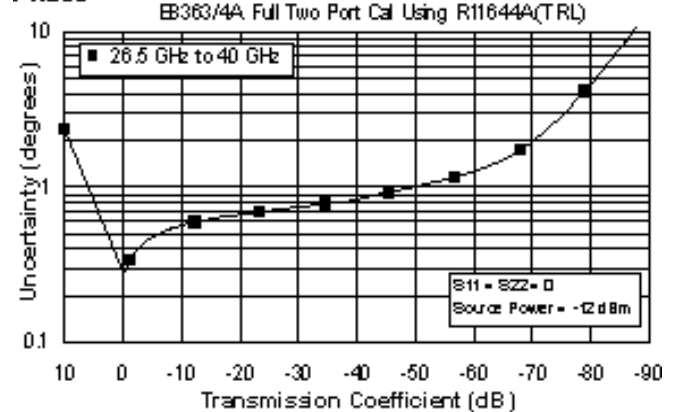

### Reflection Uncertainty (Specifications)

#### Magnitude

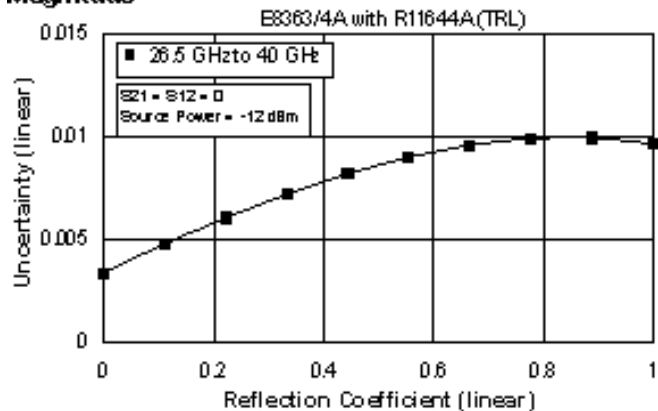

#### Phase

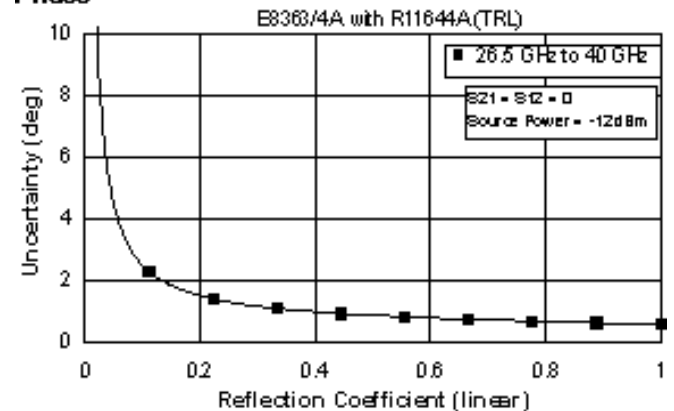

**Table 26. R11644A Calibration Kit**

**Extended Configuration and Standard Power Range (E8363/4A - Option 014)**

-OR-

**Standard Configuration and Extended Power Range & Bias-Tees (E8363/4A - Option UNL)**

-OR-

**Extended Configuration and Extended Power Range & Bias-Tees (E8363/4A - Option UNL&014)**

Applies to the, E8363/4A analyzers, R11644A (WR-28) calibration kit, 85133F flexible test port cable set with the R281A and R281B launch sets with the R281A and R281B launch sets, and a full 2-port calibration. Also applies to the following condition:

Environmental temperature 23° ±3 °C, with < 1 °C deviation from calibration temperature

Description	Specification (dB)
	<b>26.5 to 40 GHz</b>
Directivity	50
Source Match	50
Load Match	50
Reflection Tracking	±0.000 +0.03/°C
Transmission Tracking	±0.021 +0.03/°C

**Transmission Uncertainty (Specifications)**

**Magnitude**

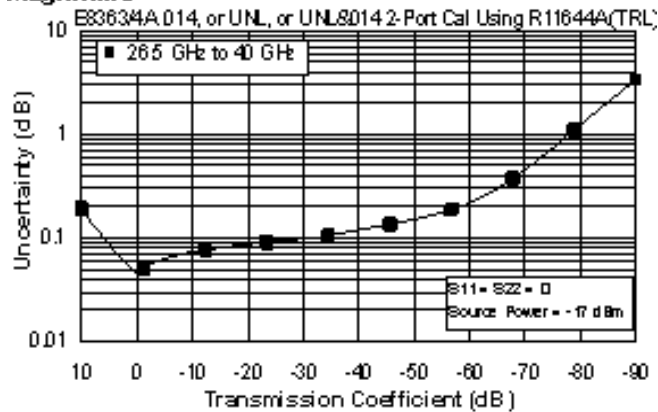

**Phase**

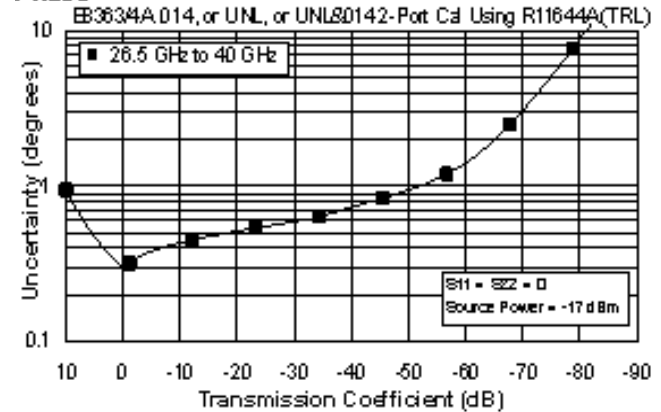

**Reflection Uncertainty (Specifications)**

**Magnitude**

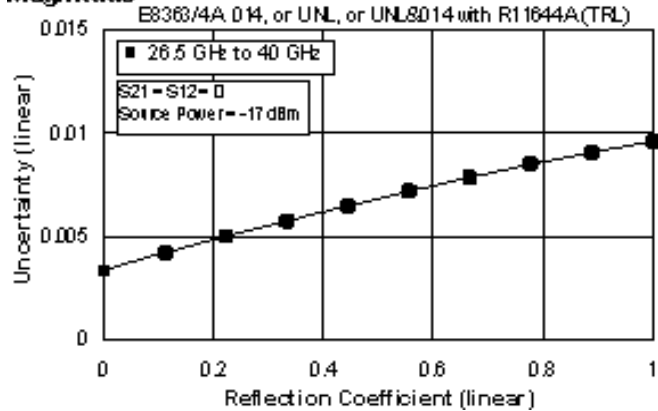

**Phase**

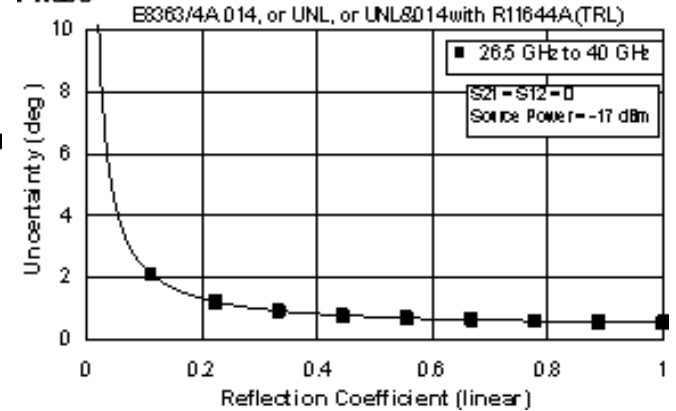

## E8363/4A Corrected System Performance with WR-42 Connectors

**Table 27. K11644A Calibration Kit  
Standard Configuration and Standard Power Range  
(E8363/4A)**

Applies to the, E8363/4A analyzers, K11644A (WR-42) calibration kit, 85134F flexible test port cable set, and a full 2-port calibration. Also applies to the following condition:

Environmental temperature  $23^{\circ} \pm 3^{\circ} \text{C}$ , with  $< 1^{\circ} \text{C}$  deviation from calibration temperature

Description	Specification (dB)	
	18 to 20 GHz	20 to 26.5 GHz
Directivity	50	50
Source Match	50	50
Load Match	50	50
Reflection Tracking	$\pm 0.000$ $+0.02/^{\circ}\text{C}$	$\pm 0.000$ $+0.02/^{\circ}\text{C}$
Transmission Tracking	$\pm 0.010$ $+0.02/^{\circ}\text{C}$	$\pm 0.012$ $+0.02/^{\circ}\text{C}$

### Transmission Uncertainty (Specifications)

#### Magnitude

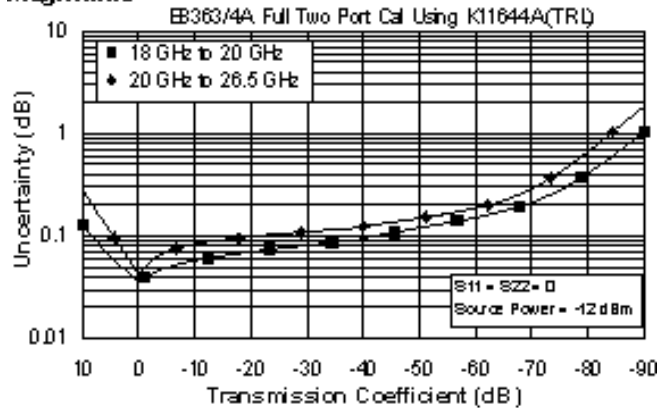

#### Phase

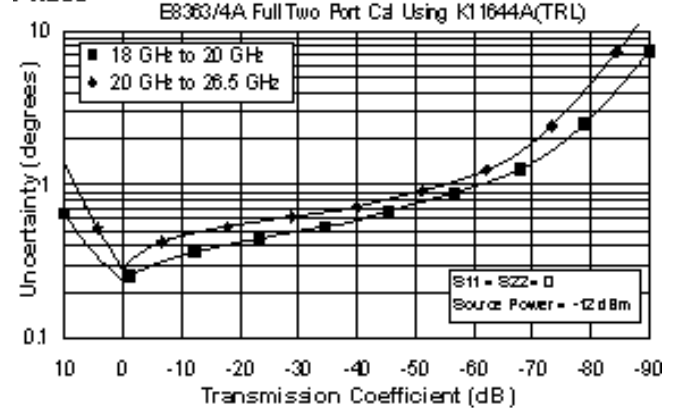

### Reflection Uncertainty (Specifications)

#### Magnitude

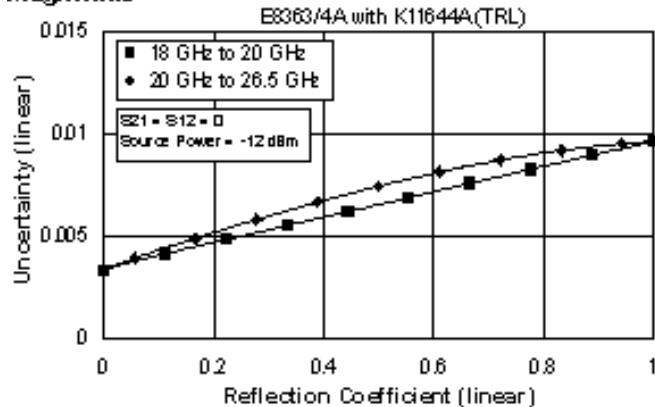

#### Phase

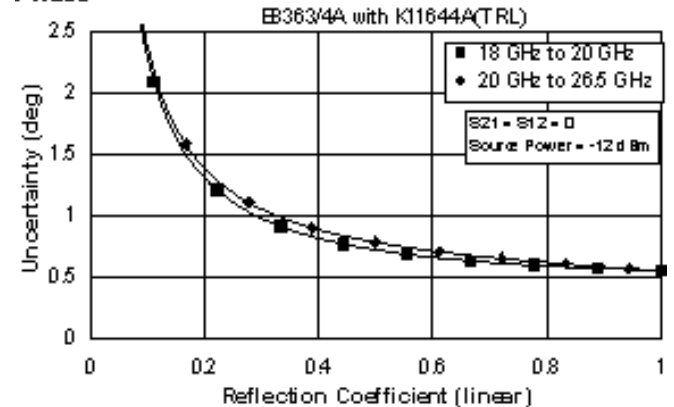

**Table 28. K11644A Calibration Kit**  
**Extended Configuration and Standard Power Range (E8363/4A - Option 014)**  
 -OR-  
**Standard Configuration and Extended Power Range & Bias-Tees (E8363/4A - Option UNL)**  
 -OR-  
**Extended Configuration and Extended Power Range & Bias-Tees (E8363/4A - Option UNL&014)**

Applies to the, E8363/4A analyzers, K11644A (WR-42) calibration kit, 85134F flexible test port cable set, and a full 2-port calibration. Also applies to the following condition:

Environmental temperature  $23^{\circ} \pm 3^{\circ} \text{C}$ , with  $< 1^{\circ} \text{C}$  deviation from calibration temperature

Description	Specification (dB)	
	18 to 20 GHz	20 to 26.5 GHz
Directivity	50	50
Source Match	50	50
Load Match	50	50
Reflection Tracking	$\pm 0.000$ $+0.02/^{\circ}\text{C}$	$\pm 0.000$ $+0.02/^{\circ}\text{C}$
Transmission Tracking	$\pm 0.016$ $+0.02/^{\circ}\text{C}$	$\pm 0.021$ $+0.02/^{\circ}\text{C}$

**Transmission Uncertainty (Specifications)**

**Magnitude**

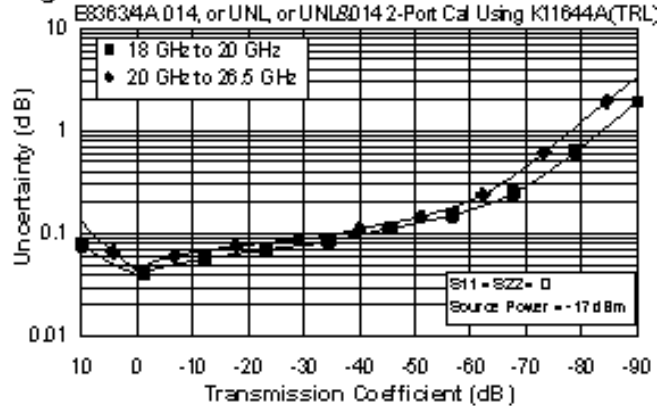

**Phase**

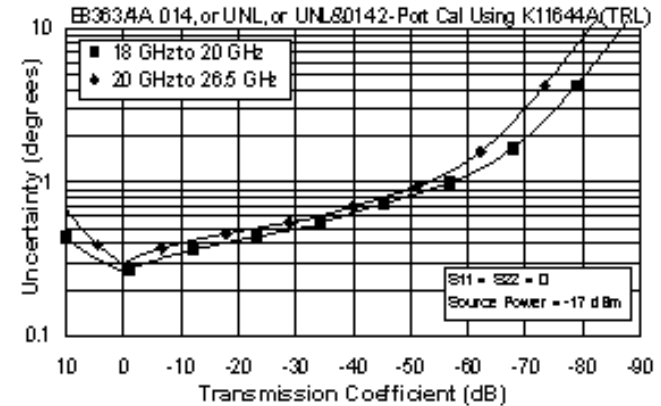

**Reflection Uncertainty (Specifications)**

**Magnitude**

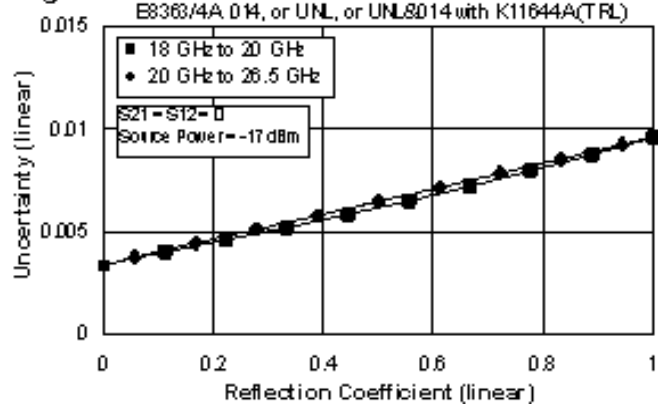

**Phase**

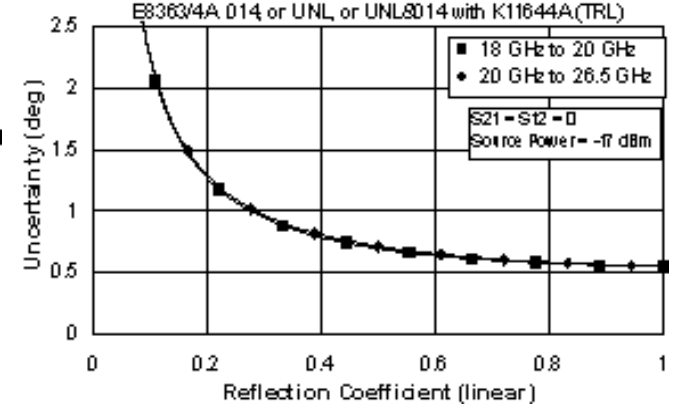

## E836xA Corrected System Performance with WR-62 Connectors

**Table 29. P11644A Calibration Kit  
Standard Configuration and Standard Power Range  
(E836xA)**

Applies to the, E836xA analyzers, R11644A (WR-62) calibration kit, 85132F flexible test port cable set, and a full 2-port calibration. Also applies to the following condition:

Environmental temperature  $23^{\circ} \pm 3^{\circ} \text{C}$ , with  $< 1^{\circ} \text{C}$  deviation from calibration temperature

Description	Specification (dB)
Directivity	50
Source Match	50
Load Match	50
Reflection Tracking	$\pm 0.000$ $+0.02/^{\circ}\text{C}$
Transmission Tracking	$\pm 0.012$ $+0.02/^{\circ}\text{C}$

### Transmission Uncertainty (Specifications)

#### Magnitude

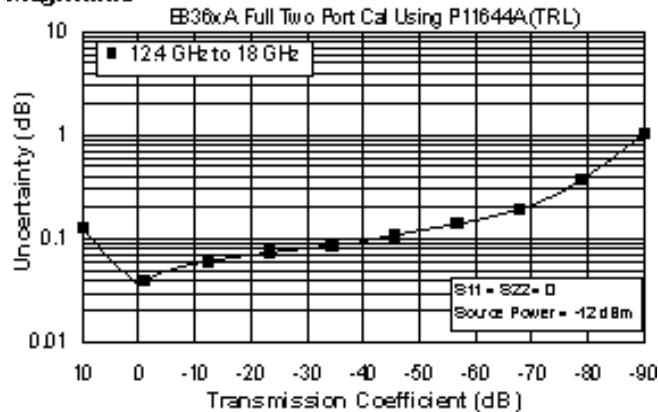

#### Phase

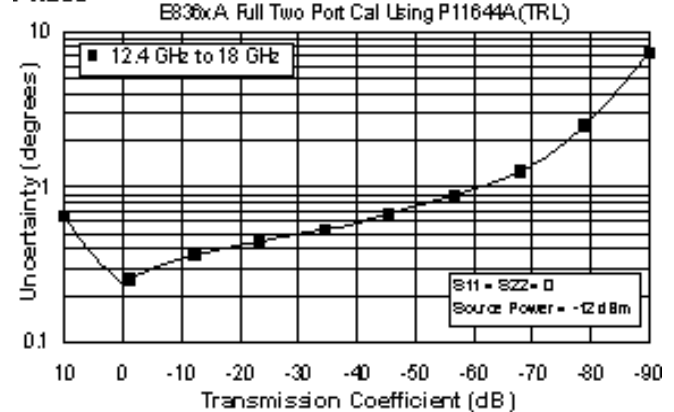

### Reflection Uncertainty (Specifications)

#### Magnitude

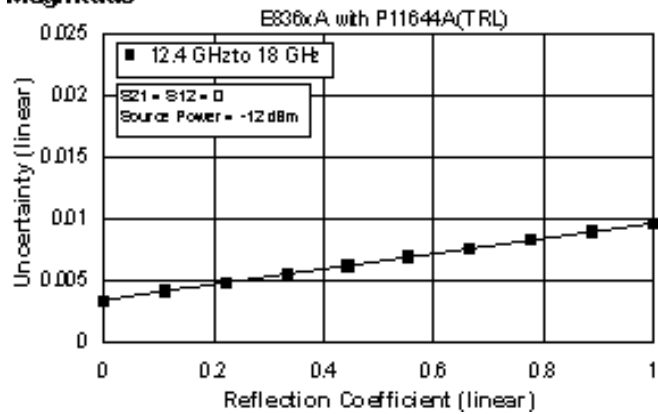

#### Phase

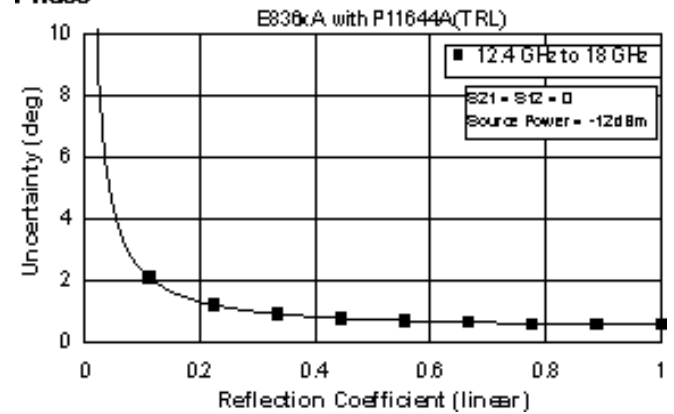



**Table 30. P11644A Calibration Kit**

**Extended Configuration and Standard Power Range (E836xA - Option 014)**

**-OR-**

**Standard Configuration and Extended Power Range & Bias-Tees (E836xA - Option UNL)**

**-OR-**

**Extended Configuration and Extended Power Range & Bias-Tees (E836xA - Option UNL&014)**

Applies to the, E836xA analyzers, P11644A (WR-62) calibration kit, 85132F flexible test port cable set, and a full 2-port calibration. Also applies to the following condition:

Environmental temperature  $23^{\circ} \pm 3^{\circ} \text{C}$ , with  $< 1^{\circ} \text{C}$  deviation from calibration temperature

Description	Specification (dB)
	<b>12.4 to 18 GHz</b>
Directivity	50
Source Match	50
Load Match	50
Reflection Tracking	$\pm 0.000$ $+0.02/^{\circ}\text{C}$
Transmission Tracking	$\pm 0.016$ $+0.02/^{\circ}\text{C}$

**Transmission Uncertainty (Specifications)**

**Magnitude**

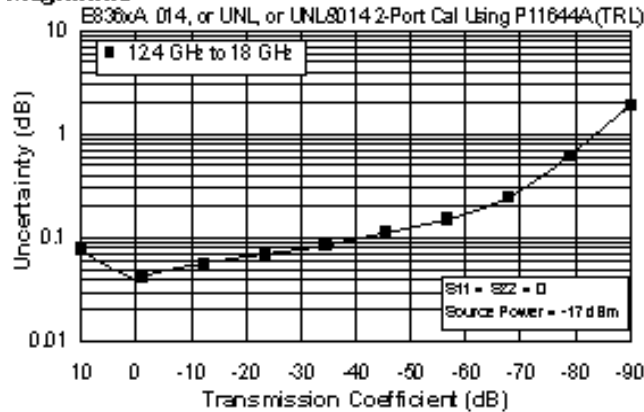

**Phase**

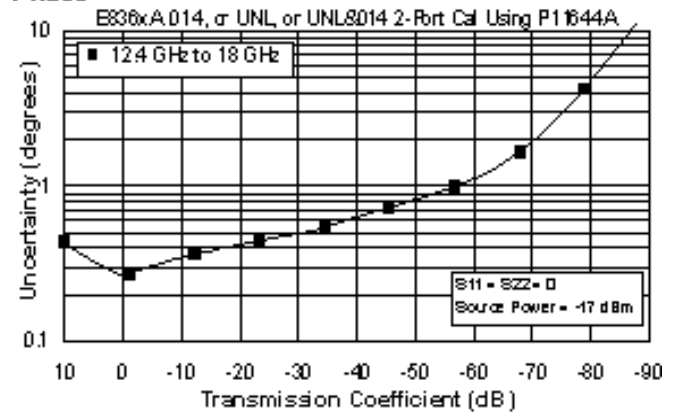

**Reflection Uncertainty (Specifications)**

**Magnitude**

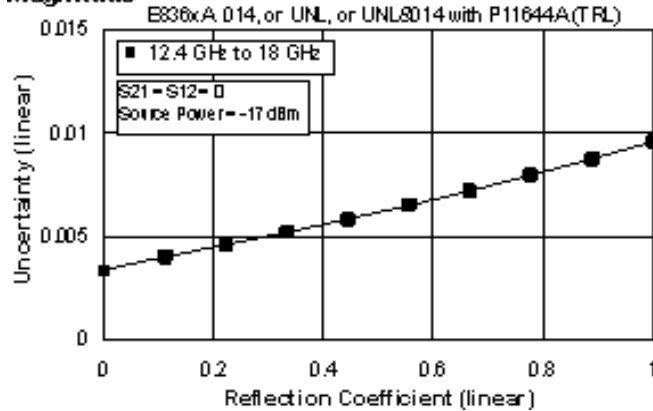

**Phase**

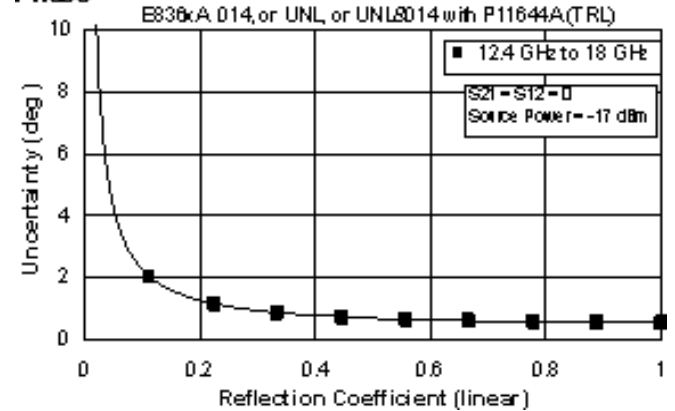

## E836xA Corrected System Performance with WR-90 Connectors

**Table 31. X11644A Calibration Kit  
Standard Configuration and Standard Power Range  
(E836xA)**

Applies to the, E836xA analyzers, X11644A (WR-90) calibration kit, 85133F flexible test port cable set, and a full 2-port calibration. Also applies to the following condition:

Environmental temperature  $23^{\circ} \pm 3^{\circ} \text{C}$ , with  $< 1^{\circ} \text{C}$  deviation from calibration temperature

Description	Specification (dB)	
	8.2 to 10 GHz	10 to 12.4 GHz
Directivity	50	50
Source Match	50	50
Load Match	50	50
Reflection Tracking	$\pm 0.000$ $+0.02/^{\circ}\text{C}$	$\pm 0.000$ $+0.02/^{\circ}\text{C}$
Transmission Tracking	$\pm 0.010$ $+0.02/^{\circ}\text{C}$	$\pm 0.012$ $+0.02/^{\circ}\text{C}$

### Transmission Uncertainty (Specifications)

#### Magnitude

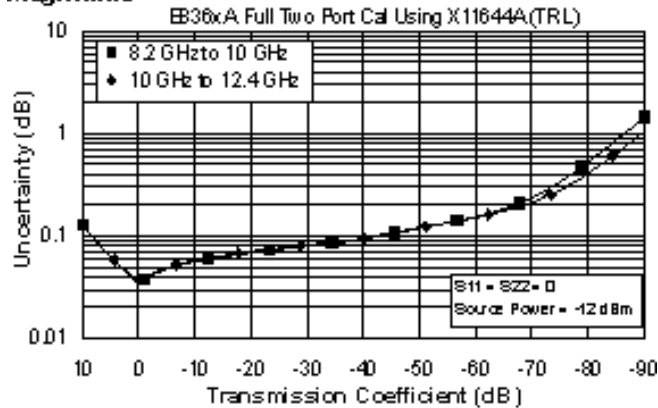

#### Phase

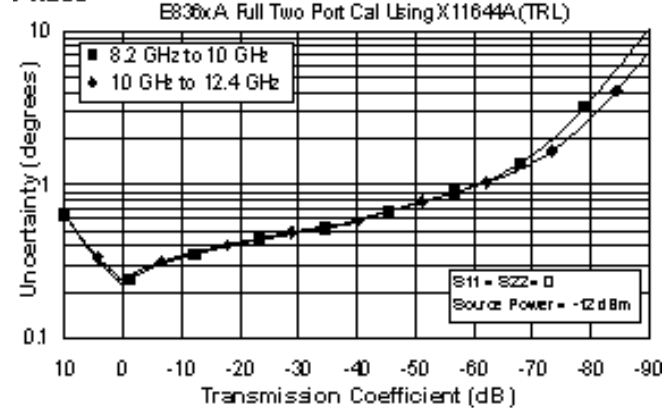

### Reflection Uncertainty (Specifications)

#### Magnitude

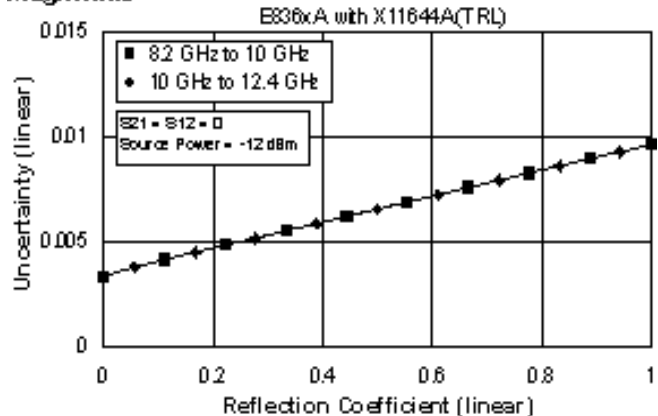

#### Phase

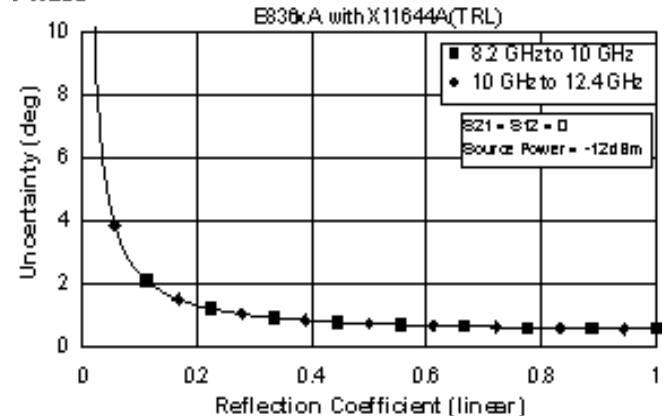

**Table 32. X11644A Calibration Kit**

**Extended Configuration and Standard Power Range (E836xA - Option 014)**

**-OR-**

**Standard Configuration and Extended Power Range & Bias-Tees (E836xA - Option UNL)**

**-OR-**

**Extended Configuration and Extended Power Range & Bias-Tees (E836xA - Option UNL&014)**

Applies to the, E836xA analyzers, X11644A (WR-90) calibration kit, 85133F flexible test port cable set, and a full 2-port calibration. Also applies to the following condition:

Environmental temperature 23° ±3 °C, with < 1 °C deviation from calibration temperature

Description	Specification (dB)	
	8.2 to 10 GHz	10 to 12.4 GHz
Directivity	50	50
Source Match	50	50
Load Match	50	50
Reflection Tracking	±0.000 +0.02/°C	±0.000 +0.02/°C
Transmission Tracking	±0.012 +0.02/°C	±0.016 +0.02/°C

**Transmission Uncertainty (Specifications)**

**Magnitude**

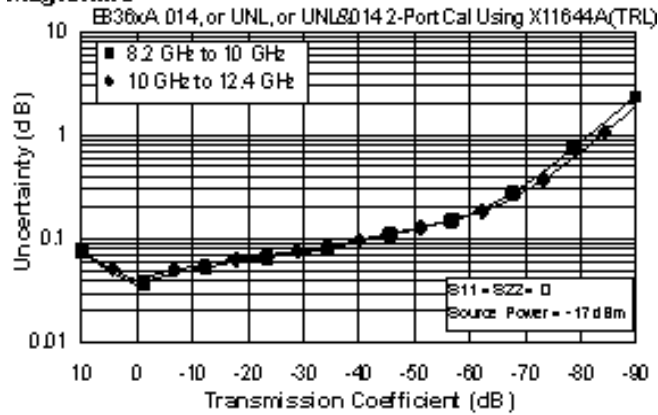

**Phase**

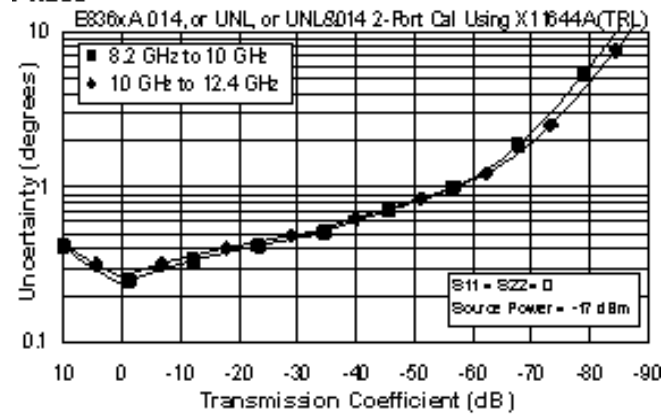

**Reflection Uncertainty (Specifications)**

**Magnitude**

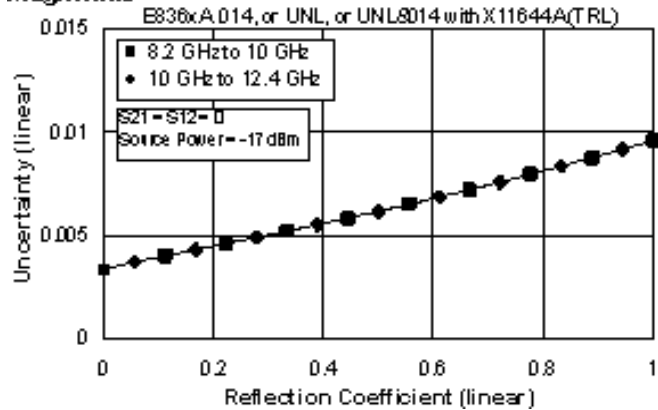

**Phase**

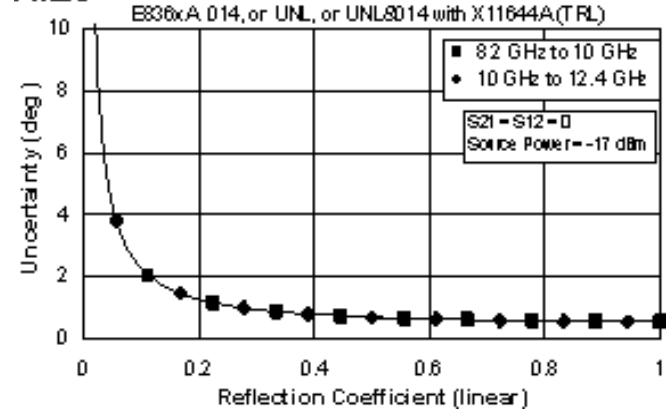

**Table 33. Uncorrected System Performance**

Specifications apply over environmental temperature of 23° ±3 °C, with < 1 °C deviation from the calibration temperature

Description	Specification	Supplemental Information
<b>Directivity</b>		
		<b>Typical:</b>
45 MHz to 2 GHz	24 dB	29 dB
2 GHz to 10 GHz	22 dB	25 dB
10 GHz to 20 GHz	16 dB	20 dB
20 GHz to 40 GHz	16 dB	20 dB
40 GHz to 45 GHz	15 dB	18 dB
45 GHz to 50 GHz	13 dB	18 dB
<b>Source Match - Standard</b>		
		<b>Typical:</b>
45 MHz to 2 GHz	23 dB	27 dB
2 GHz to 10 GHz	16 dB	19 dB
10 GHz to 20 GHz	14 dB	19 dB
20 GHz to 40 GHz	10 dB	14 dB
40 GHz to 45 GHz	9 dB	13.5 dB
45 GHz to 50 GHz	5.5 dB	9 dB
<b>Source Match - Opt UNL, 014 or UNL&amp;014</b>		
		<b>Typical:</b>
45 MHz to 2 GHz	18 dB	22.5 dB
2 GHz to 10 GHz	14 dB	18 dB
10 GHz to 20 GHz	12 dB	15 dB
20 GHz to 40 GHz	8 dB	10 dB
40 GHz to 45 GHz	7 dB	10 dB
45 GHz to 50 GHz	4 dB	6.5 dB
<b>Load Match - Standard</b>		
		<b>Typical:</b>
45 MHz to 2 GHz	23 dB	29 dB
2 GHz to 10 GHz	14 dB	16 dB
10 GHz to 20 GHz	10 dB	12 dB
20 GHz to 40 GHz	9 dB	12 dB
40 GHz to 45 GHz	9 dB	13 dB
45 GHz to 50 GHz	7 dB	10 dB
<b>Load Match - Opt UNL, 014 or UNL&amp;014</b>		
		<b>Typical:</b>
45 MHz to 2 GHz	17 dB	21.5 dB
2 GHz to 10 GHz	13 dB	16.5 dB
10 GHz to 20 GHz	10 dB	13 dB
20 GHz to 40 GHz	9 dB	11 dB
40 GHz to 45 GHz	8 dB	11 dB
45 GHz to 50 GHz	6 dB	8 dB
<b>Reflection Tracking</b>		
		<b>Typical:</b>
45 MHz to 20 GHz		±1.5
20 GHz to 40 GHz		±1.5
40 GHz to 50 GHz		±2.0

<b>Transmission Tracking<sup>a</sup></b>		
		<b>Typical:</b>
45 MHz to 2 GHz		±2.5 dB
2 GHz to 10 GHz		±2.0 dB
10 GHz to 20 GHz		±3.0 dB
20 GHz to 40 GHz		±4.5 dB
40 GHz to 45 GHz		±6.0 dB
45 GHz to 50 GHz		±6.0 dB
<b>Crosstalk - Standard</b>		
45 MHz to 1 GHz	-85 dB	
1 GHz to 2 GHz	-100 dB	
2 GHz to 20 GHz	-110 dB	
20 GHz to 40 GHz	-108 dB	
40 GHz to 45 GHz	-105 dB	
45 GHz to 50 GHz	-100 dB	
<b>Crosstalk - Option UNL or 014</b>		
45 MHz to 1 GHz	-85 dB	
1 GHz to 2 GHz	-100 dB	
2 GHz to 20 GHz	-109 dB	
20 GHz to 40 GHz	-106 dB	
40 GHz to 45 GHz	-103 dB	
45 GHz to 50 GHz	-98 dB	
<b>Crosstalk - Option UNL&amp;014</b>		
45 MHz to 1 GHz	-85 dB	
1 GHz to 2 GHz	-98 dB	
2 GHz to 10 GHz	-108 dB	
10 GHz to 20 GHz	-107 dB	
20 GHz to 40 GHz	-104 dB	
40 GHz to 45 GHz	-100 dB	
45 GHz to 50 GHz	-95 dB	

<sup>a</sup> Measurement conditions: normalized to a thru, measured with two shorts, 10 Hz IF bandwidth, averaging factor of 8, alternate mode, source power set to the lesser of the maximum power out or the maximum receiver power.

Table 34. Test Port Output<sup>a</sup>

Description	Specification				Supplemental
<b>Frequency Range</b>					
	<b>Standard</b>	<b>Opt 014</b>	<b>Opt UNL</b>	<b>Opt UNL&amp;014</b>	
E8362A	45 MHz to 20 GHz				
E8363A	45 MHz to 40 GHz				
E8364A	45 MHz to 50 GHz				
<b>Nominal Power<sup>b</sup></b>					
	-12 dBm	-17 dBm	-17 dBm	-17 dBm	
<b>Frequency Resolution</b>					
	1 Hz				
<b>CW Accuracy</b>					
	+/-1 ppm				
<b>Frequency Stability</b>					
					+/-1 ppm 0° to 40° C, typical +/-0.2 ppm/yr, typical
<b>Power Level Accuracy</b>					
45 MHz to 10 GHz	+/-1.5 dB	+/-1.5 dB	+/-1.5 dB	+/-1.5 dB	Variation from nominal power in range 0 (step attenuator at 0 dB)
10 GHz to 20 GHz	+/-2.0 dB	+/-2.0 dB	+/-2.0 dB	+/-2.0 dB	
20 GHz to 40 GHz	+/-3.0 dB	+/-3.0 dB	+/-3.0 dB	+/-3.0 dB	
40 GHz to 45 GHz	+/-3.0 dB	+/-3.5 dB	+/-3.0 dB	+/-3.5 dB	
45 GHz to 50 GHz	+/-3.0 dB	+/-4.0 dB	+/-3.0 dB	+/-4.0 dB	
<b>Power Level Linearity</b>					
45 MHz to 20 GHz	+/-1.0 dB	+/-1.0 dB	+/-1.0 dB <sup>c</sup>	+/-1.0 dB <sup>c</sup>	Test reference is at the nominal power level (step attenuator at 0 dB)
20 GHz to 40 GHz	+/-1.0 dB	+/-1.0 dB	+/-1.0 dB <sup>c</sup>	+/-1.0 dB <sup>c</sup>	
40 GHz to 50 GHz	+/-1.0 dB	+/-1.0 dB	+/-1.0 dB	+/-1.0 dB	
<b>Power Range<sup>d</sup></b>					
45 MHz to 10 GHz	-25 to +5 dBm	-25 to +5 dBm	-87 to +3 dBm	-87 to +3 dBm	
10 GHz to 20 GHz	-24 to +3 dBm	-25 to +2 dBm	-86 to +1 dBm	-87 to 0 dBm	
20 GHz to 30 GHz	-23 to 0 dBm	-25 to -2 dBm	-85 to -2 dBm	-87 to -4 dBm	
30 GHz to 40 GHz	-23 to -4 dBm	-25 to -6 dBm	-85 to -6 dBm	-87 to -8 dBm	
40 GHz to 45 GHz	-25 to -5 dBm	-27 to -7 dBm	-87 to -9 dBm	-87 to -11 dBm	
45 GHz to 50 GHz	-25 to -10 dBm	-27 to -12 dBm	-87 to -15 dBm	-87 to -17 dBm	

<b>Power Sweep Range (ALC)</b>					
45 MHz to 10 GHz	30 dB	30 dB	30 dB	30 dB	ALC range starts at maximum leveled output power and goes down to power level indicated by dB amount specified
10 GHz to 20 GHz	27 dB	27 dB	27 dB	27 dB	
20 GHz to 30 GHz	23 dB	23 dB	23 dB	23 dB	
30 GHz to 40 GHz	19 dB	19 dB	19 dB	19 dB	
40 GHz to 45 GHz	20 dB	20 dB	18 dB	16 dB	
45 GHz to 50 GHz	15 dB	15 dB	12 dB	10 dB	
<b>Power Resolution</b>					
	0.01 dB				
<b>Phase Noise</b>					
10 kHz offset from center frequency, nominal power at test port					
45 MHz to 10 GHz					-70 dBc, typical
10 GHz to 20 GHz					-65 dBc, typical
20 GHz to 40 GHz					-55 dBc, typical
40 GHz to 50 GHz					-55 dBc, typical
<b>Harmonics (2nd or 3rd)</b>					
					-23 dBc typical, in power range 0
<b>Non-Harmonic Spurious (at Nominal Output Power)</b>					
45 MHz to 20 GHz					-50 dBc typical, for offset frequency > 1 kHz
20 GHz to 40 GHz					-30 dBc typical, for offset frequency > 1 kHz
40 GHz to 50 GHz					-30 dBc typical, for offset frequency > 1 kHz

<sup>a</sup> Source output performance on Port 1 only. Port 2 output performance is a characteristic.

<sup>b</sup> Preset power.

<sup>c</sup> 1.5 dB for power <= -23 dBm.

<sup>d</sup> Power to which the source can be set and phase lock is assured.

**Table 35: Test Port Input**

Description	Specification				Supplemental
	Standard	Opt 014	Opt UNL	Opt UNL&014	
<b>Test Port Noise Floor<sup>1</sup></b>					
<b>10 Hz IF Bandwidth</b>					
45 MHz to 500 MHz <sup>2</sup>	<-89 dBm	<-89 dBm	<-89 dBm	<-89 dBm	
500 MHz to 2 GHz	<-114 dBm	<-114 dBm	<-114 dBm	<-114 dBm	
2 GHz to 10 GHz	<-117 dBm	<-117 dBm	<-117 dBm	<-117 dBm	
10 GHz to 20 GHz	<-120 dBm	<-119 dBm	<-120 dBm	<-119 dBm	
20 GHz to 40 GHz	<-120 dBm	<-113 dBm	<-114 dBm	<-113 dBm	
40 GHz to 50 GHz	<-114 dBm	<-112 dBm	<-114 dBm	<-112 dBm	
<b>1 Hz IF Bandwidth</b>					
45 MHz to 500 MHz <sup>2</sup>	<-69 dBm	<-69 dBm	<-69 dBm	<-69 dBm	
500 MHz to 2 GHz	<-94 dBm	<-94 dBm	<-94 dBm	<-94 dBm	
2 GHz to 10 GHz	<-97 dBm	<-97 dBm	<-97 dBm	<-97 dBm	
10 GHz to 20 GHz	<-100 dBm	<-99 dBm	<-100 dBm	<-99 dBm	
20 GHz to 40 GHz	<-94 dBm	<-93 dBm	<-94 dBm	<-93 dBm	
40 GHz to 50 GHz	<-94 dBm	<-92 dBm	<-94 dBm	<-92 dBm	
<b>Direct Receiver Access Input Noise Floor<sup>1</sup></b>					
<b>10 Hz IF Bandwidth</b>					
45 MHz to 500 MHz <sup>2</sup>		<-127 dBm		<-127 dBm	
500 MHz to 2 GHz		<-133 dBm		<-133 dBm	
2 GHz to 10 GHz		<-132 dBm		<-132 dBm	
10 GHz to 20 GHz		<-134 dBm		<-134 dBm	
20 GHz to 40 GHz		<-125 dBm		<-125 dBm	
40 GHz to 50 GHz		<-123 dBm		<-123 dBm	



<b>1 Hz IF Bandwidth</b>					
45 MHz to 500 MHz		<-107 dBm		<-107 dBm	
500 MHz to 2 GHz		<-113 dBm		<-113 dBm	
2 GHz to 10 GHz		<-112 dBm		<-112 dBm	
10 GHz to 20 GHz		<-114 dBm		<-114 dBm	
20 GHz to 40 GHz		<-105 dBm		<-105 dBm	
40 GHz to 50 GHz		<-103 dBm		<-103 dBm	
<b>Receiver Compression Level</b>					
45 MHz to 20 GHz	<0.6 dB compression at +5 dBm				
20 GHz to 30 GHz	<0.6 dB compression at 0 dBm				
30 GHz to 40 GHz	<0.6 dB compression at -3 dBm				
40 GHz to 50 GHz	<0.6 dB compression at -3 dBm				
<b>System Compression Level</b>					
	maximum output power			See <a href="#">dynamic accuracy table</a>	
<b>Trace Noise Magnitude</b>					
1 kHz IF bandwidth. Ratio measurement, nominal power at test port.					
45 MHz to 500 MHz	<0.010 dB rms				
500 MHz to 20 GHz	<0.006 dB rms				
20 GHz to 40 GHz	<0.006 dB rms				
40 GHz to 50 GHz	<0.006 dB rms				
<b>Trace Noise Phase</b>					
1 kHz IF bandwidth. Ratio measurement, nominal power at test port.					
45 MHz to 500 MHz <sup>3</sup>	<0.100° rms				
500 MHz to 20 GHz	<0.060° rms				
20 GHz to 40 GHz	<0.100° rms				
40 GHz to 50 GHz	<0.100° rms				

Reference Level Magnitude					
Range	+/-200 dB				
Resolution	0.001 dB				
Reference Level Phase					
Range	+/-500°				
Resolution	0.01°				
Stability Magnitude <sup>4</sup>					
Typical ratio measurement, made at the test port.					
45 MHz to 20 GHz					+/-0.02 dB/°C
20 GHz to 40 GHz					+/-0.03 dB/°C
40 GHz to 50 GHz					+/-0.04 dB/°C
Stability Phase <sup>4</sup>					
Typical ratio measurement, measured at the test port.					
45 MHz to 20 GHz					+/-0.2°/°C
20 GHz to 40 GHz					+/-0.5°/°C
40 GHz to 50 GHz					+/-0.8°/°C
Damage Input Level					
Test Port 1 and 2					+20 dBm or +/-40 VDC, typical
R1, R2 in					+15 dBm or +/-15 VDC, typical
A, B in					+15 dBm or +/-15 VDC, typical
Coupler Thru					+30 dBm or +/-40 VDC, typical
Coupler Arm					+30 dBm or +/-7 VDC, typical

<sup>1</sup>Total average (rms) noise power calculated as the mean value of a linear magnitude trace expressed in dBm.

<sup>2</sup>Noise floor may be degraded by 10 dB at particular frequencies (multiples of 5 MHz) due to spurious receiver residuals.

<sup>3</sup>Trace noise magnitude may be degraded to 20 mdB rms at harmonic frequencies of the first IF (8.33 MHz) below 80 MHz.

<sup>4</sup>Stability is defined as a ratio measurement made at the test port.

**Table 36. Dynamic Accuracy (Specification<sup>a</sup>)**

Accuracy of the test port input power reading is relative to the reference input power level. Applies to input ports 1 and 2 with the following conditions:

- IF bandwidth = 10 Hz
- Test port powers = > -50 dBm and < 0 dBm

**Magnitude**

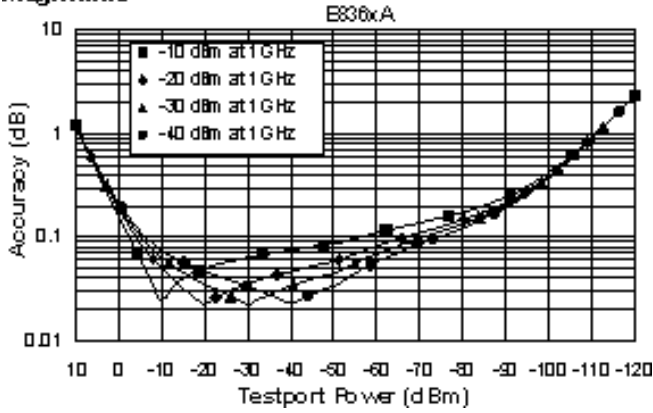

**Phase**

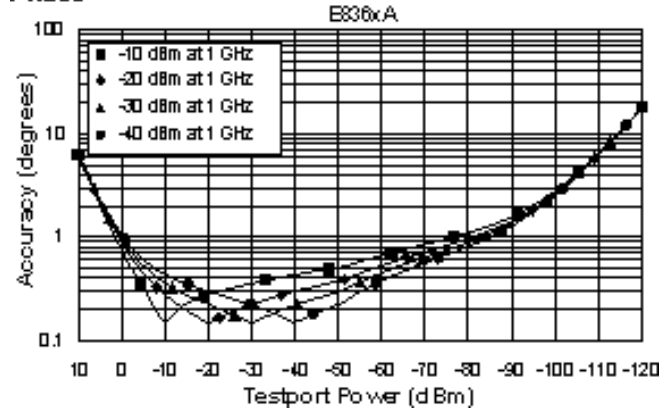

<sup>a</sup> Dynamic accuracy is verified with the following measurements:

- compression over frequency
- IF linearity at a single frequency of 1.195 GHz and a reference level of -20 dBm

**Table 37. Test Port Input (Group Delay)<sup>a</sup>**

Description	Specification	Supplemental Information
Aperture (selectable)	(frequency span)/(number of points - 1)	
Maximum Aperture	20% of frequency span	
Range	0.5 x (1/minimum aperture)	
Maximum Delay		Limited to measuring no more than 180° of phase change within the minimum aperture.)
Accuracy		See graph below. Char.

The following graph shows characteristic group delay accuracy with full 2-port calibration and a 10 Hz IF bandwidth. Insertion loss is assumed to be < 2 dB and electrical length to be ten meters.

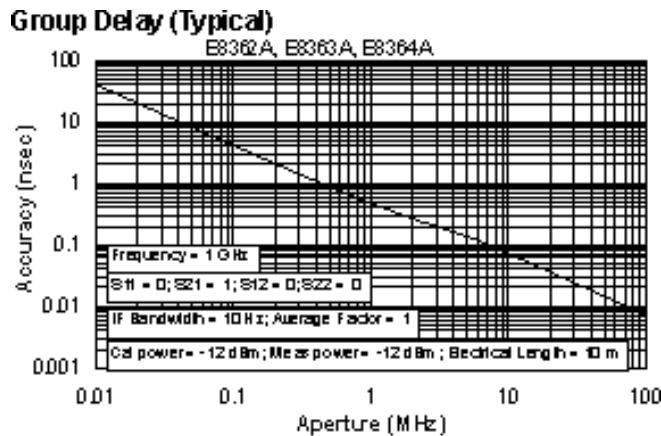

In general, the following formula can be used to determine the accuracy, in seconds, of specific group delay measurement:

$$\pm \text{Phase Accuracy (deg)} / [360 \times \text{Aperture (Hz)}]$$

Depending on the aperture and device length, the phase accuracy used is either incremental phase accuracy or worst case phase accuracy.

<sup>a</sup> Group delay is computed by measuring the phase change within a specified frequency step (determined by the frequency span and the number of points per sweep).

## General Information

**Table 38. Miscellaneous Information**

Description	Specification	Supplemental Information
System IF Bandwidth Range		1 Hz to 40 kHz, nominal
CPU		Intel® 500 MHz Pentium® III

**Table 39. Front Panel Information**

Description	Supplemental Information
<b>RF Connectors</b>	
<b>E8362A</b>	
Type	3.5 mm (male), 50 ohm, (nominal)
Center Pin Recession	0.002 in. (characteristic)
<b>E8363/4A</b>	
Type	2.4 mm (male), 50 ohm, (nominal)
Center Pin Recession	0.002 in. (characteristic)
<b>Display</b>	
Size	21.3 cm (8.4 in) diagonal color active matrix LCD; 640 (horizontal) X 480 (vertical) resolution; 59.83 Hz vertical refresh rate; 31.41 Hz horizontal refresh rate
Refresh Rate	Vertical 59.83 Hz; Horizontal 31.41 Hz
<b>Display Range</b>	
Magnitude	±200 dB (at 20 dB/div), max
Phase	±180°, max
Polar	10 pUnits, min 1000 Units, max
<b>Display Resolution</b>	
Magnitude	0.001 dB/div, min
Phase	0.01°/div, min
<b>Marker Resolution</b>	
Magnitude	0.001 dB, min
Phase	0.01°, min
Polar	0.01 mUnit, min; 0.01°, min

**Table 40. Rear Panel Information**

Description	Supplemental Information
<b>10 MHz Reference In</b>	
Connector	BNC, female
Input Frequency	10 MHz ± 10 ppm, typical
Input Level	-15 dBm to +20 dBm, typical
Input Impedance	200 Ω, nom.
<b>10 MHz Reference Out</b>	
Connector	BNC, female
Output Frequency	10 MHz ± 1 ppm, typical
Signal Type	Sine Wave, typical
Output Level	+10 dBm ± 4 dB into 50 Ω, typical
Output Impedance	50 Ω, nominal
Harmonics	<-40 dBc, typical
<b>VGA Video Output</b>	
Connector	15-pin mini D-Sub; Drives VGA compatible monitors
Devices Supported:	
	<b>Resolutions:</b>
Flat Panel (TFT)	1024 X 768, 800 X 600, 640 X 480
Flat Panel (DSTN)	800 X 600, 640 X 480
CRT Monitor	1280 X 1024, 1024 X 768, 800 X 600, 640 X 480
	Simultaneous operation of the internal and external displays is allowed, but with 640 X 480 resolution only. If you change resolution, you can only view the external display (internal display will "white out").
<b>Test Set IO</b>	
	25-pin D-Sub connector, available for external test set control

<b>Aux IO</b>	
	25-pin D-Sub connector, male, analog and digital IO
<b>Handler IO</b>	
	36-pin parallel I/O port; all input/output signals are default set to negative logic; can be reset to positive logic via GPIB command
<b>GPIB</b>	
	24-pin D-sub (Type D-24), female; compatible with IEEE-488.
<b>Parallel Port (LPT1)</b>	
	25-pin D-Sub miniature connector, female; provides connection to printers or any other parallel port peripherals
<b>Serial Port (COM 1)</b>	
	9-pin D-Sub, male; compatible with RS-232
<b>USB Port</b>	
	Universal Serial Bus jack, Type A configuration (4 contacts inline, contact 1 on left); female
Contact 1	Vcc: 4.75 to 5.25 VDC, 500 mA, maximum
Contact 2	-Data
Contact 3	+Data
Contact 4	Ground
<b>LAN</b>	
	10/100BaseT Ethernet, 8-pin configuration; auto selects between the two data rates
<b>Line Power<sup>a</sup></b>	
Frequency	48 Hz to 66 Hz
Voltage at 115 V Setting	90 to 132 VAC; 120 VAC, nominal
Voltage at 220 V Setting	198 to 264 VAC; 240 VAC, nominal
VA Max	600 VA maximum

<sup>a</sup> A third-wire ground is required.

**Table 41. Analyzer Environment and Dimensions**

<b>Description</b>	<b>Supplemental Information</b>		
<b>General Environmental</b>			
RFI/EMI Susceptibility	Defined by CISPR Pub. 11, Group 1, Class A, and IEC 50082-1		
ESD	Minimize using static-safe work procedures and an antistatic bench mat		
Dust	Minimize for optimum reliability		
<b>Operating Environment</b>			
Temperature	0 °C to +40 °C Instrument powers up, phase locks, and displays no error messages within this temperature range (except for "source unlevelled" error message that may occur at temperature extremes when power approaches limits of ALC range).		
Error-Corrected Temperature Range	23°C ± 3°C with less than 1°C deviation from calibration temp.		
Humidity	5% to 95% at +40 °C		
Altitude	0 to 4500 m (14,760 ft.)		
<b>Non-Operating Storage Environment</b>			
Temperature	-40 °C to +70 °C		
Humidity	0% to 90% at +65 °C (non-condensing)		
Altitude	0 to 15,240 m (50,000 ft.)		
<b>Cabinet Dimensions</b>			
	<b>Height</b>	<b>Width</b>	<b>Depth</b>
Excluding front and rear panel hardware and feet	267 mm 10.5 in	425 mm 16.75 in	426 mm 16.8 in
As shipped - includes front panel connectors, rear panel bumpers, and feet.	305 mm 12.0 in	425 mm 16.75 in	470 mm 18.5 in
As shipped plus handles	305 mm 12.0 in	458 mm 18 in	502 mm 19.75 in
As shipped plus rack-mount flanges	305 mm 12.0 in	483 mm 19 in	470 mm 18.5 in
As shipped plus handles and flanges	305 mm 12.0 in	483 mm 19 in	502 mm 19.75 in
<b>Weight</b>			
<b>Net</b>			
E8362A	28.6 kg (63.5 lb), nominal		
E8363/4A	29 kg (64 lb), nominal		
<b>Shipping</b>			
E8362A	35.8 kg (79.5 lb), nominal		
E8363/4A	36.3 kg 80 lb), nominal		

## Measurement Throughput Summary

Table 42. Typical Cycle Time<sup>a,b</sup> (ms) for Measurement Completion

	Number of Points			
	51	201	401	1601
<b>Start 13.5 GHz, Stop 16.5 GHz, 35 kHz IF bandwidth</b>				
Uncorrected, 1-port cal	21	23	28	65
2-Port cal	52	57	70	152
<b>Start 45 MHz, Stop 10 GHz, 35 kHz IF bandwidth</b>				
Uncorrected, 1-port cal	71	79	84	110
2-Port cal	153	171	182	243
<b>Start 45 MHz, Stop 20 GHz, 35 kHz IF bandwidth</b>				
Uncorrected, 1-port cal	103	116	121	139
2-Port cal	216	245	256	303
<b>Start 45 MHz, Stop 40 GHz, 35 kHz IF bandwidth</b>				
Uncorrected, 1-port cal	145	181	190	232
2-Port cal	293	367	382	428
<b>Start 45 MHz, Stop 50 GHz, 35 kHz IF bandwidth</b>				
Uncorrected, 1-port cal	163	210	218	256
2-Port cal	332	425	442	487
<b>Time Domain<sup>c</sup> (increase over uncorrected sweep time)</b>				
Conversions	< 1	< 1	4	13
Gating	< 1	< 1	4	17

<sup>a</sup> Typical performance.

<sup>b</sup> Includes sweep time, retrace time and band-crossing time. Analyzer display turned off with DISPLAY:ENABLE OFF. Add 21 ms for display on. Data for one trace (S11) measurement.

<sup>c</sup> Option 010 only.



**Table 43. Cycle Time vs IF Bandwidth<sup>a</sup>**

Applies to the Preset condition (201 points, correction off) except for the following changes:

- CF = 1 GHz
- Span = 100 MHz
- Display off (add 21 ms for display on)

IF Bandwidth (Hz)	Cycle Time (ms) <sup>b</sup>
40,000	8
35,000	9
30,000	11
20,000	13
10,000	28
7000	36
5000	48
3000	72
1000	196
300	620
100	3853
30	8041
10	19855

<sup>a</sup> Typical performance.

<sup>b</sup> Cycle time includes sweep and retrace time.

**Table 44. Cycle Time vs Number of Points<sup>a</sup>**

Applies to the Preset condition (35 kHz IF bandwidth, correction off) except for the following changes:

- CF = 1 GHz
- Span = 100 MHz
- Display off (add 21 ms for display on)

Number of Points	Cycle Time (ms) <sup>b</sup>
3	4
11	4
51	5
101	6
201	9
401	16
801	29
1601	55

<sup>a</sup> Typical performance.

<sup>b</sup> Cycle time includes sweep and retrace time.

**Table 45. Data Transfer Time (ms)<sup>a</sup>**

	<b>Number of Points</b>			
	<b>51</b>	<b>201</b>	<b>401</b>	<b>1601</b>
<b>SCPI over GPIB</b>				
<b>(program executed on external PC)<sup>a</sup></b>				
32-bit floating point	3	7	12	43
64-bit floating point	4	12	22	84
ASCII	18	64	124	489
<b>SCPI over 100 Mbit/s LAN</b>				
<b>(program executed on external PC)<sup>b</sup></b>				
32-bit floating point	1	1	1	1
64-bit floating point	1	1	1	2
ASCII	5	15	26	96
<b>SCPI (program executed in the analyzer)<sup>c</sup></b>				
32-bit floating point	1	1	2	3
64-bit floating point	1	2	2	4
ASCII	8	29	56	222
<b>COM (program executed in the analyzer)<sup>d</sup></b>				
32-bit floating point	1	1	1	1
Variant type	1	1	2	6
<b>DCOM over 100 Mbit/s LAN</b>				
<b>(program executed on external PC)<sup>f</sup></b>				
32-bit floating point	1	1	1	2
Variant type	1	3	6	19

<sup>a</sup>Typical performance

---

**Note:** Specifications for Recall & Sweep Speed are not provided for the E836xA analyzers.

---

## Specifications: Front-Panel Jumpers

### Models E8362A, E8363A, and E8364A Option 014

See [Front-panel jumper](#) configurations.

**NOTE:** The standard E8362A /63A/ 64A has no front-panel jumpers.

Table 46: Measurement Receiver Inputs (Rcvr A In, Rcvr B In)

Description	Specification	Supplemental Information
<b>Maximum Input Level</b>		
<b>E8362A:</b>		
45 MHz to 500 MHz		-15 dBm, typical
500 MHz to 2 GHz		-11 dBm, typical
2 GHz to 10 GHz		-11 dBm, typical
10 GHz to 20 GHz		-11 dBm, typical
<b>E8363A:</b>		
45 MHz to 500 MHz		-14 dBm, typical
500 MHz to 2 GHz		-10 dBm, typical
2 GHz to 10 GHz		-10 dBm, typical
10 GHz to 20 GHz		-10 dBm, typical
20 GHz to 30 GHz		-14.5 dBm, typical
30 GHz to 40 GHz		-16.5 dBm, typical
<b>E8364A:</b>		
45 MHz to 500 MHz		- 14 dBm, typical
500 MHz to 2 GHz		- 10 dBm, typical
2 GHz to 10 GHz		- 10 dBm, typical
10 GHz to 20 GHz		- 10 dBm, typical
20 GHz to 30 GHz		- 14.5 dBm, typical
30 GHz to 40 GHz		- 16.5 dBm, typical
40 GHz to 45 GHz		- 16 dBm, typical
45 GHz to 50 GHz		- 15 dBm, typical
<b>Noise Floor</b>		
<b>E8362A:</b>		
	<b>10 Hz IF Bandwidth</b>	
45 MHz to 500 MHz	< -109 dBm	
500 MHz to 2 GHz	< -130 dBm	
2 GHz to 10 GHz	< -133 dBm	
10 GHz to 20 GHz	< -135 dBm	
	<b>1 kHz IF Bandwidth</b>	
45 MHz to 500 MHz	< -89 dBm	
500 MHz to 2 GHz	< -110 dBm	
2 GHz to 10 GHz	< -113 dBm	
10 GHz to 20 GHz	< -115 dBm	

<b>E8363A:</b>		
	<b>10 Hz IF Bandwidth</b>	
45 MHz to 500 MHz	< -127 dBm	
500 MHz to 2 GHz	< -133 dBm	
2 GHz to 10 GHz	< -132 dBm	
10 GHz to 20 GHz	< -134 dBm	
20 GHz to 40 GHz	< -125 dBm	
	<b>1 kHz IF Bandwidth</b>	
45 MHz to 500 MHz	< -107 dBm	
500 MHz to 2 GHz	< -113 dBm	
2 GHz to 10 GHz	< -112 dBm	
10 GHz to 20 GHz	< -114 dBm	
20 GHz to 40 GHz	< -105 dBm	
<b>E8364A:</b>		
	<b>10 Hz IF Bandwidth</b>	
45 MHz to 500 MHz	< - 127 dBm	
500 MHz to 2 GHz	< - 133 dBm	
2 GHz to 10 GHz	< - 132 dBm	
10 GHz to 20 GHz	< - 134 dBm	
20 GHz to 40 GHz	< - 125 dBm	
40 GHz to 50 GHz	< - 123 dBm	
	<b>1 kHz IF Bandwidth</b>	
45 MHz to 500 MHz	< -107 dBm	
500 MHz to 2 GHz	< -113 dBm	
2 GHz to 10 GHz	< -112 dBm	
10 GHz to 20 GHz	< -114 dBm	
20 GHz to 40 GHz	< -105 dBm	
40 GHz to 50 GHz	< -103 dBm	
<b>Damage Level</b>		
E8362A		+ 15 dBm, typical
E8363A		+ 15 dBm, typical
E8364A		+ 15 dBm, typical
<b>Maximum DC Level</b>		
E8362A		+ 15 V, typical
E8363A		+ 15 V, typical
E8364A		+ 15 V, typical

**Table 47: Reference Receiver Inputs (Rcvr R1, Rcvr R2)**

<b>Description</b>	<b>Specification</b>	<b>Supplemental Information</b>
<b>Maximum Input Level</b>		
<b>E8362A:</b>		
45 MHz to 500 MHz		-15 dBm, typical
500 MHz to 2 GHz		-11 dBm, typical
2 GHz to 10 GHz		-11 dBm, typical
10 GHz to 20 GHz		-11 dBm, typical
<b>E8363A:</b>		
45 MHz to 500 MHz		-14 dBm, typical
500 MHz to 2 GHz		-10 dBm, typical
2 GHz to 10 GHz		-10 dBm, typical
10 GHz to 20 GHz		-9.5 dBm, typical
20 GHz to 30 GHz		-14 dBm, typical
30 GHz to 40 GHz		-15.5 dBm, typical
<b>E8364A:</b>		
45 MHz to 500 MHz		- 14 dBm, typical
500 MHz to 2 GHz		- 10 dBm, typical
2 GHz to 10 GHz		- 10 dBm, typical
10 GHz to 20 GHz		- 9.5 dBm, typical
20 GHz to 30 GHz		- 14 dBm, typical
30 GHz to 40 GHz		- 15.5 dBm, typical
40 GHz to 45 GHz		- 14 dBm, typical
45 GHz to 50 GHz		- 15 dBm, typical
<b>Damage Level</b>		
E8362A		+ 15 dBm, typical
E8363A		+ 15 dBm, typical
E8364A		+ 15 dBm, typical
<b>Maximum DC Level</b>		
E8362A		+/- 15 V, typical
E8363A		+/- 15 V, typical
E8364A		+/- 15 V, typical

**Table 48: Reference Outputs (Reference 1 Source Out, Reference 2 Source Out)**

<b>Description</b>	<b>Specification</b>	<b>Supplemental Information</b>
<b>Maximum Output Level</b>		
<b>E8362A:</b>		
45 MHz to 500 MHz		-24 dBm, typical
500 MHz to 2 GHz		-23 dBm, typical
2 GHz to 10 GHz		-23 dBm, typical
10 GHz to 20 GHz		-26 dBm, typical
<b>E8363A:</b>		
45 MHz to 500 MHz		-11.5 dBm, typical
500 MHz to 2 GHz		-10.5 dBm, typical
2 GHz to 10 GHz		-11 dBm, typical
10 GHz to 20 GHz		-11 dBm, typical
20 GHz to 30 GHz		-11 dBm, typical
30 GHz to 40 GHz		-11 dBm, typical
<b>E8364A:</b>		
45 MHz to 500 MHz		- 11.5 dBm, typical
500 MHz to 2 GHz		- 10.5 dBm, typical
2 GHz to 10 GHz		- 11 dBm, typical
10 GHz to 20 GHz		- 11 dBm, typical
20 GHz to 30 GHz		- 11 dBm, typical
30 GHz to 40 GHz		- 11 dBm, typical
40 GHz to 45 GHz		- 11 dBm, typical
45 GHz to 50 GHz		- 15 dBm, typical
<b>Damage Level</b>		
E8362A		+ 20 dBm, typical
E8363A		+ 20 dBm, typical
E8364A		+ 20 dBm, typical
<b>Maximum DC Level</b>		
E8362A		+/- 15 V, typical
E8363A		+/- 15 V, typical
E8364A		+/- 15 V, typical

Table 49: Source Outputs (Port 1 Source Out, Port 2 Source Out)

Description	Specification	Supplemental Information
<b>Maximum Output Level</b>		
<b>E8362A, Option 014:</b>		
45 MHz to 500 MHz		6 dBm, typical
500 MHz to 2 GHz		7 dBm, typical
2 GHz to 10 GHz		7 dBm, typical
10 GHz to 20 GHz		4 dBm, typical
<b>E8362A, Option 014 and UNL:</b>		
45 MHz to 500 MHz		4 dBm, typical
500 MHz to 2 GHz		5 dBm, typical
2 GHz to 10 GHz		5 dBm, typical
10 GHz to 20 GHz		2 dBm, typical
<b>E8363A, Option 014:</b>		
45 MHz to 500 MHz		5.5 dBm, typical
500 MHz to 2 GHz		6.5 dBm, typical
2 GHz to 10 GHz		6.5 dBm, typical
10 GHz to 20 GHz		4 dBm, typical
20 GHz to 30 GHz		1- dBm, typical
30 GHz to 40 GHz		-2 dBm, typical
<b>E8363A, Option 014 and UNL:</b>		
45 MHz to 500 MHz		3.5 dBm, typical
500 MHz to 2 GHz		5 dBm, typical
2 GHz to 10 GHz		5 dBm, typical
10 GHz to 20 GHz		3.5- dBm, typical
20 GHz to 30 GHz		0 dBm, typical
30 GHz to 40 GHz		-2.5 dBm, typical
<b>E8364A, Option 014:</b>		
45 MHz to 500 MHz		5.5 dBm, typical
500 MHz to 2 GHz		6.5 dBm, typical
2 GHz to 10 GHz		6.5 dBm, typical
10 GHz to 20 GHz		4 dBm, typical
20 GHz to 30 GHz		1 dBm, typical
30 GHz to 40 GHz		-2 dBm, typical
40 GHz to 45 GHz		-3 dBm, typical
45 GHz to 50 GHz		-7.5 dBm, typical
<b>E8364A, Option 014 and UNL:</b>		
45 MHz to 500 MHz		3.5 dBm, typical
500 MHz to 2 GHz		5 dBm, typical
2 GHz to 10 GHz		5 dBm, typical
10 GHz to 20 GHz		3.5 dBm, typical
20 GHz to 30 GHz		0 dBm, typical
30 GHz to 40 GHz		-2.5 dBm, typical
40 GHz to 45 GHz		-5 dBm, typical
45 GHz to 50 GHz		-10 dBm, typical

<b>Damage Level</b>		
E8362A		20 dBm, typical
E8363A		20 dBm, typical
E8364A		20 dBm, typical
<b>Maximum DC Level</b>		
E8362A		0 V, typical
E8363A		0 V, typical
E8364A		0 V, typical

**Table 50: Coupler Inputs (Port 1 Cplr Thru, Port 2 Cplr Thru)**

<b>Description</b>	<b>Specification</b>	<b>Supplemental Information</b>
<b>Insertion Loss to Test Port</b>		
<b>E8362A, Option 014:</b>		
45 MHz to 500 MHz		0.5 dB, typical
500 MHz to 2 GHz		1.5 dB, typical
2 GHz to 10 GHz		1.5 dB, typical
10 GHz to 20 GHz		1.5 dB, typical
<b>E8362A, Option 014 and UNL:</b>		
45 MHz to 500 MHz		1 dB, typical
500 MHz to 2 GHz		2 dB, typical
2 GHz to 10 GHz		2 dB, typical
10 GHz to 20 GHz		2 dB, typical
<b>E8363A, Option 014:</b>		
45 MHz to 500 MHz		0.5 dB, typical
500 MHz to 2 GHz		0.5 dB, typical
2 GHz to 10 GHz		1.5 dB, typical
10 GHz to 20 GHz		2 dB, typical
20 GHz to 30 GHz		3 dB, typical
30 GHz to 40 GHz		3.5 dB, typical
<b>E8363A, Option 014 and UNL:</b>		
45 MHz to 500 MHz		0.5 dB, typical
500 MHz to 2 GHz		1 dB, typical
2 GHz to 10 GHz		2 dB, typical
10 GHz to 20 GHz		3 dB, typical
20 GHz to 30 GHz		4 dB, typical
30 GHz to 40 GHz		5 dB, typical
<b>E8364A, Option 014:</b>		
45 MHz to 500 MHz		0.5 dB, typical
500 MHz to 2 GHz		0.5 dB, typical
2 GHz to 10 GHz		1.5 dB, typical
10 GHz to 20 GHz		2 dB, typical
20 GHz to 30 GHz		3 dB, typical
30 GHz to 40 GHz		3.5 dB, typical
40 GHz to 45 GHz		3.5 dB, typical
45 GHz to 50 GHz		4 dB, typical



<b>E8364A, Option 014 and UNL:</b>		
45 MHz to 500 MHz		0.5 dB, typical
500 MHz to 2 GHz		1 dB, typical
2 GHz to 10 GHz		2 dB, typical
10 GHz to 20 GHz		3 dB, typical
20 GHz to 30 GHz		4 dB, typical
30 GHz to 40 GHz		5 dB, typical
40 GHz to 45 GHz		5.5 dB, typical
45 GHz to 50 GHz		6 dB, typical
<b>Damage Level</b>		
E8362A		+ 30 dBm, typical
E8363A		+ 30 dBm, typical
E8364A		+ 30 dBm, typical
<b>Maximum DC Level</b>		
E8362A		+/- 40 V, typical
E8363A		+/- 40 V, typical
E8364A		+/- 40 V, typical

**Table 51: Coupler Outputs (Port 1 Cplr Arm, Port 2 Cplr Arm)**

<b>Description</b>	<b>Specification</b>	<b>Supplemental Information</b>
<b>Damage Level</b>		
E8362A		+ 30 dBm, typical
E8363A		+ 30 dBm, typical
E8364A		+ 30 dBm, typical
<b>Maximum DC Level</b>		
E8362A		+/- 7 V, typical
E8363A		+/- 7 V, typical
E8364A		+/- 7 V, typical

Test Set Block Diagrams

E836xA Standard Configuration and Standard Power Range

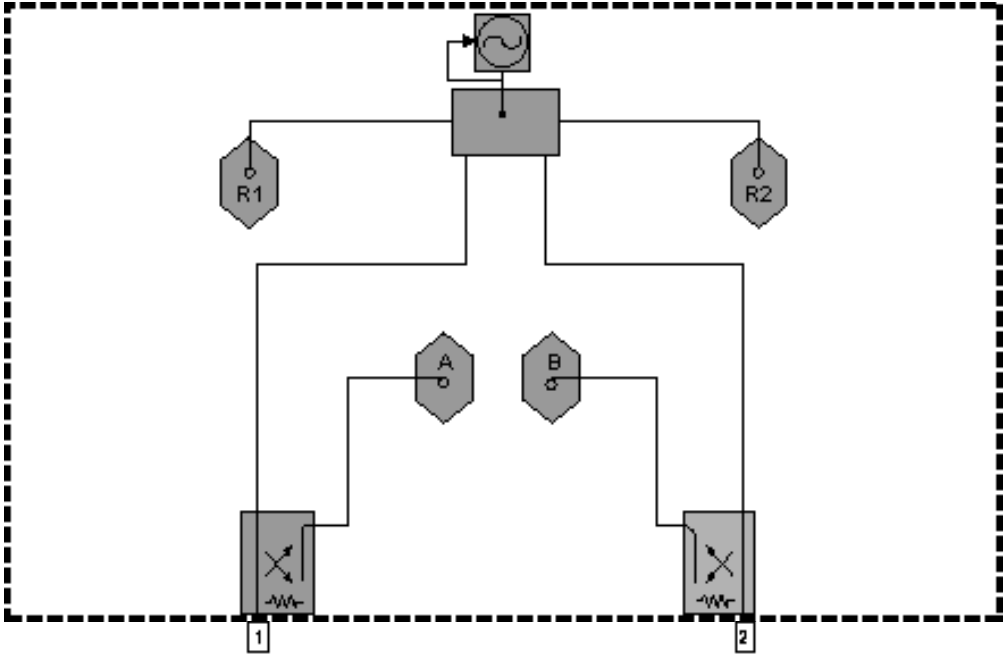

E836xA - Option UNL Standard Configuration with Extended Power Range and Bias - Tees

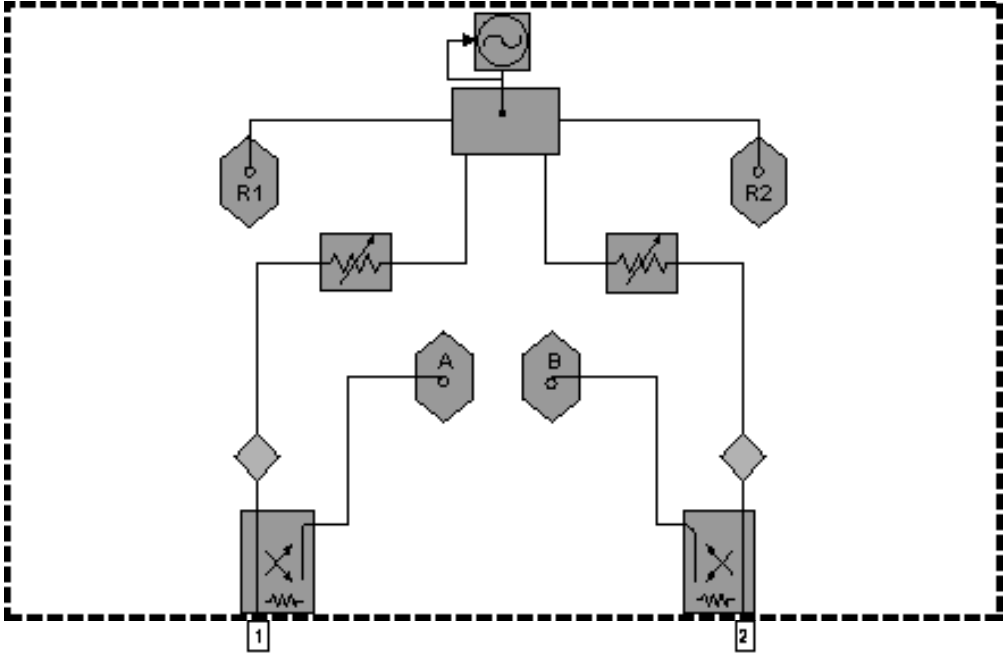

## Test Set with Option 014 Block Diagrams

### E836xA - Option 014 Extended Configuration and Standard Power Range

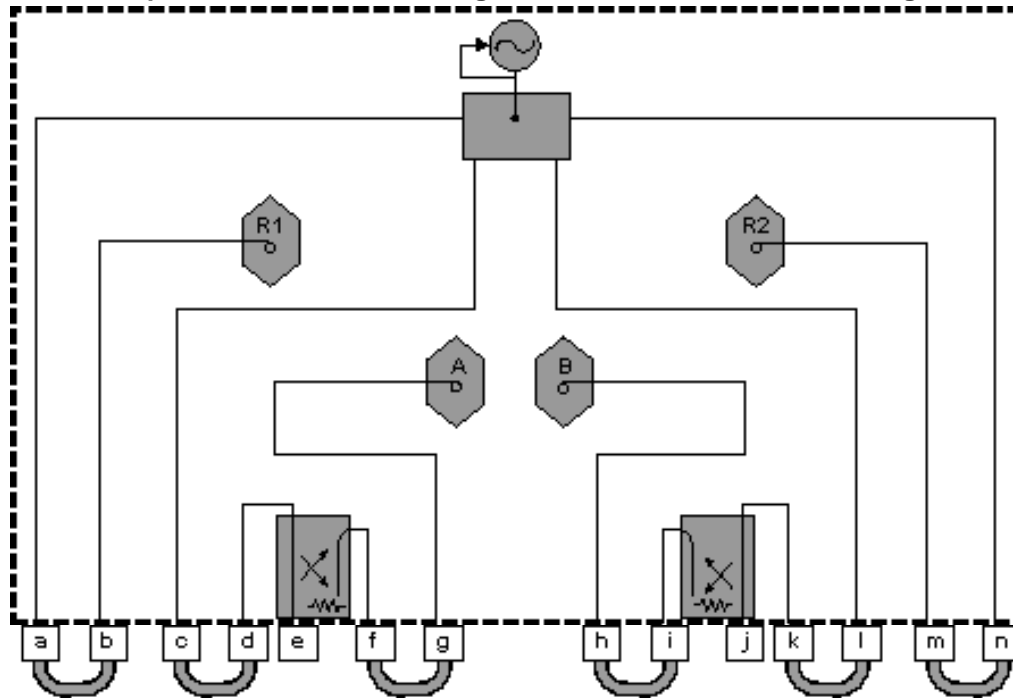

Item	Description	Item	Description
a	SOURCE OUT	h	RCVR B IN
b	RCVR R1 IN	i	CPLR ARM
c	SOURCE OUT	j	PORT 2
d	CPLR THRU	k	CPLR THRU
e	PORT 1	l	SOURCE OUT
f	CPLR ARM	m	RCVR R2 IN
g	RCVR A IN	n	SOURCE OUT

E836xA - Option UNL&014 Extended Configuration with Extended Power Range and Bias - Tees

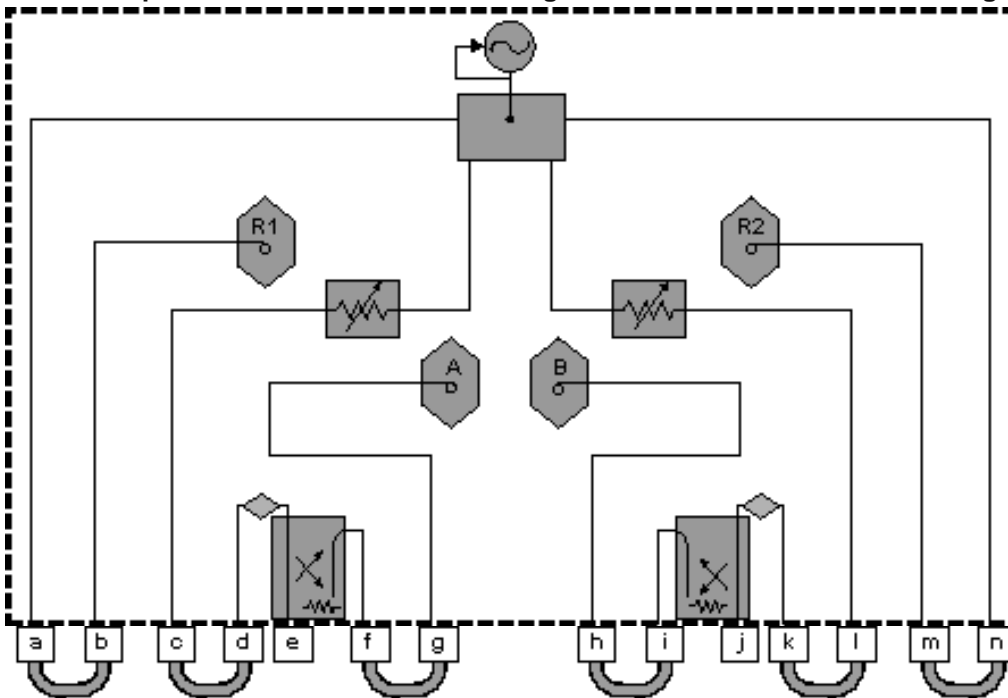

Item	Description	Item	Description
a	SOURCE OUT	h	RCVR B IN
b	RCVR R1 IN	i	CPLR ARM
c	SOURCE OUT	j	PORT 2
d	CPLR THRU	k	CPLR THRU
e	PORT 1	l	SOURCE OUT
f	CPLR ARM	m	RCVR R2 IN
g	RCVR A IN	n	SOURCE OUT

## 5 Technical Specifications for the E836xB

<b>Definitions</b> .....	5-4
<b>Corrected System Performance</b> .....	5-5
<b>Table 1.</b> System Dynamic Range <sup>a</sup> .....	5-5
<b>Table 2.</b> Receiver Dynamic Range <sup>a</sup> .....	5-7
<b>E8363/4B Corrected System Performance with 2.4mm Connectors</b> .....	5-8
<b>Table 3.</b> 85056A Calibration Kit Standard Configuration and Standard Power Range (E8363/4B).....	5-8
<b>Table 4.</b> 85056A Calibration Kit Fully Optioned Configurable Test Set, Extended Power Range & Bias-Tees, Receiver Attenuators, Frequency Offset Mode, and Reference Channel Transfer Switch (E836xB - Option 014, UNL, 016, 080, and 081).....	5-11
<b>Table 5.</b> 85056D Calibration Kit Standard Configuration and Standard Power Range (E8363/4B).....	5-14
<b>Table 6.</b> 85056D Calibration Kit Fully Optioned Configurable Test Set, Extended Power Range & Bias-Tees, Receiver Attenuators, Frequency Offset Mode, and Reference Channel Transfer Switch (E836xB - Option 014, UNL, 016, 080, and 081).....	5-17
<b>E8363/4B Corrected System Performance with 2.92mm Connectors</b> .....	5-20
<b>Table 7.</b> 85056K Calibration Kit Standard Configuration and Standard Power Range (E8363/4B).....	5-20
<b>Table 8.</b> 85056K Calibration Kit Fully Optioned Configurable Test Set, Extended Power Range & Bias-Tees, Receiver Attenuators, Frequency Offset Mode, and Reference Channel Transfer Switch (E836xB - Option 014, UNL, 016, 080, and 081).....	5-23
<b>E836xB Corrected System Performance with 3.5mm Connectors</b> .....	5-26
<b>Table 9.</b> 85052B Calibration Kit Standard Configuration and Standard Power Range (E836xB).....	5-26
<b>Table 10.</b> 85052B Calibration Kit Fully Optioned Configurable Test Set, Extended Power Range & Bias-Tees, Receiver Attenuators, Frequency Offset Mode, and Reference Channel Transfer Switch (E836xB - Option 014, UNL, 016, 080, and 081).....	5-29
<b>Table 11.</b> 85052C Calibration Kit Standard Configuration and Standard Power Range (E836xB).....	5-32
<b>Table 12.</b> 85052C Calibration Kit Fully Optioned Configurable Test Set, Extended Power Range & Bias-Tees, Receiver Attenuators, Frequency Offset Mode, and Reference Channel Transfer Switch (E836xB - Option 014, UNL, 016, 080, and 081).....	5-35
<b>Table 13.</b> 85052D Calibration Kit Standard Configuration and Standard Power Range (E836xB).....	5-38
<b>Table 14.</b> 85052D Calibration Kit Fully Optioned Configurable Test Set, Extended Power Range & Bias-Tees, Receiver Attenuators, Frequency Offset Mode, and Reference Channel Transfer Switch (E836xB - Option 014, UNL, 016, 080, and 081).....	5-41
<b>E836xB Corrected System Performance with 7mm Connectors</b> .....	5-44
<b>Table 15.</b> 85050B Calibration Kit Standard Configuration and Standard Power Range (E836xB).....	5-44
<b>Table 16.</b> 85050B Calibration Kit Fully Optioned Configurable Test Set, Extended Power Range & Bias-Tees, Receiver Attenuators, Frequency Offset Mode, and Reference Channel Transfer Switch (E836xB - Option 014, UNL, 016, 080, and 081).....	5-47
<b>Table 17.</b> 85050C Calibration Kit Standard Configuration and Standard Power Range (E836xB).....	5-50
<b>Table 18.</b> 85050C Calibration Kit Fully Optioned Configurable Test Set, Extended Power Range & Bias-Tees, Receiver Attenuators, Frequency Offset Mode, and Reference Channel Transfer Switch (E836xB - Option 014, UNL, 016, 080, and 081).....	5-53
<b>Table 19.</b> 85050D Calibration Kit Standard Configuration and Standard Power Range (E836xB).....	5-56
<b>Table 20.</b> 85050D Calibration Kit Fully Optioned *Configurable Test Set, Extended Power Range & Bias-Tees, Receiver Attenuators, Frequency Offset Mode, and Reference Channel Transfer Switch (E836xB - Option 014, UNL, 016, 080, and 081).....	5-59
<b>E836xB Corrected System Performance with Type-N Connectors</b> .....	5-62
<b>Table 21.</b> 85054B Calibration Kit Standard Configuration and Standard Power Range (E836xB).....	5-62
<b>Table 22.</b> 85054B Calibration Kit Fully Optioned Configurable Test Set, Extended Power Range & Bias-Tees, Receiver Attenuators, Frequency Offset Mode, and Reference Channel Transfer Switch (E836xB - Option 014, UNL, 016, 080, and 081).....	5-65
<b>Table 23.</b> 85054D Calibration Kit Standard Configuration and Standard Power Range (E836xB).....	5-68

Table 24. 85054D Calibration Kit Fully Optioned Configurable Test Set, Extended Power Range & Bias-Tees, Receiver Attenuators, Frequency Offset Mode, and Reference Channel Transfer Switch (E836xB - Option 014, UNL, 016, 080, and 081).....	5-71
<b>E8363/4B Corrected System Performance with WR-28 Connectors</b> .....	5-74
Table 25. R11644A Calibration Kit Standard Configuration and Standard Power Range (E8363/4B) .....	5-74
Table 26. R11644A Calibration Kit Fully Optioned Configurable Test Set, Extended Power Range & Bias-Tees, Receiver Attenuators, Frequency Offset Mode, and Reference Channel Transfer Switch (E836xB - Option 014, UNL, 016, 080, and 081).....	5-77
<b>E8363/4B Corrected System Performance with WR-42 Connectors</b> .....	5-80
Table 27. K11644A Calibration Kit Standard Configuration and Standard Power Range (E8363/4B) .....	5-80
Table 28. K11644A Calibration Kit Fully Optioned Configurable Test Set, Extended Power Range & Bias-Tees, Receiver Attenuators, Frequency Offset Mode, and Reference Channel Transfer Switch (E836xB - Option 014, UNL, 016, 080, and 081).....	5-83
<b>E836xB Corrected System Performance with WR-62 Connectors</b> .....	5-86
Table 29. P11644A Calibration Kit Standard Configuration and Standard Power Range (E836xB).....	5-86
Table 30. P11644A Calibration Kit Fully Optioned Configurable Test Set, Extended Power Range & Bias-Tees, Receiver Attenuators, Frequency Offset Mode, and Reference Channel Transfer Switch (E836xB - Option 014, UNL, 016, 080, and 081).....	5-89
<b>E836xB Corrected System Performance with WR-90 Connectors</b> .....	5-92
Table 31. X11644A Calibration Kit Standard Configuration and Standard Power Range (E836xB) .....	5-92
Table 32. X11644A Calibration Kit Fully Optioned Configurable Test Set, Extended Power Range & Bias-Tees, Receiver Attenuators, Frequency Offset Mode, and Reference Channel Transfer Switch (E836xB - Option 014, UNL, 016, 080, and 081).....	5-95
Table 34. Test Port Output <sup>a</sup> .....	5-100
Table 35: Test Port Input .....	5-104
Table 36. Dynamic Accuracy (Specification <sup>a</sup> ) .....	5-111
Table 37. Test Port Input (Group Delay) <sup>a</sup> .....	5-115
<b>General Information</b> .....	5-116
Table 38. Miscellaneous Information .....	5-116
Table 39. Front Panel Information .....	5-116
Table 40. Rear Panel Information .....	5-117
Table 41. Analyzer Environment and Dimensions.....	5-118
<b>Measurement Throughput Summary</b> .....	5-119
Table 42 Typical Cycle Time <sup>a,b</sup> (ms) for Measurement Completion.....	5-119
Table 43. Cycle Time vs IF Bandwidth <sup>a</sup> .....	5-120
Table 44. Cycle Time vs Number of Points <sup>a</sup> .....	5-120
Table 45. Data Transfer Time (ms) <sup>a</sup> .....	5-121
<b>Specifications: Front-Panel Jumpers</b> .....	5-122
Table 46: Measurement Receiver Inputs (Rcvr A In, Rcvr B In) .....	5-122
Table 47: Reference Receiver Inputs (Rcvr R1, Rcvr R2) .....	5-124
Table 48: Reference Outputs (Reference 1 Source Out, Reference 2 Source Out).....	5-125
Table 49: Source Outputs (Port 1 Source Out, Port 2 Source Out).....	5-126
Table 50: Coupler Inputs (Port 1 Cplr Thru, Port 2 Cplr Thru) .....	5-127
Table 51: Coupler Outputs (Port 1 Cplr Arm, Port 2 Cplr Arm) .....	5-128
<b>Test Set Block Diagrams</b> .....	5-129
E836xB - Standard Configuration and Standard Power Range .....	5-129
E836xB - Option UNL Standard Configuration with Extended Power Range and Bias - Tees.....	5-129
E836xB - Option UNL Standard Configuration with Extended Power Range	

and Bias - Tees, and <b>Option 016</b> , Receiver Attenuators .....	5-130
<b>Test Set with Option 014 Block Diagrams</b> .....	5-131
<b>E836xB - Option 014</b> Configurable Test Set and Standard Power Range.....	5-131
<b>E836xB - Option 014</b> Configurable Test Set and Standard Power Range, and <b>Option 081</b> Reference Channel Transfer Switch.....	5-132
<b>E836xB - Option 014</b> Configurable Test Set, and <b>Option UNL</b> Extended Power Range and Bias - Tees .....	5-133
<b>E836xB - Option 014</b> Configurable Test Set, and <b>Option UNL</b> Extended Power Range and Bias - Tees, and <b>Option 081</b> Reference Channel Transfer Switch .....	5-134
<b>E836xB - Option 014</b> Configurable Test Set and <b>Option UNL</b> , Extended Power Range and Bias - Tees and <b>Option 016</b> Receiver Attenuators .....	5-135
<b>E836xB - Option 014</b> Configurable Test Set, and <b>Option UNL</b> Extended Power Range and Bias - Tees, and <b>Option 016</b> Receiver Attenuators, and <b>Option 081</b> Reference Channel Transfer Switch .....	5-136

This is a complete list of the E8362B, E8363B, and E8364B network analyzer technical specifications.

- To optimize viewing of uncertainty curves, click the Maximize button.
- To view or print the PNA Series Data Sheet (a condensed version of the specifications), visit our web site at <http://www.agilent.com/find/pna>, select your analyzer model, and click on the link for the data sheet.
- The uncertainty curves contained in this document apply only to the setup conditions listed. Please download our free Uncertainty Calculator from [http://www.agilent.com/find/na\\_calculator](http://www.agilent.com/find/na_calculator) to generate the curves for your PNA setup. View the [equations](#) used to generate the uncertainty curves.

---

## Definitions

All specifications and characteristics apply over a 25 °C ±5 °C range (unless otherwise stated) and 90 minutes after the instrument has been turned on.

**Specification (spec.):** Warranted performance. Specifications include guardbands to account for the expected statistical performance distribution, measurement uncertainties, and changes in performance due to environmental conditions.

**Characteristic (char.):** A performance parameter that the product is expected to meet before it leaves the factory, but that is not verified in the field and is not covered by the product warranty. A characteristic includes the same guardbands as a specification.

**Typical (typ.):** Expected performance of an average unit which does not include guardbands. It is not covered by the product warranty.

**Nominal (nom.):** A general, descriptive term that does not imply a level of performance. It is not covered by the product warranty.

**Calibration:** The process of measuring known standards to characterize a network analyzer's systematic (repeatable) errors.

**Corrected (residual):** Indicates performance after error correction (calibration). It is determined by the quality of calibration standards and how well "known" they are, plus system repeatability, stability, and noise.

**Uncorrected (raw):** Indicates instrument performance without error correction. The uncorrected performance affects the stability of a calibration.

**Standard:** When referring to the analyzer, this includes no options unless noted otherwise.



## Corrected System Performance

The specifications in this section apply for measurements made with the E836xB analyzer with the following conditions:

- 10 Hz IF bandwidth
- No averaging applied to data
- Isolation calibration with an averaging factor of 8

**Table 1.** System Dynamic Range<sup>a</sup>

Description	Specification (dB) at Test Port <sup>b</sup>	Typical (dB) at Direct Receiver Access Input <sup>c</sup>	Supplemental Information
<b>Dynamic Range (in a 10 Hz BW)</b>			
<b>Standard Configuration and Standard Power Range (E836xB - Standard)</b>			
10 MHz to 45 MHz <sup>d</sup>	79		
45 MHz to 500 MHz <sup>e</sup>	94	NA	
500 MHz to 2 GHz	119	NA	
2 GHz to 10 GHz	122	NA	
10 GHz to 20 GHz	123	NA	
20 GHz to 30 GHz	114	NA	
30 GHz to 40 GHz	110	NA	
40 GHz to 45 GHz	109	NA	
45 GHz to 50 GHz	104	NA	
<b>Configurable Test Set and Standard Power Range (E836xB - Option 014)</b>			
10 MHz to 45 MHz <sup>d</sup>	79	129	
45 MHz to 500 MHz <sup>e</sup>	94	132	
500 MHz to 2 GHz	119	138	
2 GHz to 10 GHz	122	137	
10 GHz to 20 GHz	121	136	
20 GHz to 30 GHz	111	123	Option 016 degrades performance by 2 dB.
30 GHz to 40 GHz	107	119	
40 GHz to 45 GHz	105	116	
45 GHz to 50 GHz	100	111	
<b>Standard Configuration and Extended Power Range &amp; Bias-Tees (E836xB - Option UNL)</b>			
10 MHz to 45 MHz <sup>d</sup>	79		
45 MHz to 500 MHz <sup>e</sup>	92	NA	
500 MHz to 2 GHz	117	NA	
2 GHz to 10 GHz	120	NA	
10 GHz to 20 GHz	121	NA	
20 GHz to 30 GHz	112	NA	
30 GHz to 40 GHz	108	NA	
40 GHz to 45 GHz	105	NA	
45 GHz to 50 GHz	99	NA	

<b>Configurable Test Set and Extended Power Range &amp; Bias-Tees (E836xB - Option 014/UNL)</b>			
10 MHz to 45 MHz <sup>d</sup>	79	129	
45 MHz to 500 MHz <sup>e</sup>	92	130	
500 MHz to 2 GHz	117	136	
2 GHz to 10 GHz	120	135	
10 GHz to 20 GHz	119	134	
20 GHz to 30 GHz	109	121	Option 016 degrades performance by 2 dB.
30 GHz to 40 GHz	105	117	
40 GHz to 45 GHz	101	112	
45 GHz to 50 GHz	95	106	

<sup>a</sup> The system dynamic range is calculated as the difference between the noise floor and the source maximum output power. The effective dynamic range must take measurement uncertainties and interfering signals into account.

<sup>b</sup> The test port system dynamic range is calculated as the difference between the test port noise floor and the source maximum output power. The effective dynamic range must take measurement uncertainties and interfering signals into account.

<sup>c</sup> The direct receiver access input system dynamic range is calculated as the difference between the receiver access input noise floor and the source maximum output power. The effective dynamic range must take measurement uncertainties and interfering signals into account. This set-up should only be used when the receiver input will never exceed its damage level. When the analyzer is in segment sweep mode, the analyzer can have predefined frequency segments which will output a higher power level when the extended dynamic range is required (i.e. devices with high insertion loss), and reduced power when receiver damage may occur (i.e. devices with low insertion loss). The extended range is only available in one-path transmission measurements.

<sup>d</sup> Typical performance.

<sup>e</sup> May be limited to 100 dB at particular frequencies below 500 MHz due to spurious receiver residuals. Methods are available to regain the full dynamic range.

**Table 2. Receiver Dynamic Range<sup>a</sup>**

Description	Specification (dB) at Test Port <sup>b</sup>	Typical (dB) at Direct Receiver Access Input <sup>c</sup>	
<b>Dynamic Range (in a 10 Hz BW)</b>			
<b>Standard Configuration and Standard Power Range (E836xB - Standard)</b>			
<b>OR</b>			
<b>Standard Configuration and Extended Power Range &amp; Bias Tees (E836xB - Option UNL)</b>			
10 MHz to 45 MHz <sup>d</sup>	82	NA	
45 MHz to 500 MHz <sup>e</sup>	94	NA	NA
500 MHz to 2 GHz	119	NA	
2 GHz to 10 GHz	122	NA	
10 GHz to 20 GHz	125	NA	
20 GHz to 30 GHz	114	NA	
30 GHz to 40 GHz	111	NA	
40 GHz to 50 GHz	111	NA	
<b>Configurable Test Set and Standard Power Range (E836xB - Option 014)</b>			
<b>OR</b>			
<b>Configurable Test Set and Extended Power Range &amp; Bias Tees (E836xB - Option 014/UNL)</b>			
10 MHz to 45 MHz <sup>d</sup>	82	132	
45 MHz to 500 MHz <sup>e</sup>	94	132	
500 MHz to 2 GHz	119	138	
2 GHz to 10 GHz	122	137	
10 GHz to 20 GHz	124	139	
20 GHz to 30 GHz	113	125	Option 016 degrades performance by 2 dB.
30 GHz to 40 GHz	110	122	
40 GHz to 50 GHz	109	120	

<sup>a</sup> The receiver dynamic range is calculated as the difference between the noise floor and the receiver maximum output power. The effective dynamic range must take measurement uncertainties and interfering signals into account.

<sup>b</sup> The test port receiver dynamic range is calculated as the difference between the test port noise floor and the receiver maximum input level. The effective dynamic range must take measurement uncertainties and interfering signals into account.

<sup>c</sup> The direct receiver access input receiver dynamic range is calculated as the difference between the direct receiver access input noise floor and the receiver maximum input level. The effective dynamic range must take measurement uncertainties and interfering signals into account. This set-up should only be used when the receiver input will never exceed its compression or damage level. When the analyzer is in segment sweep mode, the analyzer can have predefined frequency segments which will output a higher power level when the extended dynamic range is required (i.e. devices with high insertion loss), and reduced power when compression or receiver damage may occur (i.e. devices with low insertion loss). The extended range is only available in one-path transmission measurements.

<sup>d</sup> Typical performance.

<sup>e</sup> May be degraded by 10 dB at particular frequencies (multiples of 5 MHz) below 500 MHz due to spurious receiver residuals. Methods are available to regain the full dynamic range.

**Note:** This E836xB document provides technical specifications for the following calibration kits only: 85056A, 85056D, 85056K, 85052B, 85052C, 85052D, 85050B, 85050C, 85050D, 85054B, 85054D, K11644A, P11644A, R11644A, and the X11644A.

## E8363/4B Corrected System Performance with 2.4mm Connectors

**Table 3.** 85056A Calibration Kit  
Standard Configuration and Standard Power Range  
(E8363/4B)

Applies to the E8363/4B analyzers, 85056A (2.4mm) calibration kit, 85133F flexible test port cable set, and a full 2-port calibration. Also applies to the following condition:

Environmental temperature 23° ±3 °C, with < 1 °C deviation from calibration temperature

Description	Specification (dB)			
	45 MHz to 2 GHz	2 to 20 GHz	20 to 40 GHz	40 to 50 GHz
Directivity	42	42	38	36
Source Match	41	38	33	31
Load Match	42	42	37	35
Reflection Tracking	±0.001 +0.02/°C	±0.008 +0.02/°C	±0.020 +0.02/°C	±0.027 +0.03/°C
Transmission Tracking	±0.010 +0.02/°C	±0.049 +0.02/°C	±0.105 +0.02/°C	±0.170 +0.03/°C

## Transmission Uncertainty (Specifications)

### Magnitude

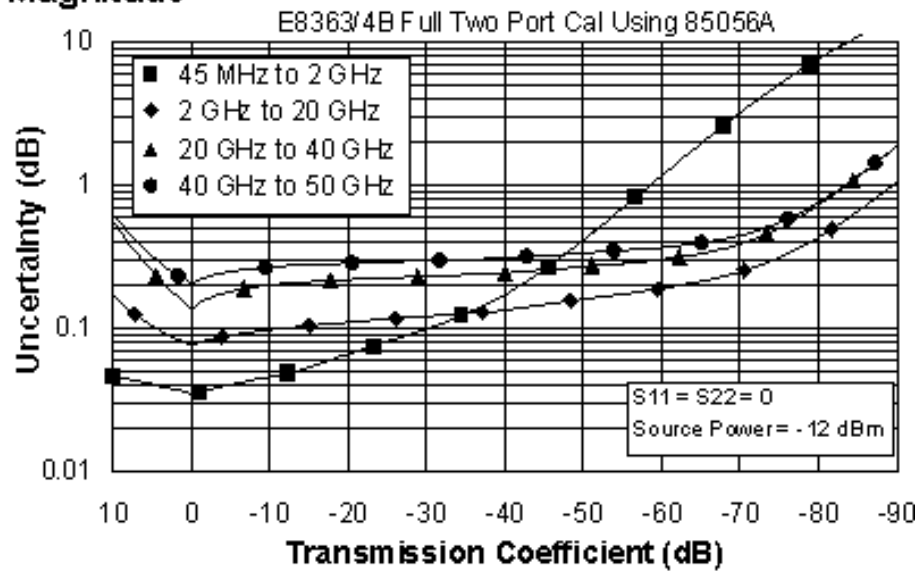

### Phase

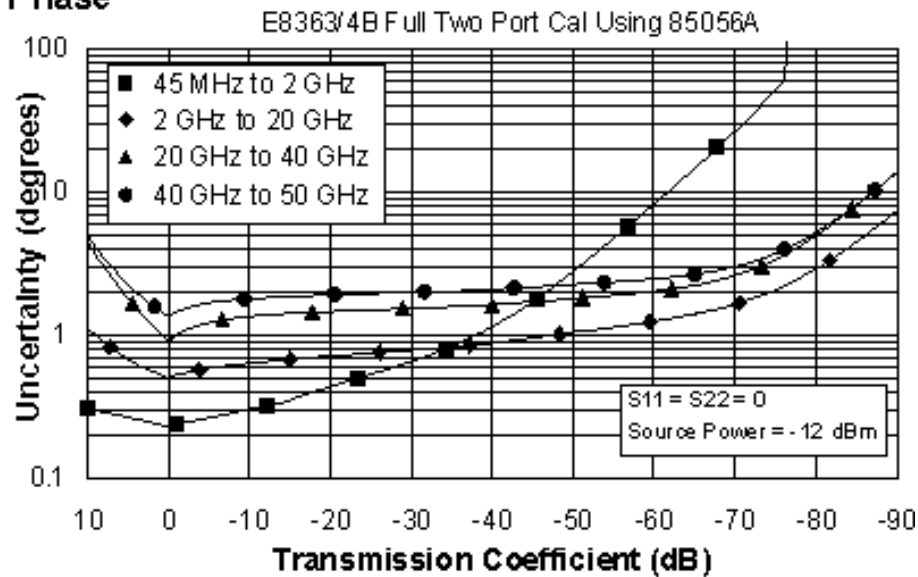

Reflection Uncertainty (Specifications)

Magnitude

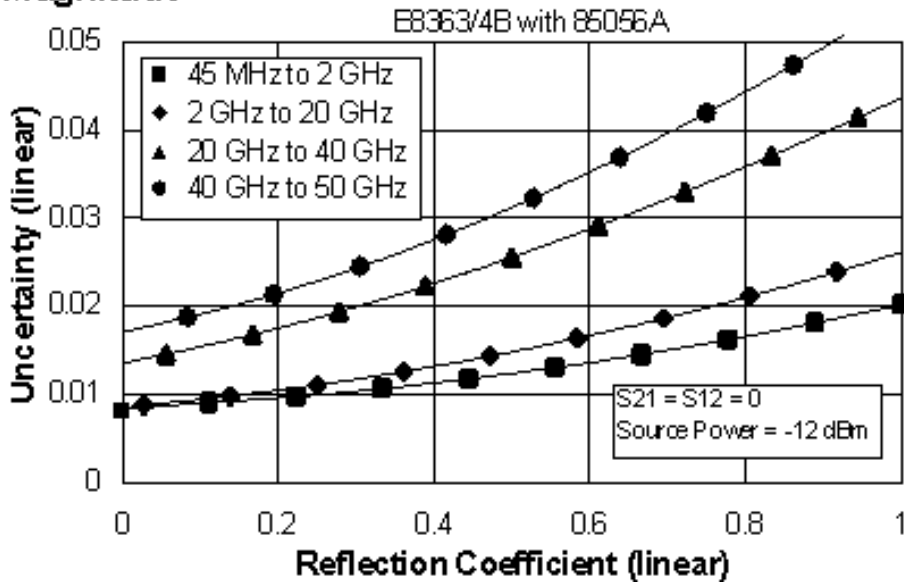

Phase

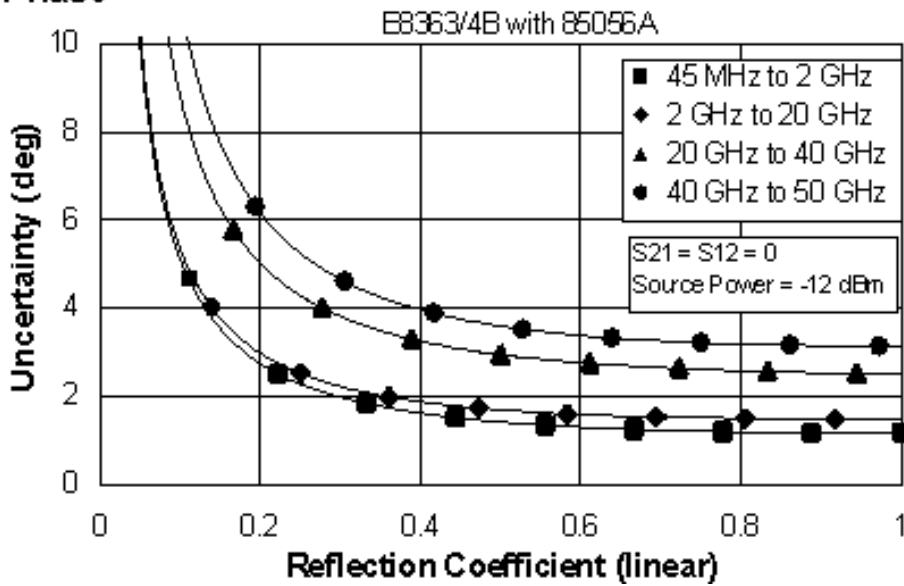

**Table 4.** 85056A Calibration Kit

Fully Optioned

Configurable Test Set, Extended Power Range & Bias-Tees, Receiver Attenuators, Frequency Offset Mode, and Reference Channel Transfer Switch

(E836xB - Option 014, UNL, 016, 080, and 081)

Applies to the, E8363/4B analyzers, 85056A (2.4mm) calibration kit, 85133F flexible test port cable set, and a full 2-port calibration. Also applies to the following condition:

Environmental temperature 23° ±3 °C, with < 1 °C deviation from calibration temperature

Description	Specification (dB)			
	45 MHz to 2 GHz	2 to 20 GHz	20 to 40 GHz	40 to 50 GHz
Directivity	42	42	38	36
Source Match	41	38	33	31
Load Match	42	42	37	35
Reflection Tracking	±0.001 +0.02/°C	±0.008 +0.02/°C	±0.020 +0.02/°C	±0.027 +0.03/°C
Transmission Tracking	±0.019 +0.02/°C	±0.053 +0.02/°C	±0.109 +0.02/°C	±0.182 +0.03/°C

## Transmission Uncertainty (Specifications)

### Magnitude

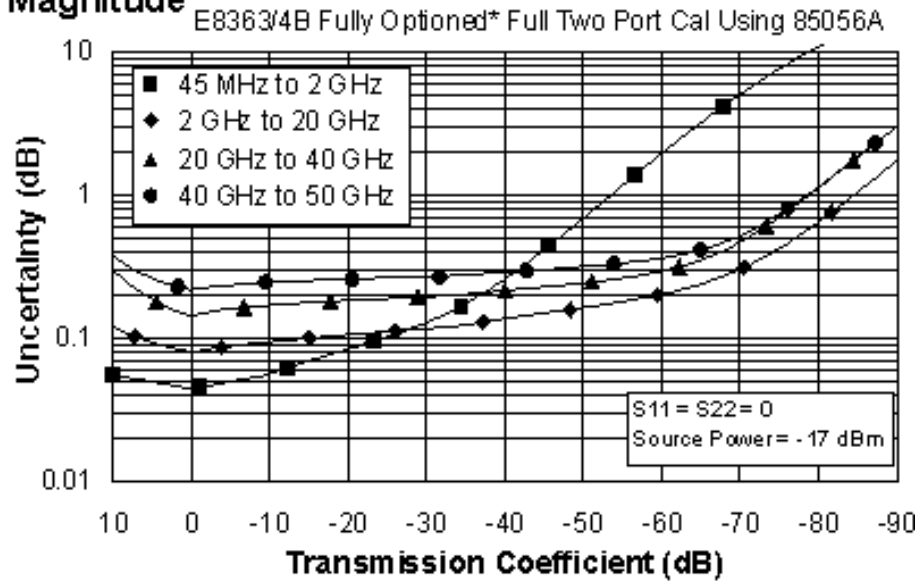

### Phase

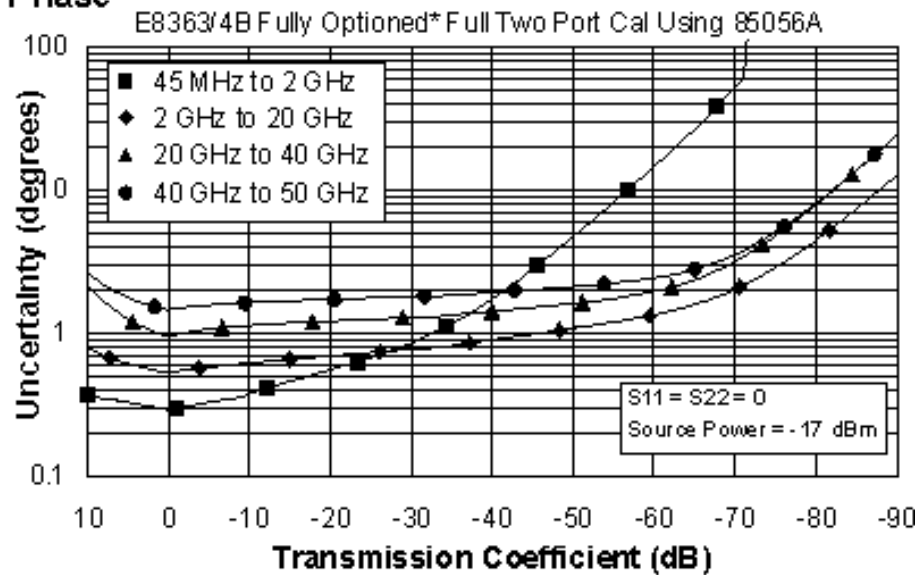

\* Configurable Test Set, Extended Power Range & Bias-Tees, Receiver Attenuators, Frequency Offset Mode, and Reference Channel Transfer Switch (E836xB - Option 014, UNL, 016, 080, and 081)



**Reflection Uncertainty (Specifications)**

**Magnitude**

E8363/4B Fully Optioned\* with 85066A

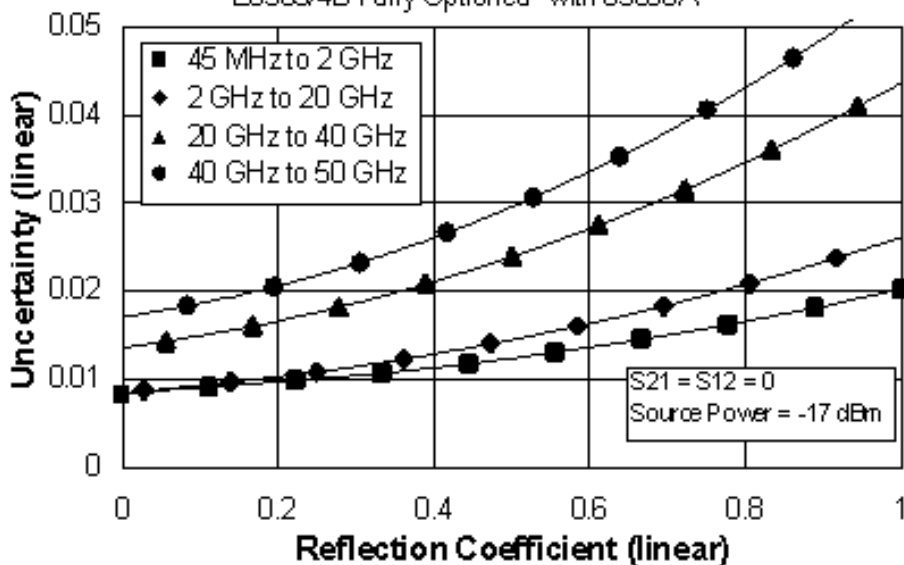

**Phase**

E8363/4B Fully Optioned\* with 85066A

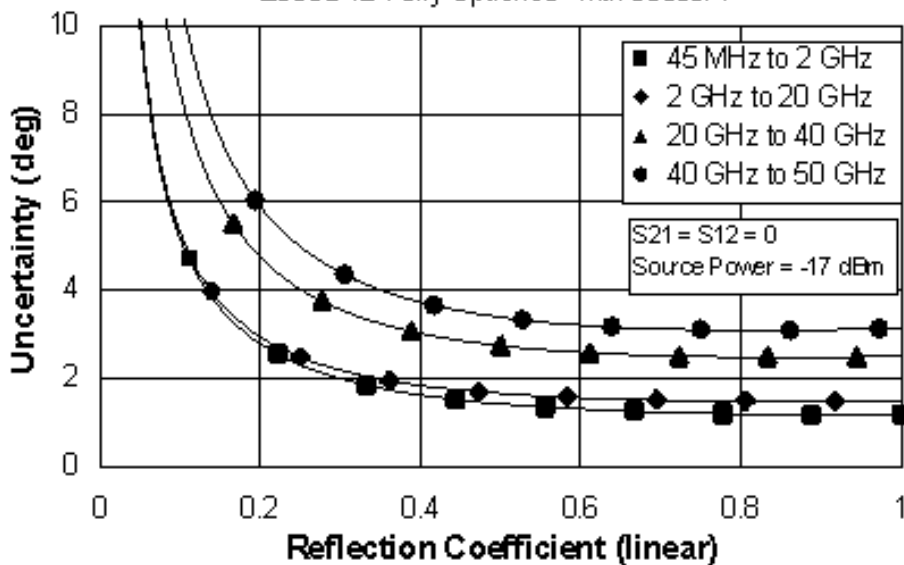

\* Configurable Test Set, Extended Power Range & Bias-Tees, Receiver Attenuators, Frequency Offset Mode, and Reference Channel Transfer Switch (E836xB - Option 014, UNL, 016, 080, and 081)

**Table 5.** 85056D Calibration Kit  
 Standard Configuration and Standard Power Range  
 (E8363/4B)

Applies to the, E8363/4B analyzers, 85056D (2.4mm) calibration kit, 85133F flexible test port cable set, and a full 2-port calibration. Also applies to the following condition:

Environmental temperature 23° ±3 °C, with < 1 °C deviation from calibration temperature

Description	Specification (dB)			
	45 MHz to 2 GHz	2 to 20 GHz	20 to 40 GHz	40 to 50 GHz
Directivity	42	34	26	26
Source Match	40	30	24	23
Load Match	42	33	25	25
Reflection Tracking	±0.002 +0.02/°C	±0.029 +0.02/°C	±0.079 +0.02/°C	±0.075 +0.03/°C
Transmission Tracking	±0.011 +0.02/°C	±0.121 +0.02/°C	±0.347 +0.02/°C	±0.462 +0.03/°C

## Transmission Uncertainty (Specifications)

### Magnitude

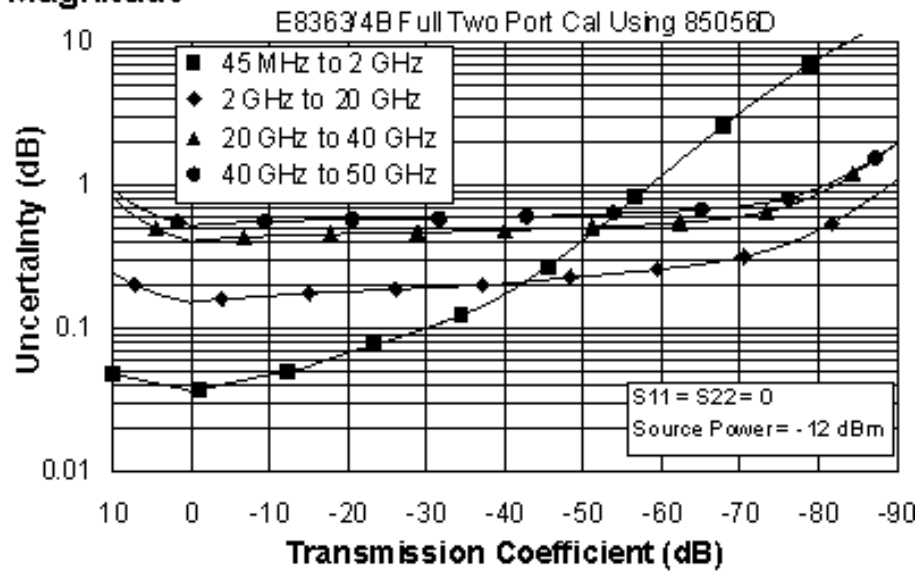

### Phase

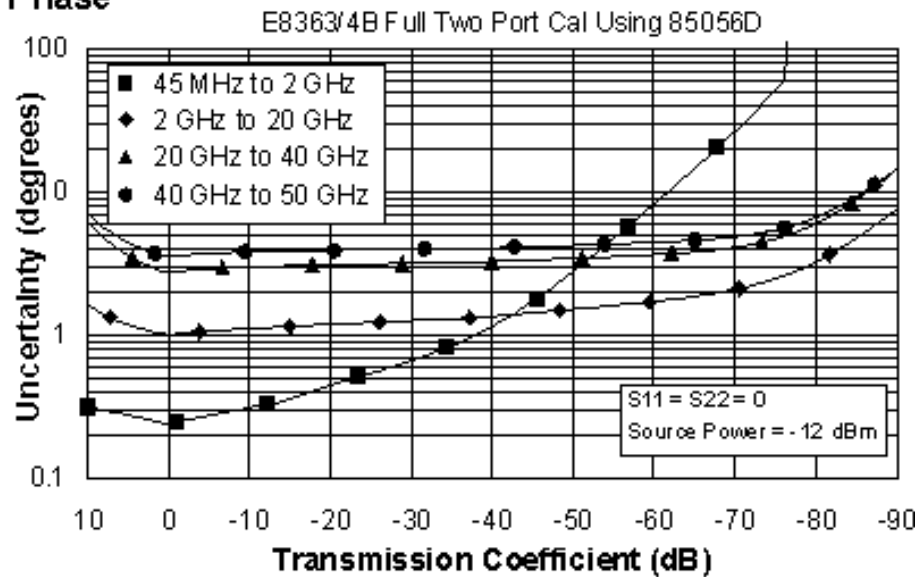

Reflection Uncertainty (Specifications)

Magnitude

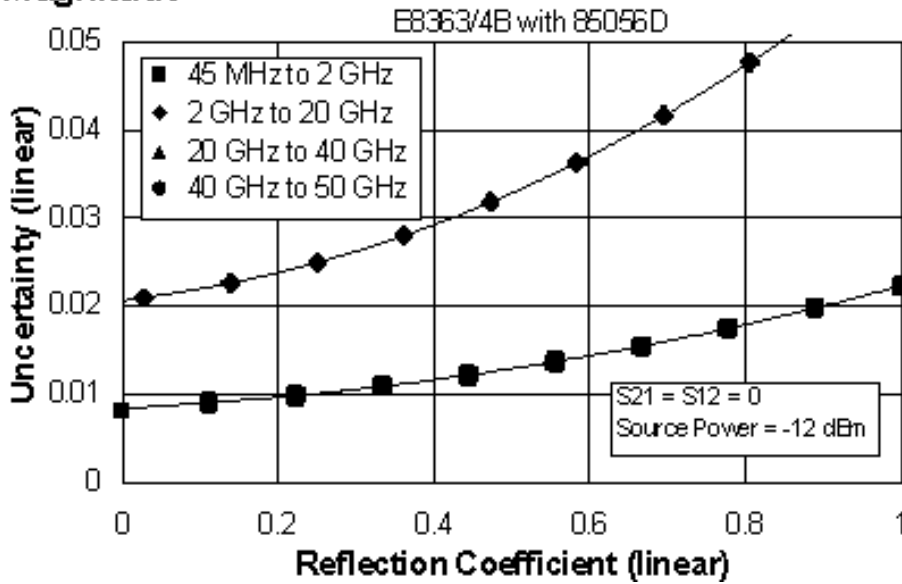

Phase

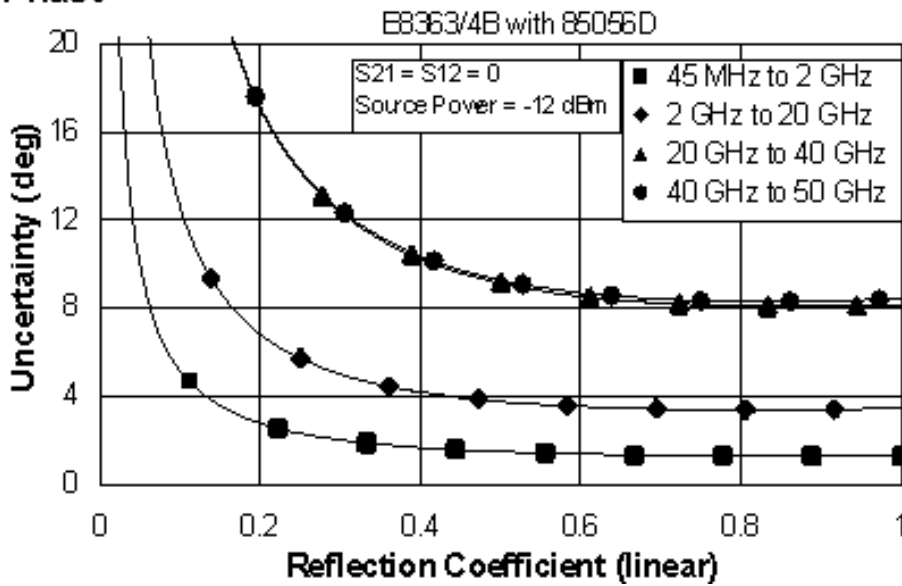

**Table 6.** 85056D Calibration Kit

Fully Optioned

Configurable Test Set, Extended Power Range & Bias-Tees, Receiver Attenuators, Frequency Offset Mode, and Reference Channel Transfer Switch

(E836xB - Option 014, UNL, 016, 080, and 081)

Applies to the, E8363/4B analyzers, 85056D (2.4mm) calibration kit, 85133F flexible test port cable set, and a full 2-port calibration. Also applies to the following condition:

Environmental temperature 23° ±3 °C, with < 1 °C deviation from calibration temperature

Description	Specification (dB)			
	45 MHz to 2 GHz	2 to 20 GHz	20 to 40 GHz	40 to 50 GHz
Directivity	42	34	26	26
Source Match	40	30	24	23
Load Match	42	33	25	25
Reflection Tracking	±0.002 +0.02/°C	±0.029 +0.02/°C	±0.079 +0.02/°C	±0.075 +0.03/°C
Transmission Tracking	±0.022 +0.02/°C	±0.130 +0.02/°C	±0.365 +0.02/°C	±0.498 +0.03/°C

**Transmission Uncertainty (Specifications)**

**Magnitude**

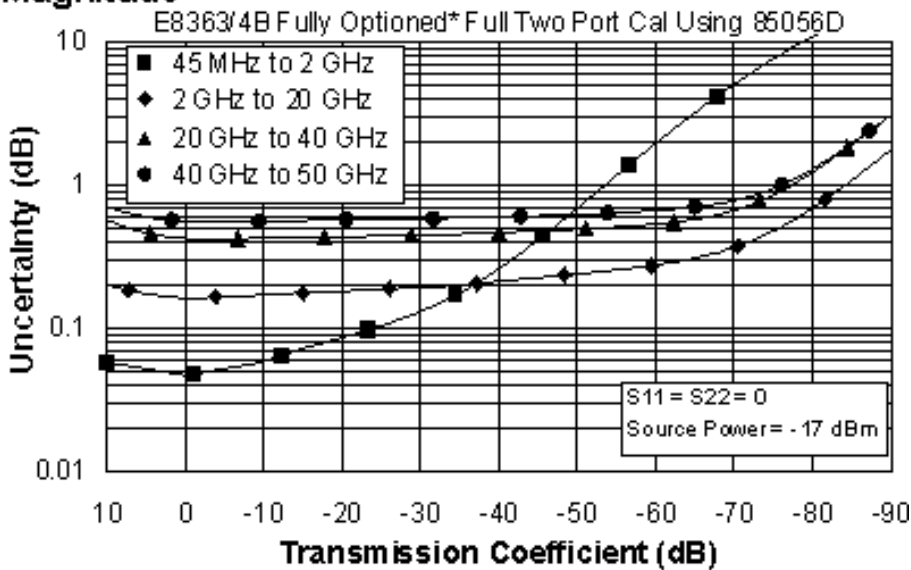

**Phase**

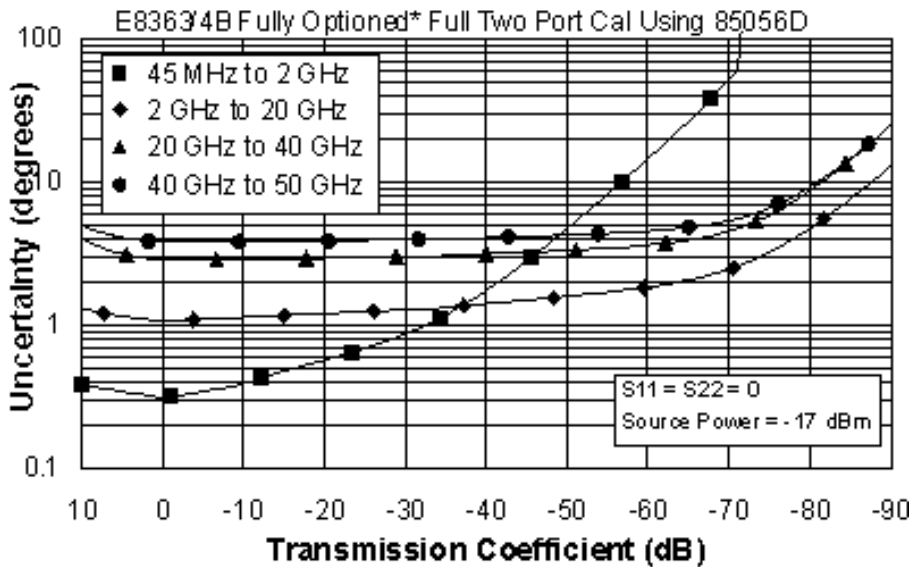

\* Configurable Test Set, Extended Power Range & Bias-Tees, Receiver Attenuators, Frequency Offset Mode, and Reference Channel Transfer Switch (E836xB - Option 014, UNL, 016, 080, and 081)

## Reflection Uncertainty (Specifications)

### Magnitude

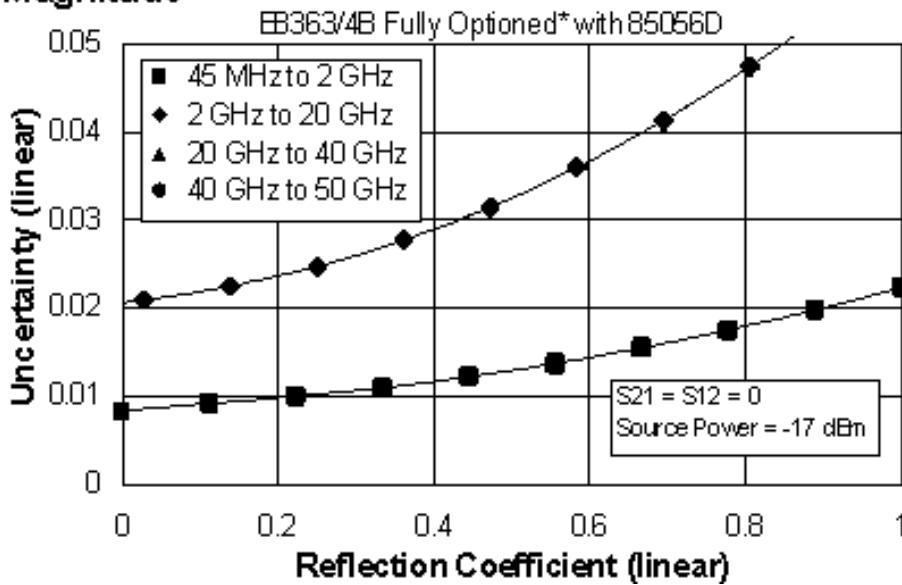

### Phase

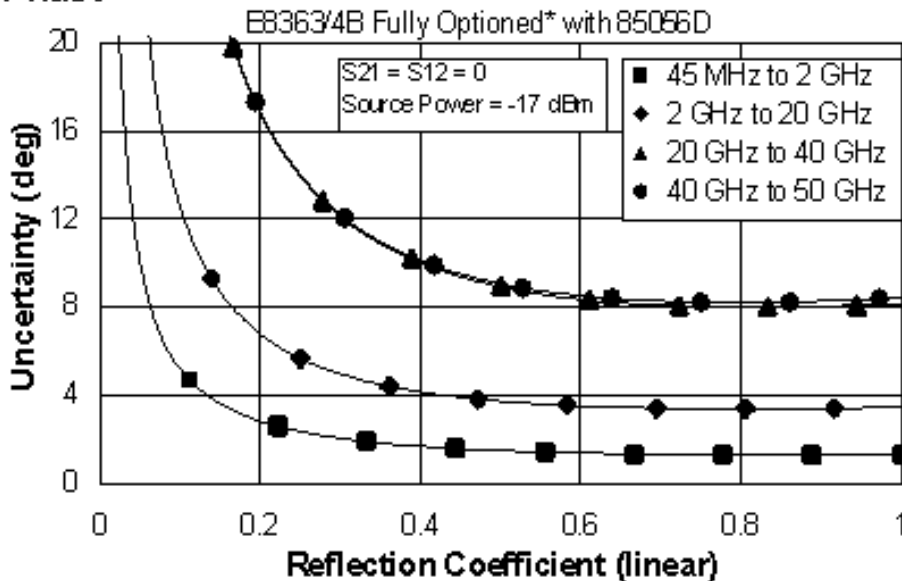

\* Configurable Test Set, Extended Power Range & Bias-Tees, Receiver Attenuators, Frequency Offset Mode, and Reference Channel Transfer Switch (E836xB - Option 014, UNL, 016, 080, and 081)

## E8363/4B Corrected System Performance with 2.92mm Connectors

### 85056K Calibration Kit:

**Table 7.** 85056K Calibration Kit  
Standard Configuration and Standard Power Range  
(E8363/4B)

Applies to the, E8363/4B analyzers, 85056K (2.92mm) calibration kit, 85133F flexible test port cable set, and a full 2-port calibration. Also applies to the following condition:

Environmental temperature 23° ±3 °C, with < 1 °C deviation from calibration temperature

Description	Specification (dB)		
	0.045 to 2 GHz	2 to 20 GHz	20 to 40 GHz
Directivity	42	42	40
Source Match	40	40	35
Load Match	42	41	38
Reflection Tracking	±0.018 +0.02/°C	±0.018 +0.02/°C	±0.067 +0.03/°C
Transmission Tracking	±0.011 +0.02/°C	±0.042 +0.02/°C	±0.089 +0.03/°C



## Transmission Uncertainty (Specifications)

### Magnitude

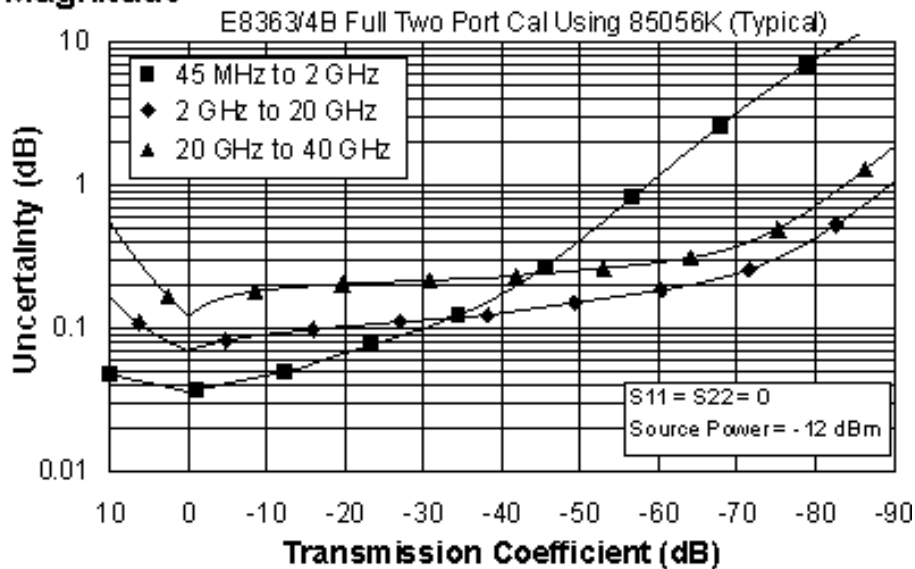

### Phase

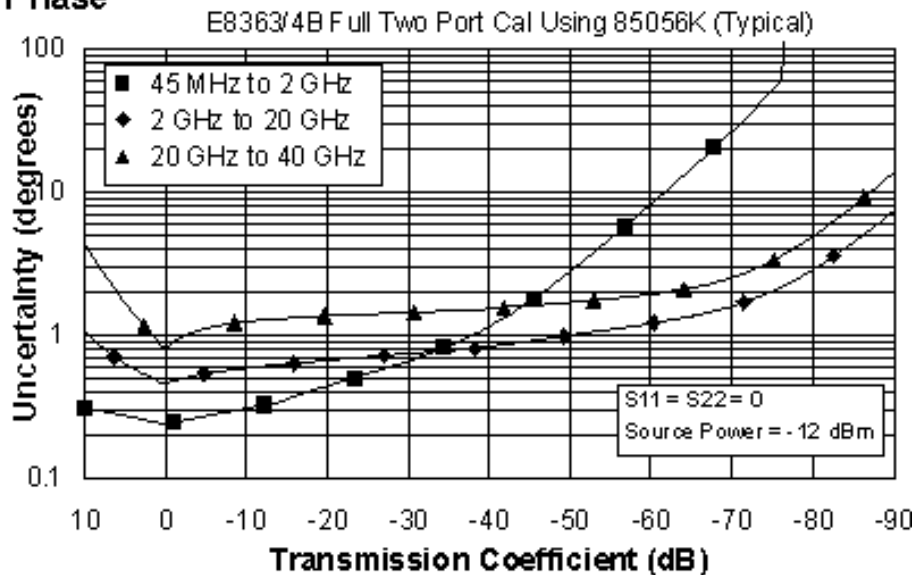

## Reflection Uncertainty (Specifications)

### Magnitude

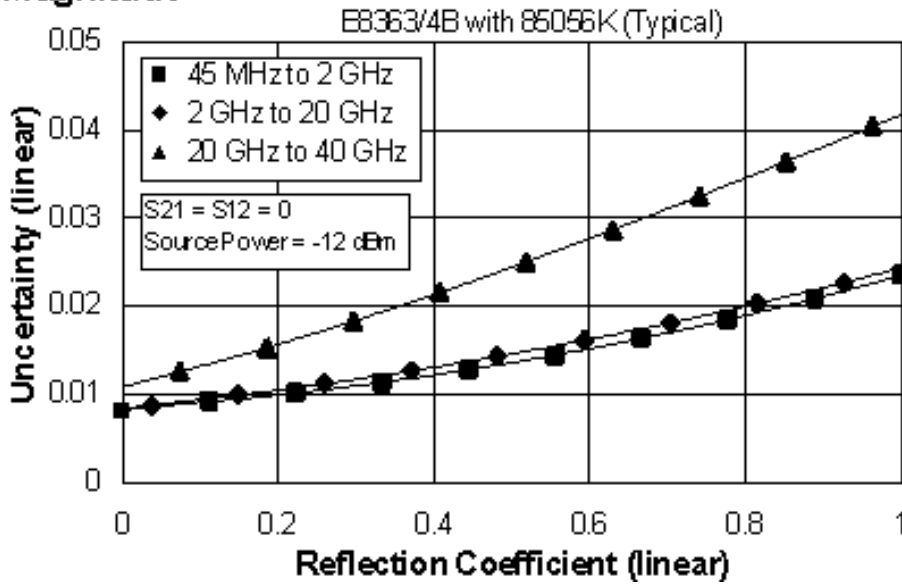

### Phase

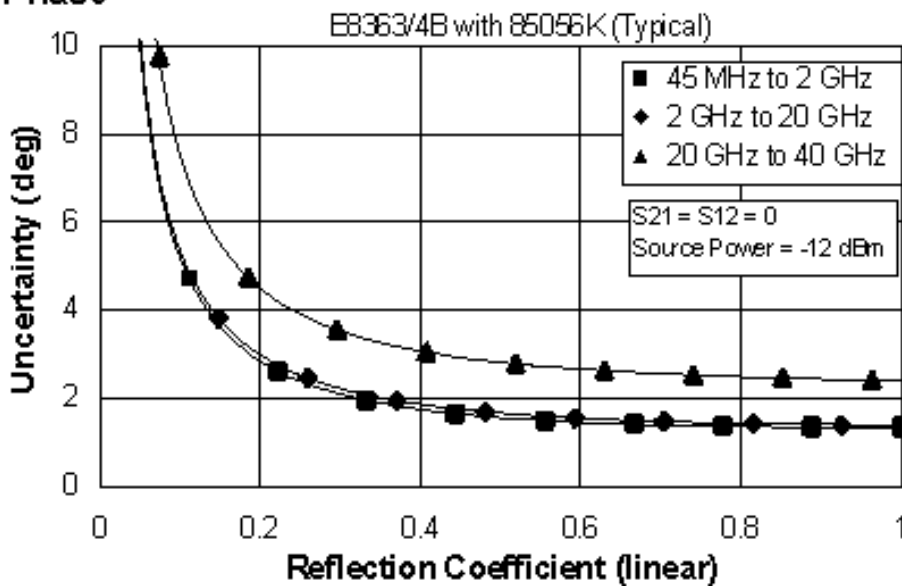

**Table 8.** 85056K Calibration Kit

Fully Optioned

Configurable Test Set, Extended Power Range & Bias-Tees, Receiver Attenuators, Frequency Offset Mode, and Reference Channel Transfer Switch

(E836xB - Option 014, UNL, 016, 080, and 081)

Applies to the, E8363/4B analyzers, 85056K (2.92mm) calibration kit, 85133F flexible test port cable set, and a full 2-port calibration. Also applies to the following condition:

Environmental temperature 23° ±3 °C, with < 1 °C deviation from calibration temperature

Description	Specification (dB)		
	0.045 to 2 GHz	2 to 20 GHz	20 to 40 GHz
Directivity	42	42	40
Source Match	40	40	35
Load Match	42	41	38
Reflection Tracking	±0.018 +0.02/°C	±0.018 +0.02/°C	±0.067 +0.03/°C
Transmission Tracking	±0.021 +0.02/°C	±0.046 +0.02/°C	±0.094 +0.03/°C

## Transmission Uncertainty (Specifications)

### Magnitude

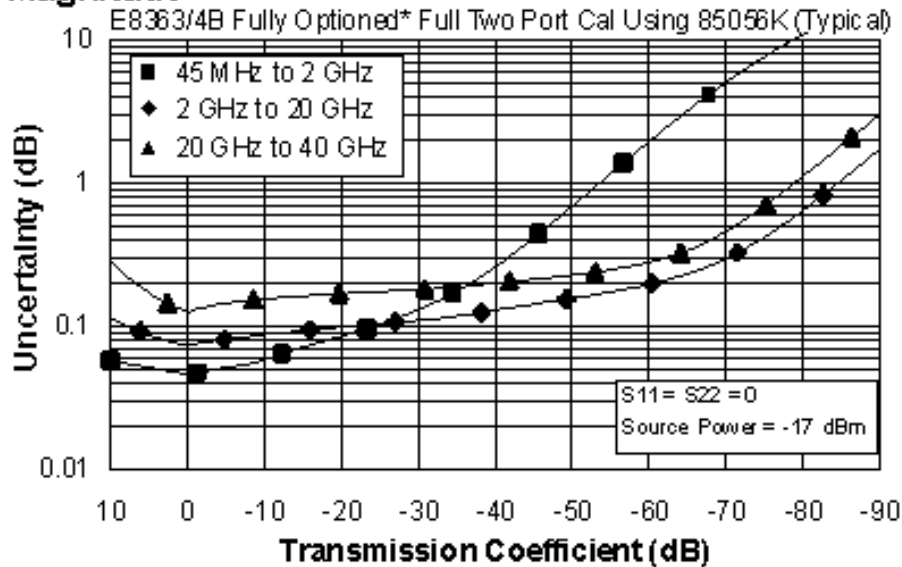

### Phase

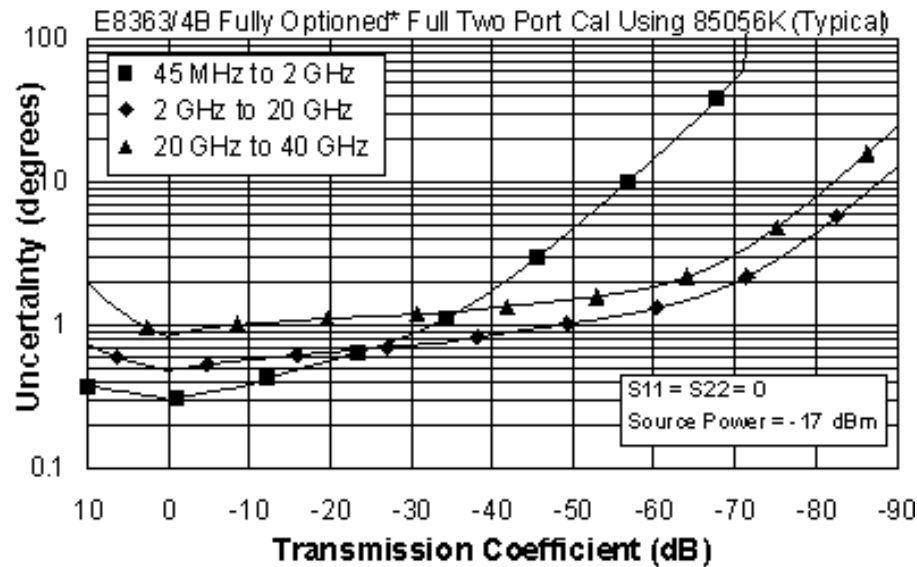

\* Configurable Test Set, Extended Power Range & Bias-Tees, Receiver Attenuators, Frequency Offset Mode, and Reference Channel Transfer Switch (E836xB - Option 014, UNL, 016, 080, and 081)

## Reflection Uncertainty (Specifications)

### Magnitude

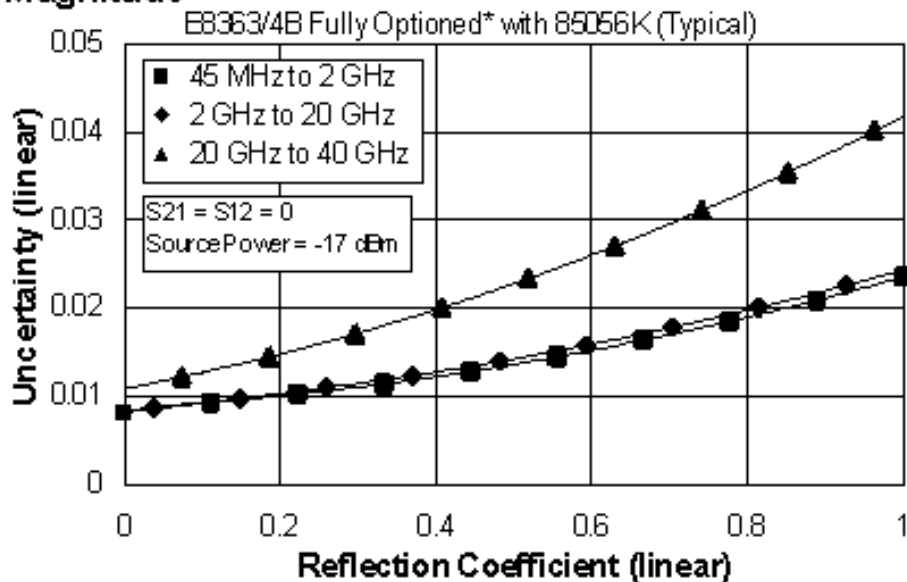

### Phase

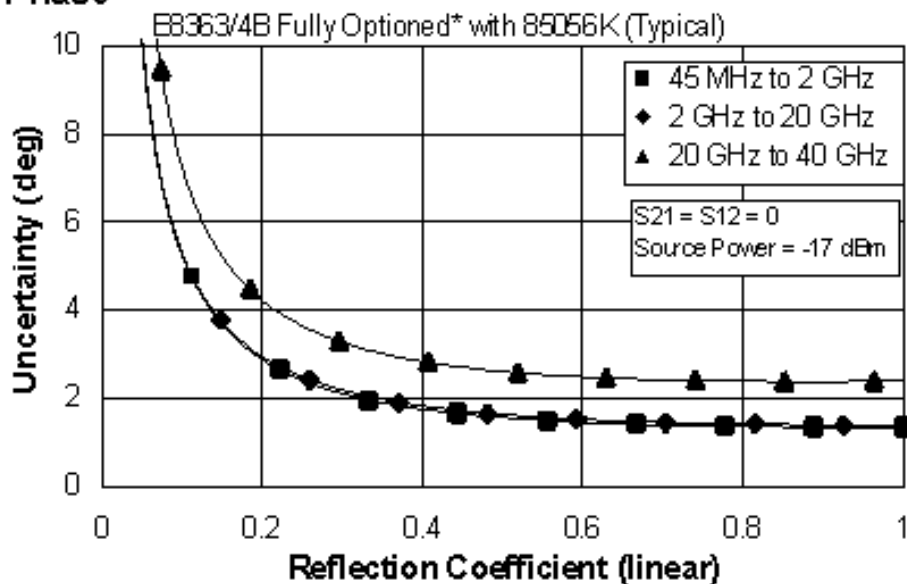

\* Configurable Test Set, Extended Power Range & Bias-Tees, Receiver Attenuators, Frequency Offset Mode, and Reference Channel Transfer Switch (E836xB - Option 014, UNL, 016, 080, and 081)

## E836xB Corrected System Performance with 3.5mm Connectors

**Table 9.** 85052B Calibration Kit  
Standard Configuration and Standard Power Range  
(E836xB)

Applies to the, E836xB analyzers, 85052B (3.5mm) calibration kit, 85131F flexible test port cable set, and a full 2-port calibration. Also applies to the following condition:

Environmental temperature 23° ±3 °C, with < 1 °C deviation from calibration temperature

Description	Specification (dB)		
	45 MHz to 2 GHz	2 to 20 GHz	20 to 26.5 GHz
Directivity	48	44	44
Source Match	40	31	31
Load Match	48	44	44
Reflection Tracking	±0.003 +0.02/°C	±0.006 +0.02/°C	±0.006 +0.03/°C
Transmission Tracking	±0.009 +0.02/°C	±0.088 +0.02/°C	±0.104 +0.03/°C

## Transmission Uncertainty (Specifications)

### Magnitude

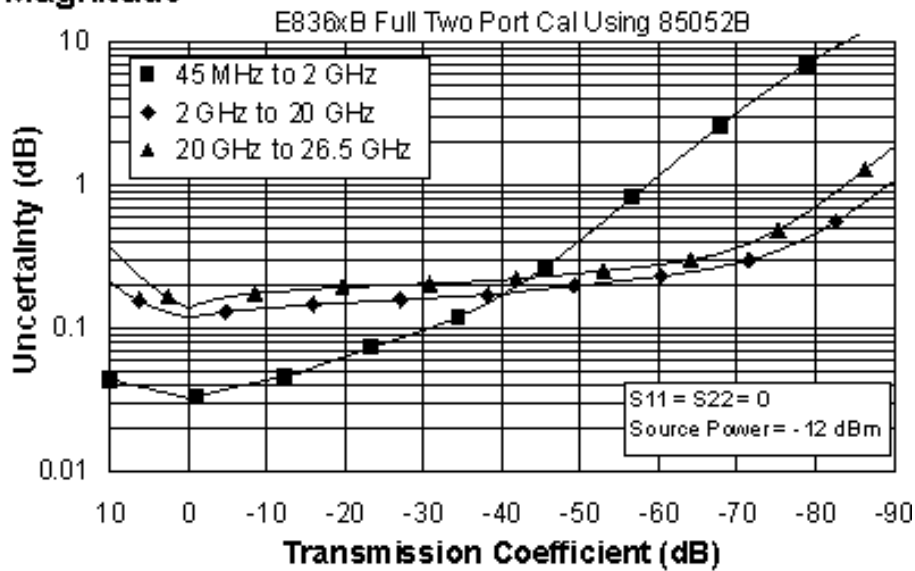

### Phase

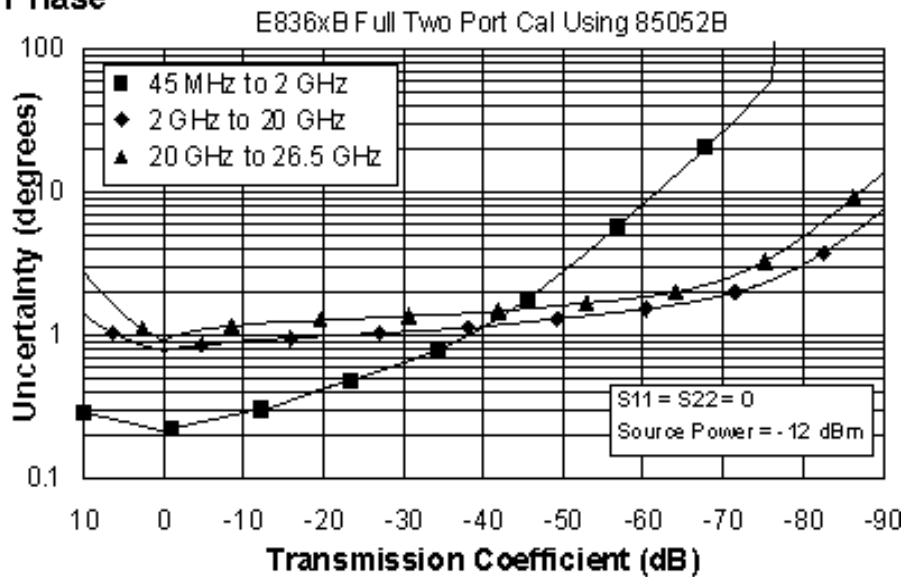

## Reflection Uncertainty (Specifications)

### Magnitude

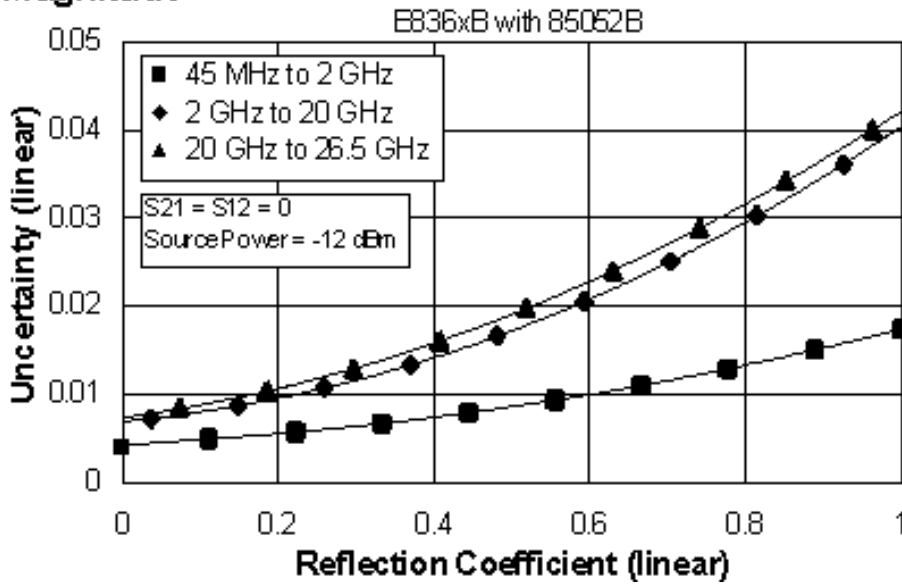

### Phase

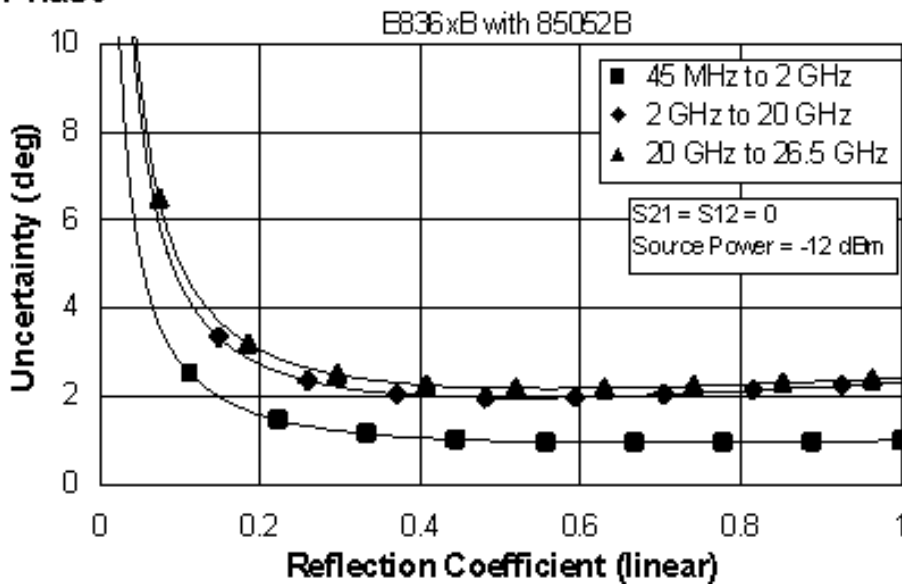



**Table 10.** 85052B Calibration Kit

Fully Optioned

Configurable Test Set, Extended Power Range & Bias-Tees, Receiver Attenuators, Frequency Offset Mode, and Reference Channel Transfer Switch

(E836xB - Option 014, UNL, 016, 080, and 081)

Applies to the, E836xB analyzers, 85052B (3.5mm) calibration kit, 85131F flexible test port cable set, and a full 2-port calibration. Also applies to the following condition:

Environmental temperature 23° ±3 °C, with < 1 °C deviation from calibration temperature

Description	Specification (dB)		
	45 MHz to 2 GHz	2 to 20 GHz	20 to 26.5 GHz
Directivity	48	44	44
Source Match	40	31	31
Load Match	48	44	44
Reflection Tracking	±0.003 +0.02/°C	±0.006 +0.02/°C	±0.006 +0.03/°C
Transmission Tracking	±0.017 +0.02/°C	±0.091 +0.02/°C	±0.106 +0.03/°C

## Transmission Uncertainty (Specifications)

### Magnitude

E836xB Fully Optioned\* Full Two Port Cal Using 85052B

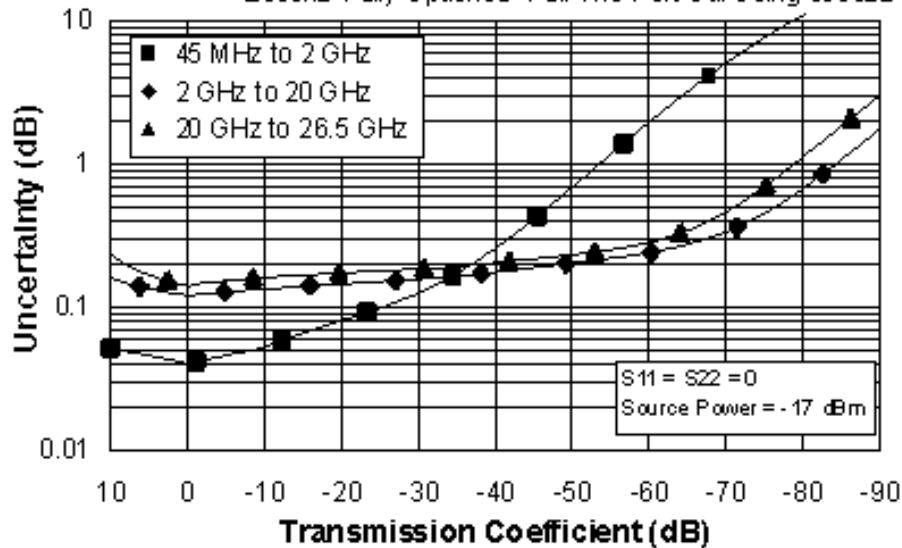

### Phase

E836xB Fully Optioned\* Full Two Port Cal Using 85052B

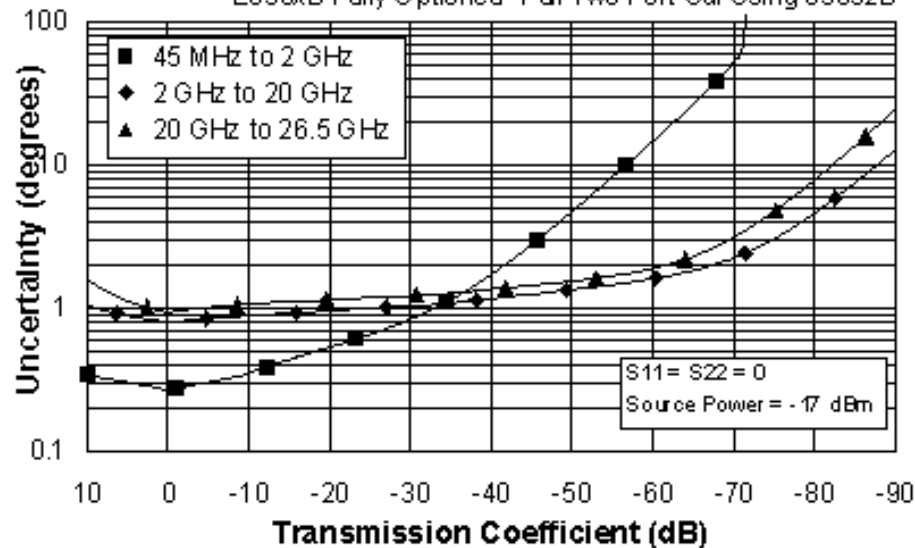

\* Configurable Test Set, Extended Power Range & Bias-Tees, Receiver Attenuators, Frequency Offset Mode, and Reference Channel Transfer Switch  
(E836xB - Option 014, UNL, 016, 080, and 081)

**Reflection Uncertainty (Specifications)**

**Magnitude**

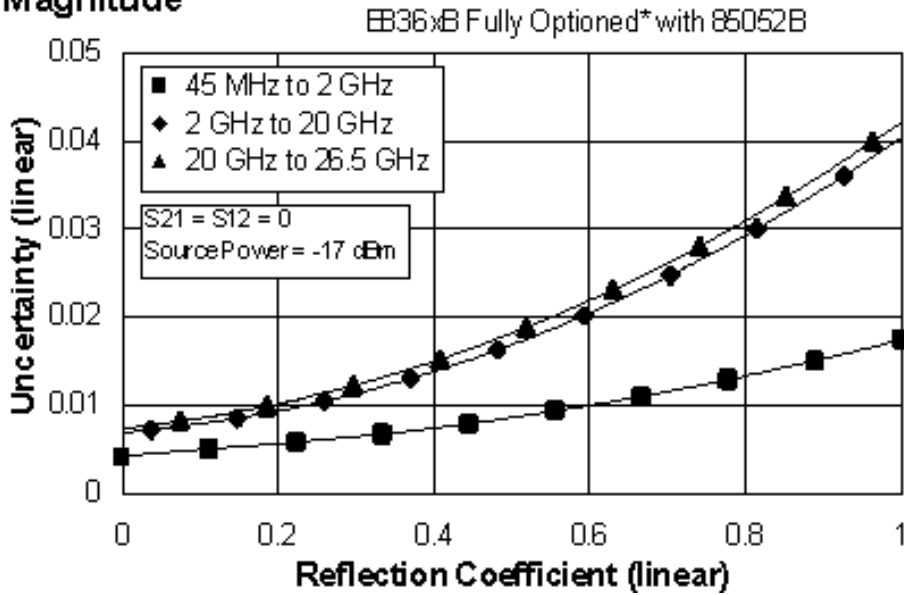

**Phase**

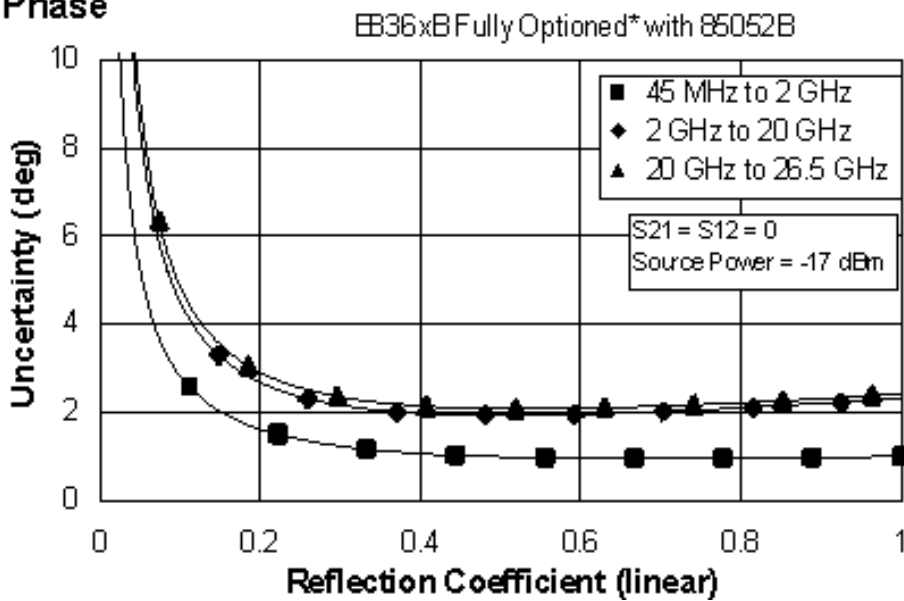

\* Configurable Test Set, Extended Power Range & Bias-Tees, Receiver Attenuators, Frequency Offset Mode, and Reference Channel Transfer Switch  
(E836xB - Option 014, UNL, 016, 080, and 081)

**Table 11.** 85052C Calibration Kit  
 Standard Configuration and Standard Power Range  
 (E836xB)

Applies to the, E836xB analyzers, 85052C (3.5mm) calibration kit, 85131F flexible test port cable set, and a full 2-port calibration. Also applies to the following condition:

Environmental temperature 23° ±3 °C, with < 1 °C deviation from calibration temperature

Description	Specification (dB)		
	45 MHz to 2 GHz	2 to 20 GHz	20 to 26.5 GHz
Directivity	48	50	50
Source Match	40	50	50
Load Match	48	50	50
Reflection Tracking	±0.003 +0.02/°C	±0.000 +0.02/°C	±0.000 +0.03/°C
Transmission Tracking	±0.009 +0.02/°C	±0.014 +0.02/°C	±0.018 +0.03/°C

## Transmission Uncertainty (Specifications)

### Magnitude

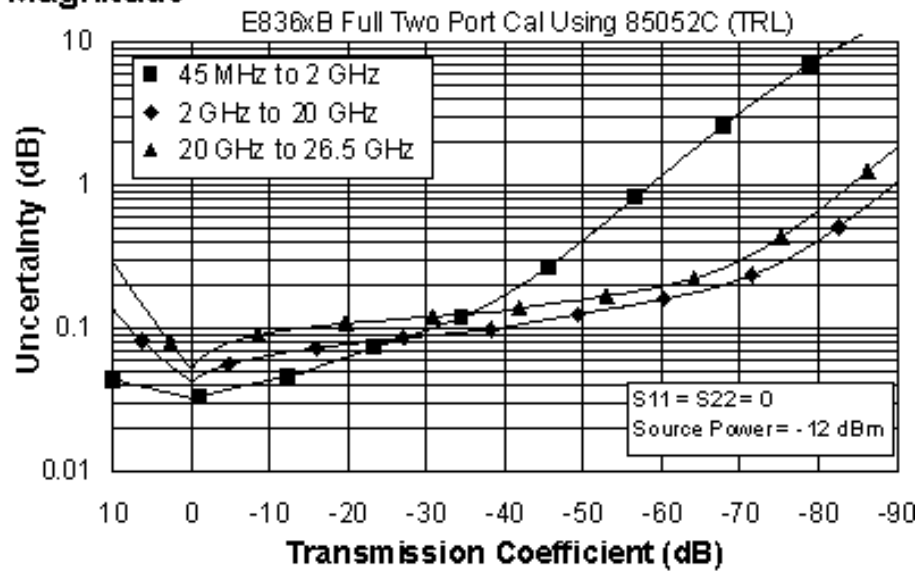

### Phase

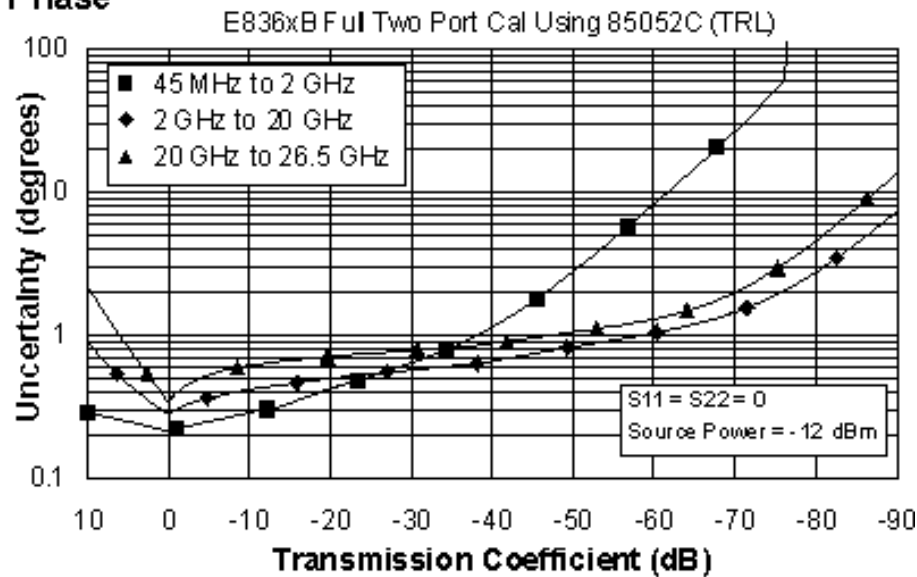

## Reflection Uncertainty (Specifications)

### Magnitude

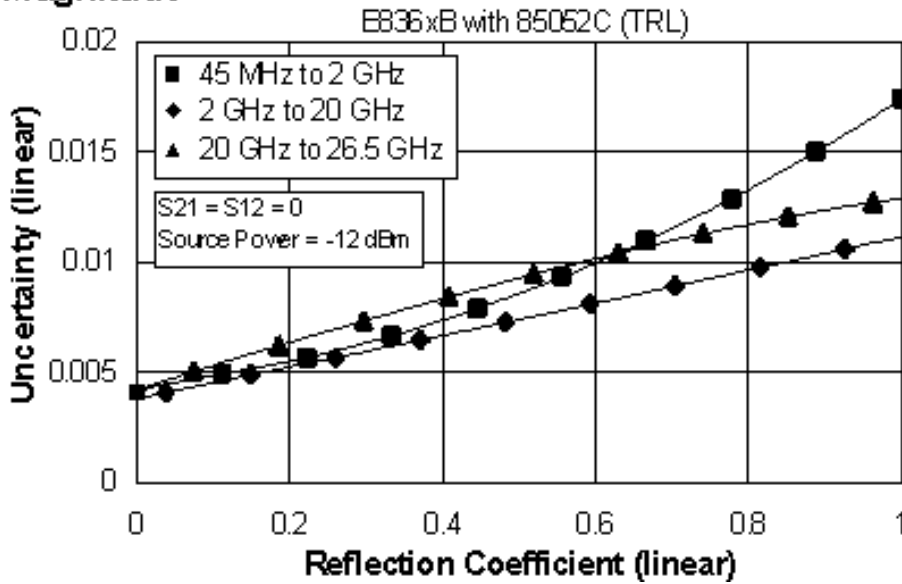

### Phase

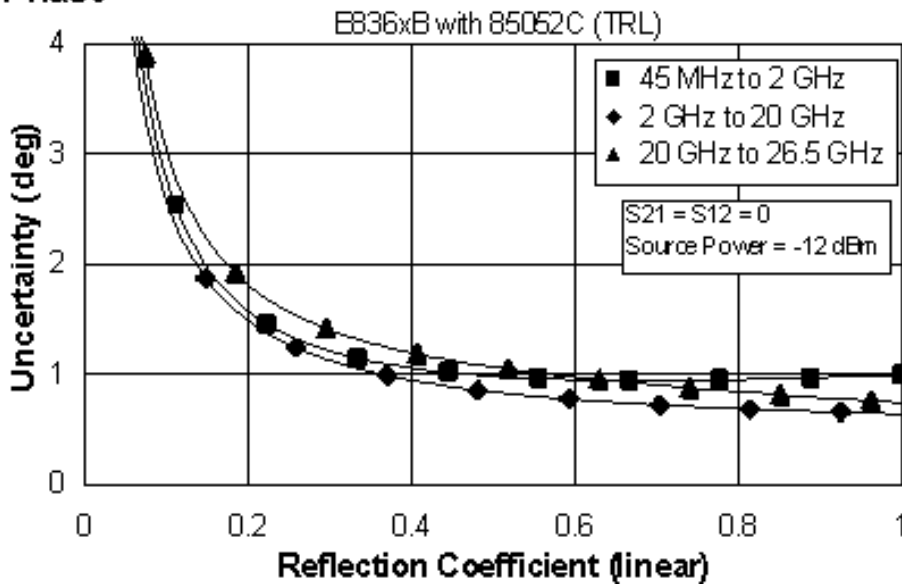

**Table 12.** 85052C Calibration Kit

Fully Optioned

Configurable Test Set, Extended Power Range & Bias-Tees, Receiver Attenuators, Frequency Offset Mode, and Reference Channel Transfer Switch

(E836xB - Option 014, UNL, 016, 080, and 081)

Applies to the, E836xB analyzers, 85052C (3.5mm) calibration kit, 85131F flexible test port cable set, and a full 2-port calibration. Also applies to the following condition:

Environmental temperature 23° ±3 °C, with < 1 °C deviation from calibration temperature

Description	Specification (dB)		
	45 MHz to 2 GHz	2 to 20 GHz	20 to 26.5 GHz
Directivity	48	50	50
Source Match	40	50	50
Load Match	48	50	50
Reflection Tracking	±0.003 +0.02/°C	±0.000 +0.02/°C	±0.000 +0.03/°C
Transmission Tracking	±0.017 +0.02/°C	±0.016 +0.02/°C	±0.019 +0.03/°C

## Transmission Uncertainty (Specifications)

### Magnitude

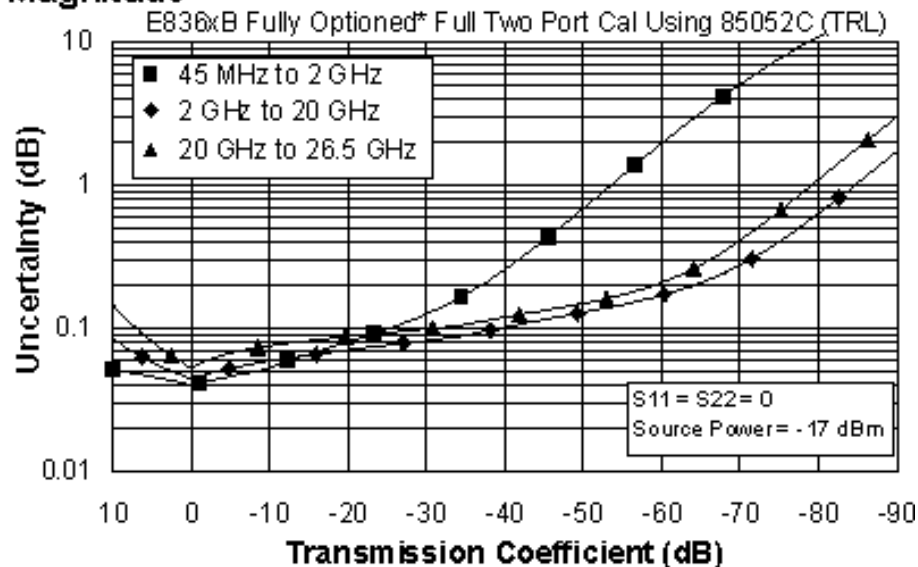

### Phase

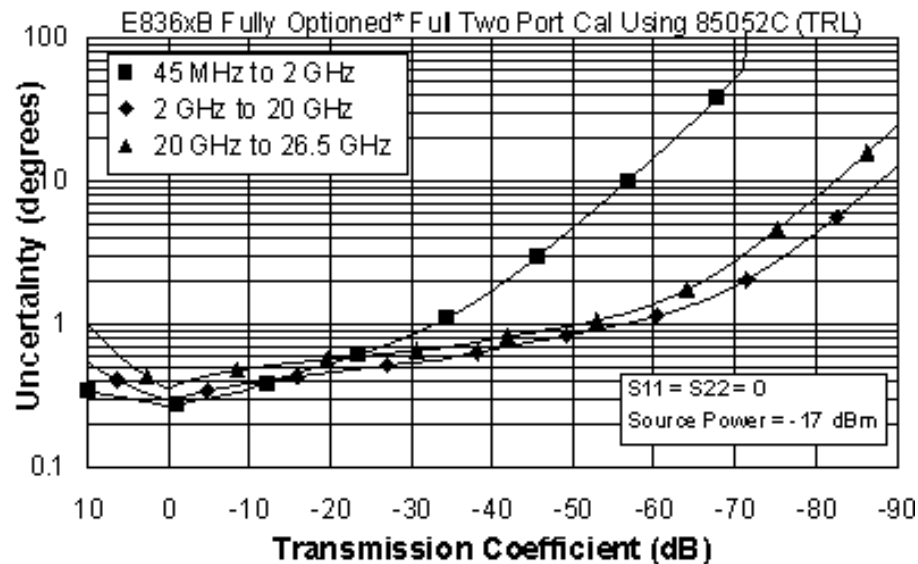

\* Configurable Test Set, Extended Power Range & Bias-Tees, Receiver Attenuators, Frequency Offset Mode, and Reference Channel Transfer Switch  
(E836xB - Option 014, UNL, 016, 080, and 081)



**Reflection Uncertainty (Specifications)**

**Magnitude**

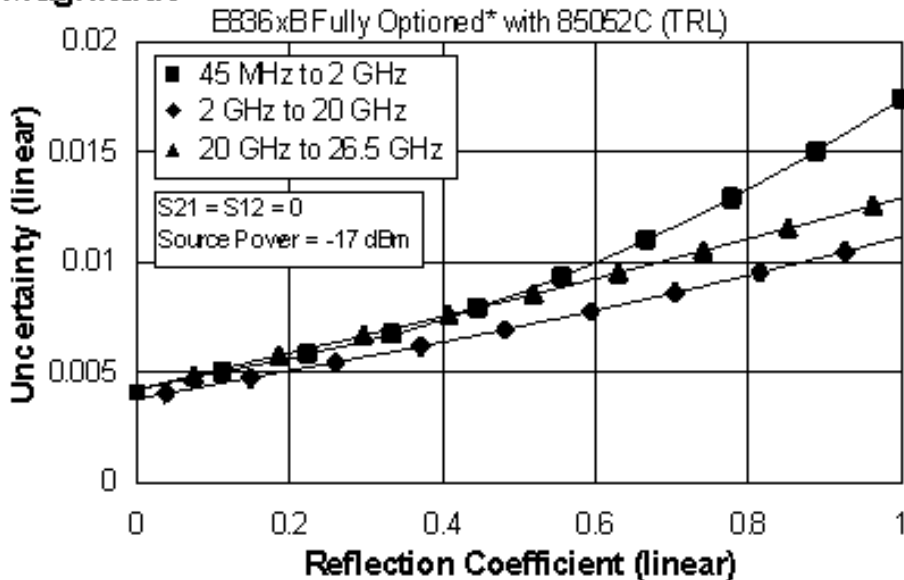

**Phase**

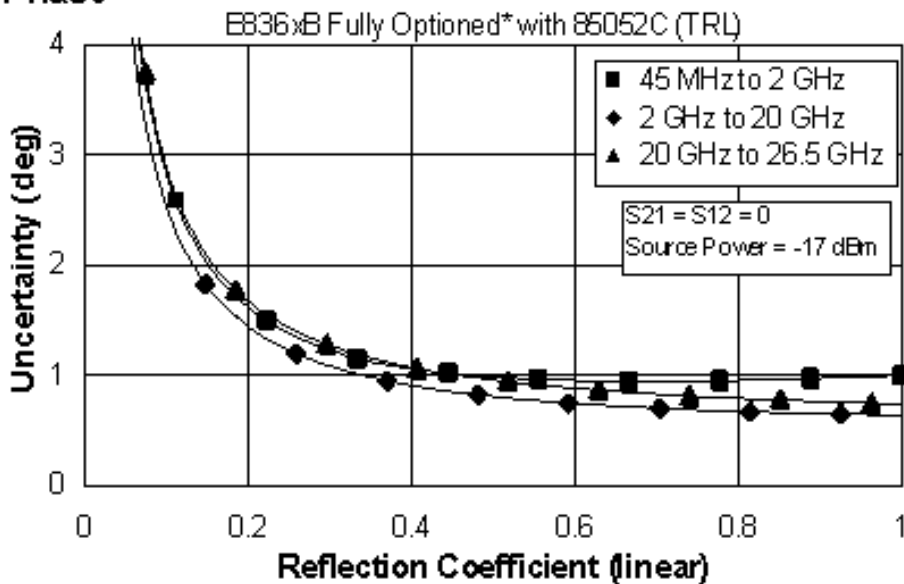

\* Configurable Test Set, Extended Power Range & Bias-Tees, Receiver Attenuators, Frequency Offset Mode, and Reference Channel Transfer Switch  
 (E836xB - Option 014, UNL, 016, 080, and 081)

**Table 13.** 85052D Calibration Kit  
 Standard Configuration and Standard Power Range  
 (E836xB)

Applies to the, E836xB analyzers, 85052D (3.5mm) calibration kit, 85131F flexible test port cable set, and a full 2-port calibration. Also applies to the following condition:

Environmental temperature 23° ±3 °C, with < 1 °C deviation from calibration temperature

Description	Specification (dB)		
	45 MHz to 2 GHz	2 to 20 GHz	20 to 26.5 GHz
Directivity	42	36	30
Source Match	37	28	25
Load Match	42	36	30
Reflection Tracking	±0.003 +0.02/°C	±0.008 +0.02/°C	±0.011 +0.03/°C
Transmission Tracking	±0.014 +0.02/°C	±0.131 +0.02/°C	±0.250 +0.03/°C

## Transmission Uncertainty (Specifications)

### Magnitude

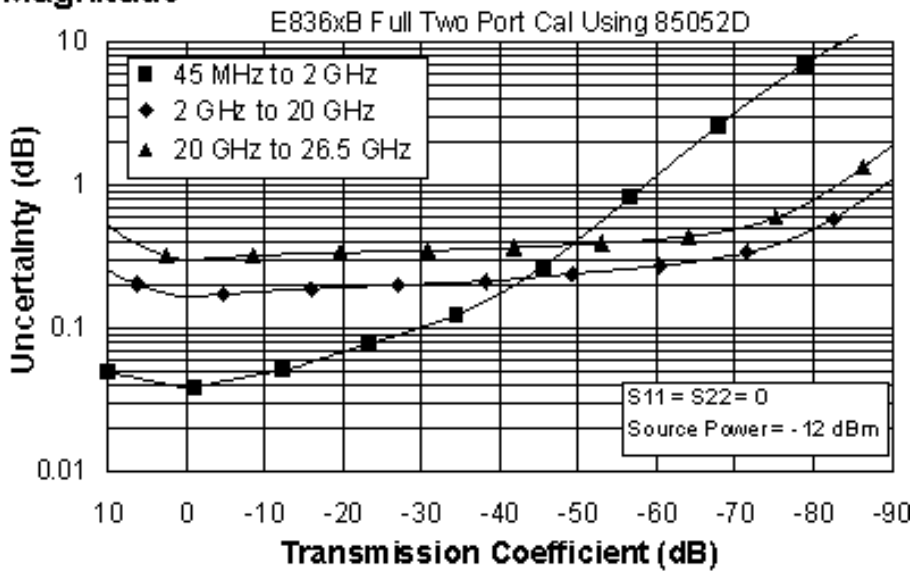

### Phase

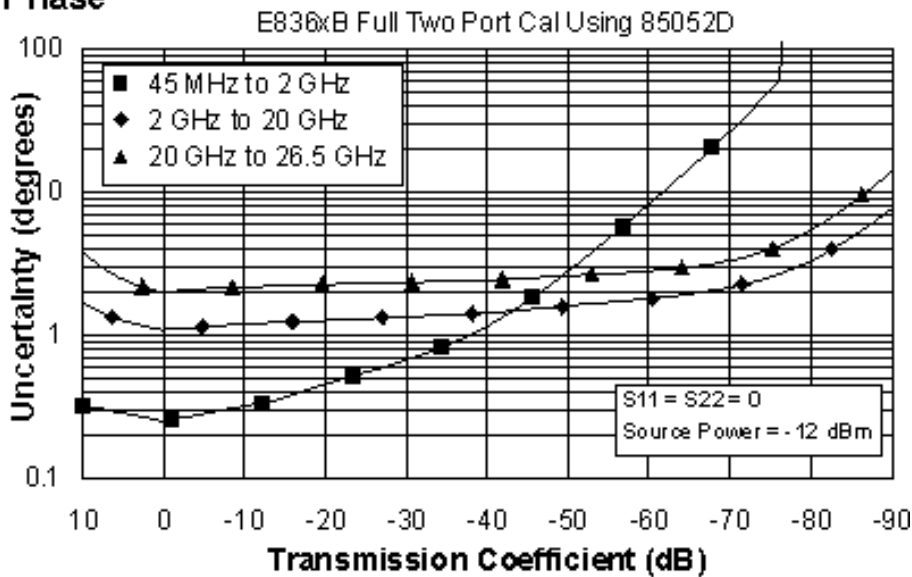

## Reflection Uncertainty (Specifications)

### Magnitude

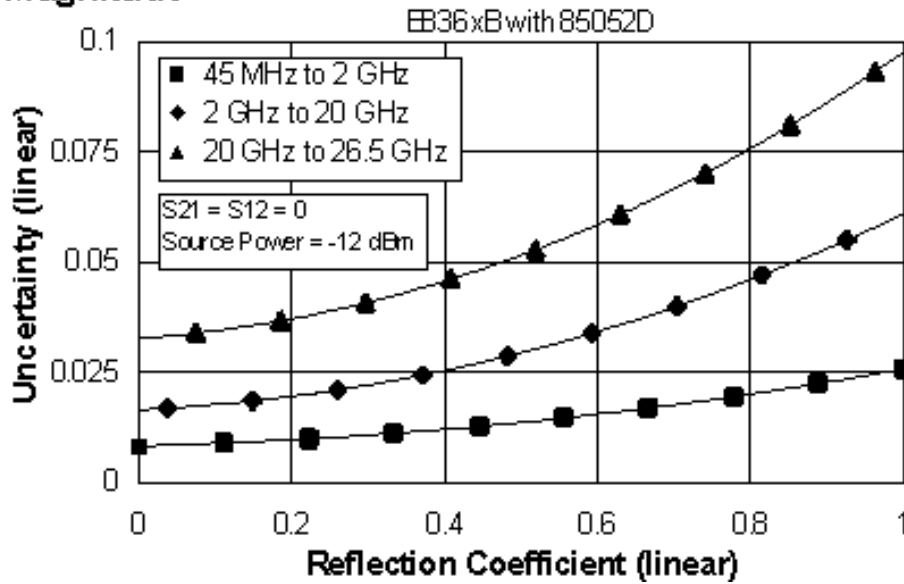

### Phase

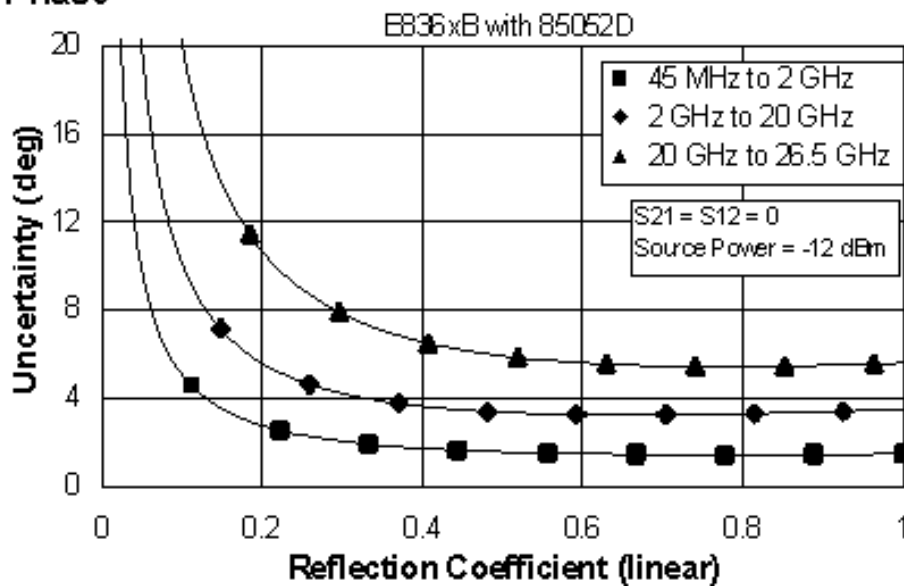

**Table 14.** 85052D Calibration Kit

Fully Optioned

Configurable Test Set, Extended Power Range & Bias-Tees, Receiver Attenuators, Frequency Offset Mode, and Reference Channel Transfer Switch

(E836xB - Option 014, UNL, 016, 080, and 081)

Applies to the, E836xB analyzers, 85052D (3.5mm) calibration kit, 85131F flexible test port cable set, and a full 2-port calibration. Also applies to the following condition:

Environmental temperature 23° ±3 °C, with < 1 °C deviation from calibration temperature

Description	Specification (dB)		
	45 MHz to 2 GHz	2 to 20 GHz	20 to 26.5 GHz
Directivity	42	36	30
Source Match	37	28	25
Load Match	42	36	30
Reflection Tracking	±0.003 +0.02/°C	±0.008 +0.02/°C	±0.011 +0.03/°C
Transmission Tracking	±0.026 +0.02/°C	±0.138 +0.02/°C	±0.261 +0.03/°C

**Transmission Uncertainty (Specifications)**

**Magnitude**

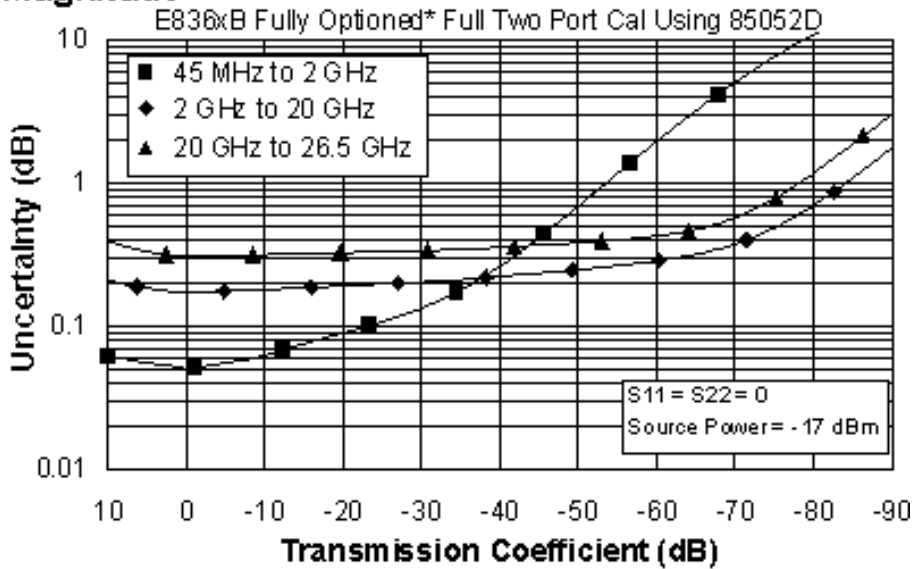

**Phase**

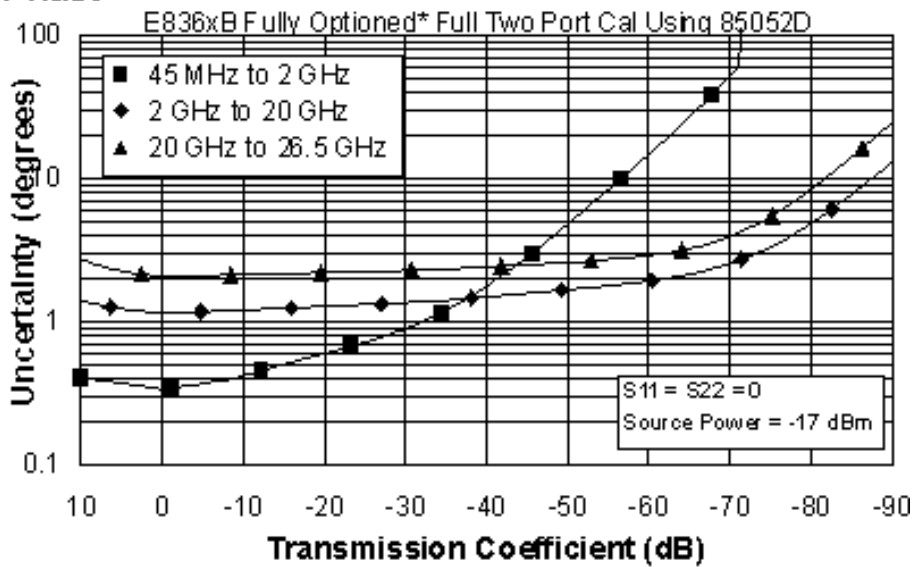

\* Configurable Test Set, Extended Power Range & Bias-Tees, Receiver Attenuators, Frequency Offset Mode, and Reference Channel Transfer Switch  
(E836xB - Option 014, UNL, 016, 080, and 081)

## Reflection Uncertainty (Specifications)

### Magnitude

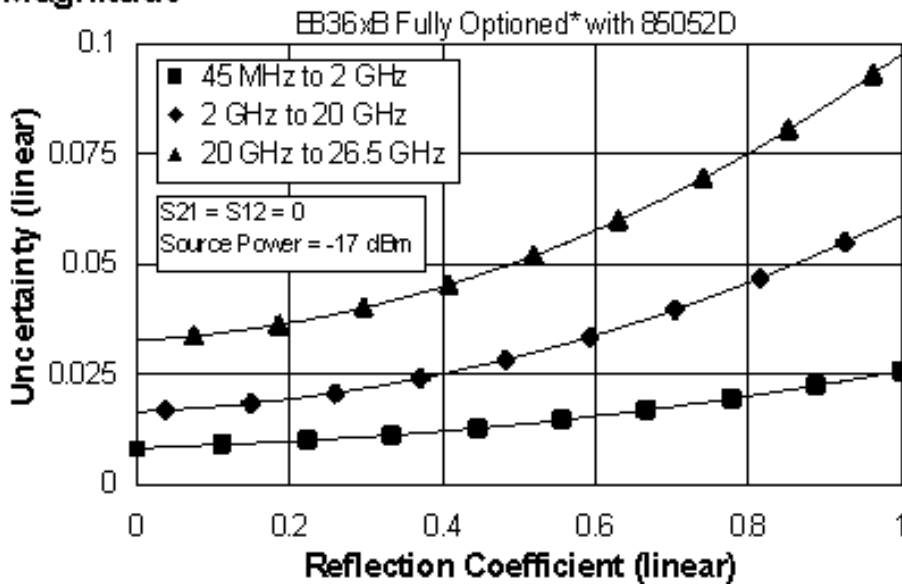

### Phase

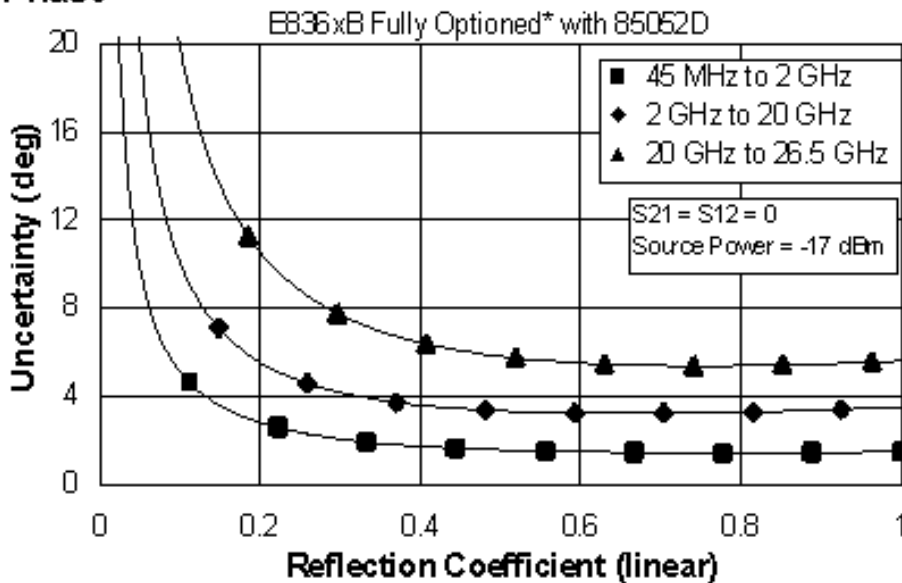

\* Configurable Test Set, Extended Power Range & Bias-Tees, Receiver Attenuators, Frequency Offset Mode, and Reference Channel Transfer Switch  
(E836xB - Option 014, UNL, 016, 080, and 081)

## E836xB Corrected System Performance with 7mm Connectors

**Table 15.** 85050B Calibration Kit  
Standard Configuration and Standard Power Range  
(E836xB)

Applies to the, E836xB analyzers, 85050B (7mm) calibration kit, 85132F flexible test port cable set, and a full 2-port calibration. Also applies to the following condition:

Environmental temperature  $23^{\circ} \pm 3^{\circ} \text{C}$ , with  $< 1^{\circ} \text{C}$  deviation from calibration temperature

Description	Specification (dB)	
	0.045 to 2 GHz	2 to 18 GHz
Directivity	52	52
Source Match	48	41
Load Match	52	47
Reflection Tracking	$\pm 0.003$ $+0.02/^{\circ}\text{C}$	$\pm 0.047$ $+0.02/^{\circ}\text{C}$
Transmission Tracking	$\pm 0.004$ $+0.02/^{\circ}\text{C}$	$\pm 0.032$ $+0.02/^{\circ}\text{C}$



## Transmission Uncertainty (Specifications)

### Magnitude

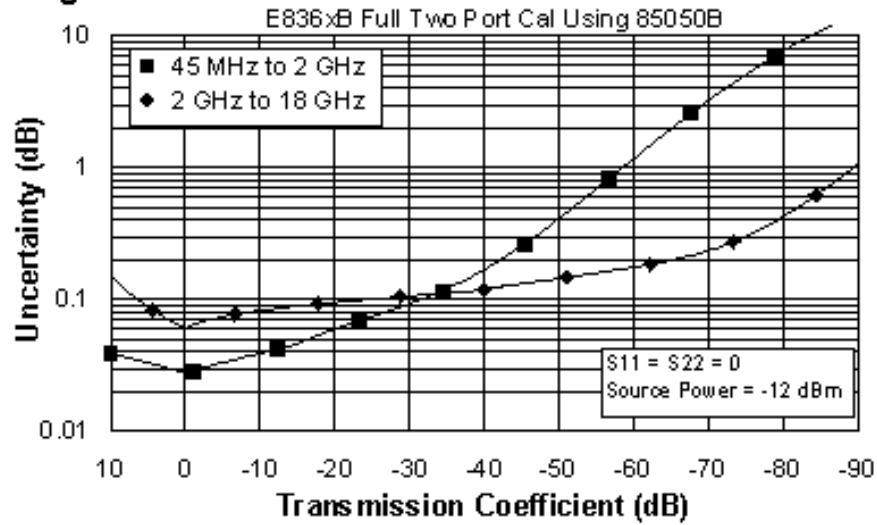

### Phase

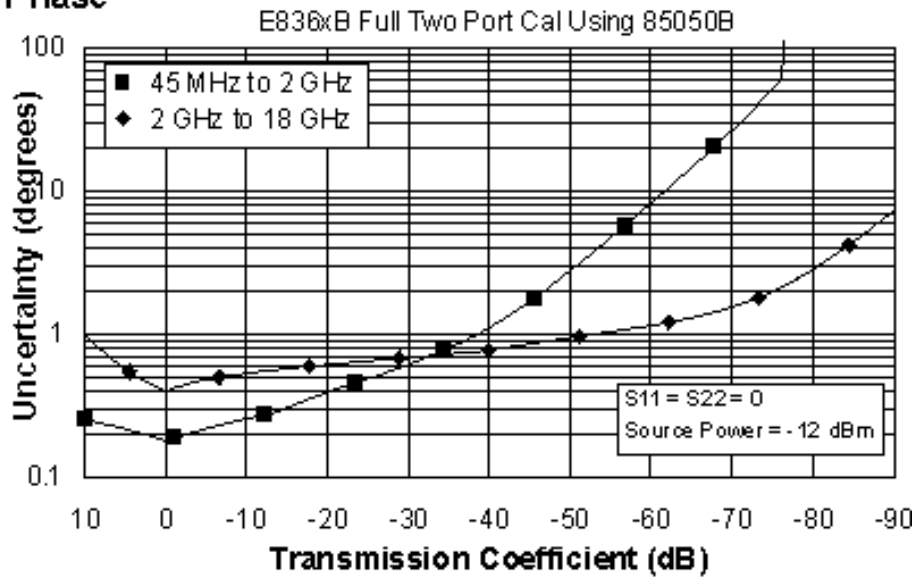

## Reflection Uncertainty (Specifications)

### Magnitude

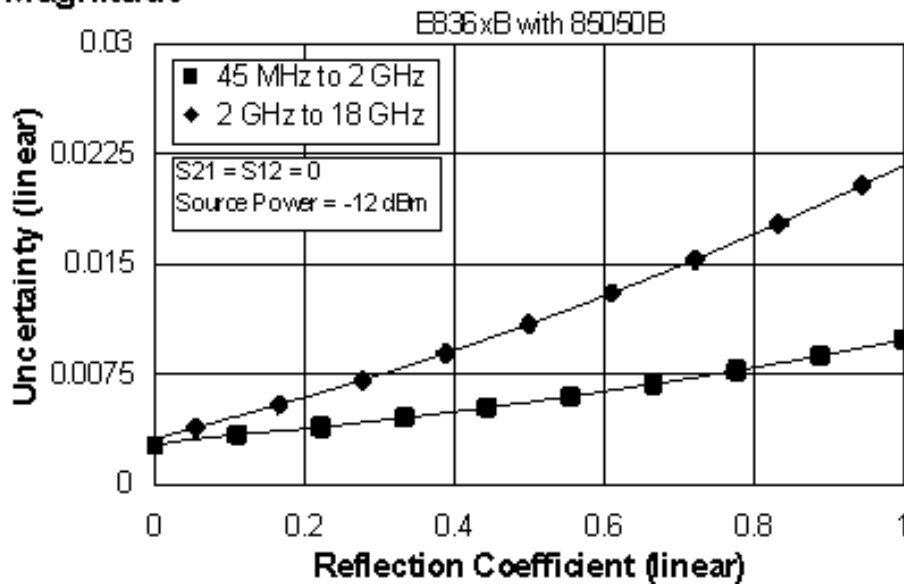

### Phase

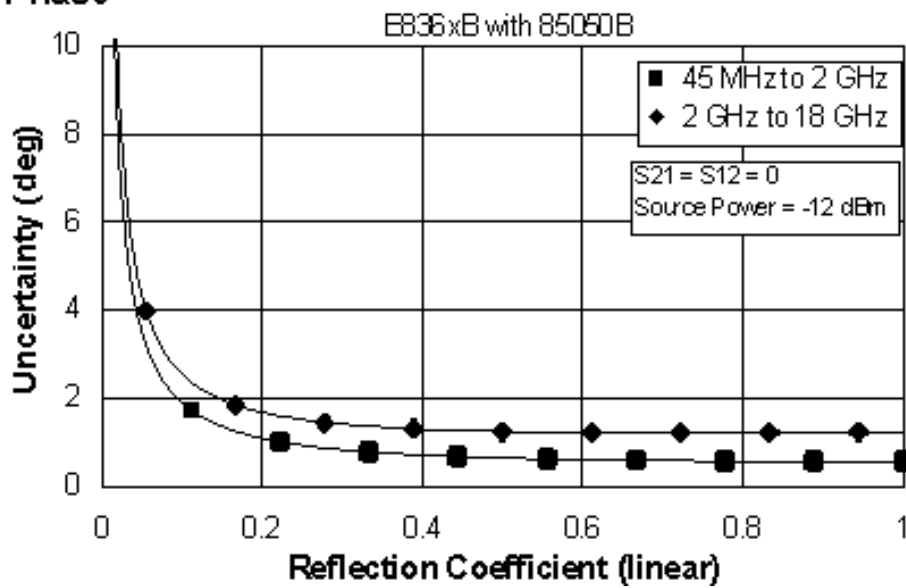

**Table 16.** 85050B Calibration Kit

Fully Optioned

Configurable Test Set, Extended Power Range & Bias-Tees, Receiver Attenuators, Frequency Offset Mode, and Reference Channel Transfer Switch

(E836xB - Option 014, UNL, 016, 080, and 081)

Applies to the, E836xB analyzers, 85050B (7mm) calibration kit, 85132F flexible test port cable set, and a full 2-port calibration. Also applies to the following condition:

Environmental temperature 23° ±3 °C, with < 1 °C deviation from calibration temperature

Description	Specification (dB)	
	0.045 to 2 GHz	2 to 18 GHz
Directivity	52	52
Source Match	48	41
Load Match	52	47
Reflection Tracking	±0.003 +0.02/°C	±0.047 +0.02/°C
Transmission Tracking	±0.008 +0.02/°C	±0.034 +0.02/°C

**Transmission Uncertainty (Specifications)**

**Magnitude**

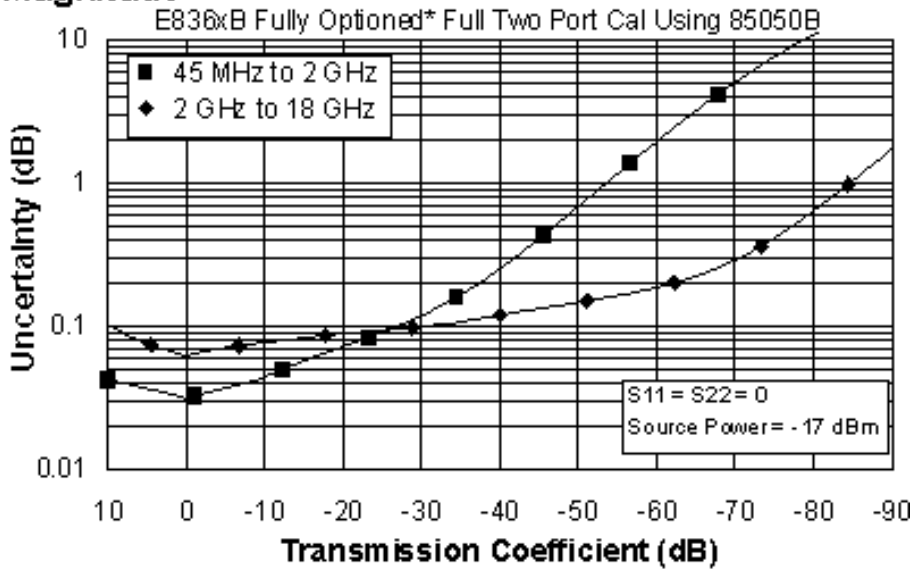

**Phase**

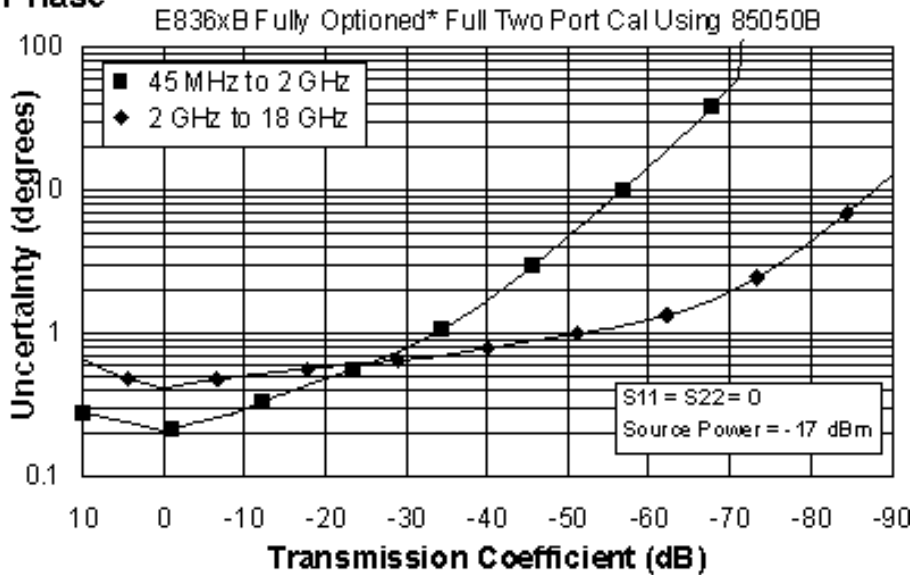

\*Configurable Test Set, Extended Power Range & Bias-Tees, Receiver Attenuators, Frequency Offset Mode, and Reference Channel Transfer Switch (E836xB - Option 014, UNL, 016, 080, and 081)

**Reflection Uncertainty (Specifications)**

**Magnitude**

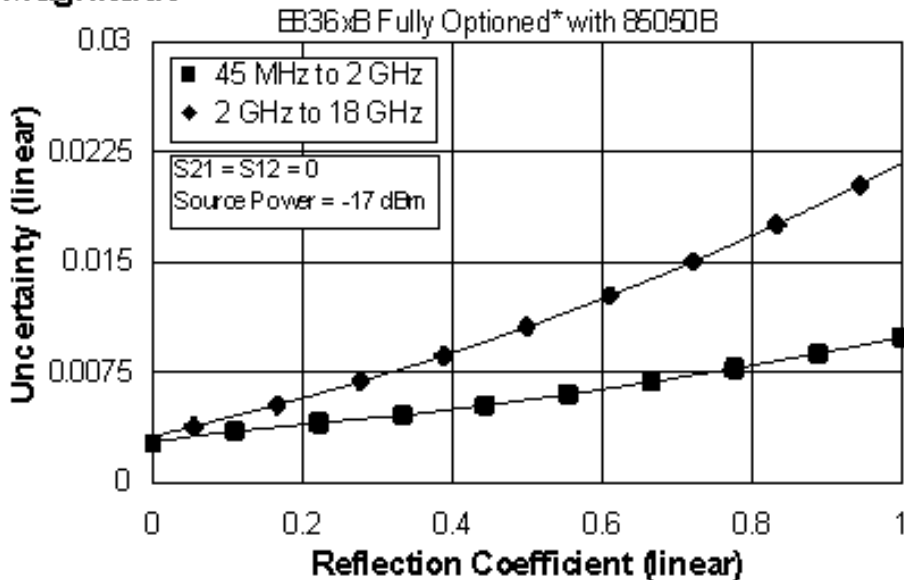

**Phase**

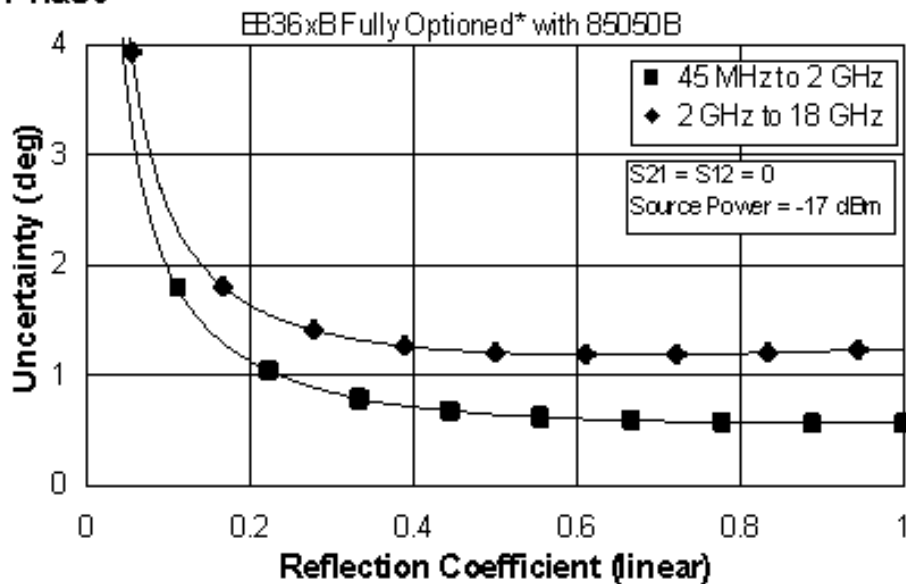

\*Configurable Test Set, Extended Power Range & Bias-Tees, Receiver Attenuators, Frequency Offset Mode, and Reference Channel Transfer Switch (E836xB - Option 014, UNL, 016, 080, and 081)

**Table 17.** 85050C Calibration Kit  
 Standard Configuration and Standard Power Range  
 (E836xB)

Applies to the, E836xB analyzers, 85050C (7mm) calibration kit, 85132F flexible test port cable set, and a full 2-port calibration. Also applies to the following condition:

Environmental temperature  $23^{\circ} \pm 3^{\circ} \text{C}$ , with  $< 1^{\circ} \text{C}$  deviation from calibration temperature

Description	Specification (dB)	
	0.045 to 2 GHz	2 to 18 GHz
Directivity	52	60
Source Match	48	60
Load Match	52	60
Reflection Tracking	$\pm 0.003$ $+0.02/^{\circ}\text{C}$	$\pm 0.000$ $+0.02/^{\circ}\text{C}$
Transmission Tracking	$\pm 0.004$ $+0.02/^{\circ}\text{C}$	$\pm 0.004$ $+0.02/^{\circ}\text{C}$

## Transmission Uncertainty (Specifications)

### Magnitude

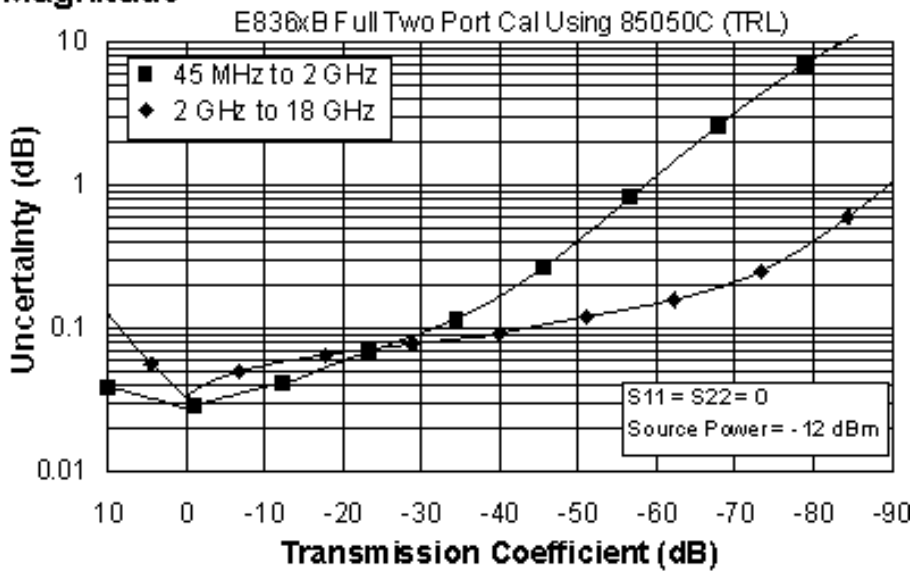

### Phase

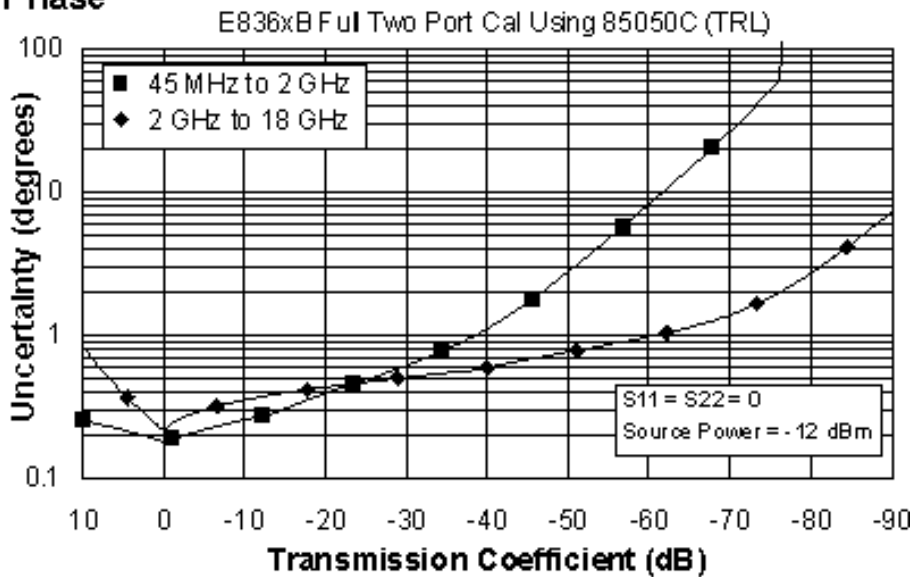

Reflection Uncertainty (Specifications)

Magnitude

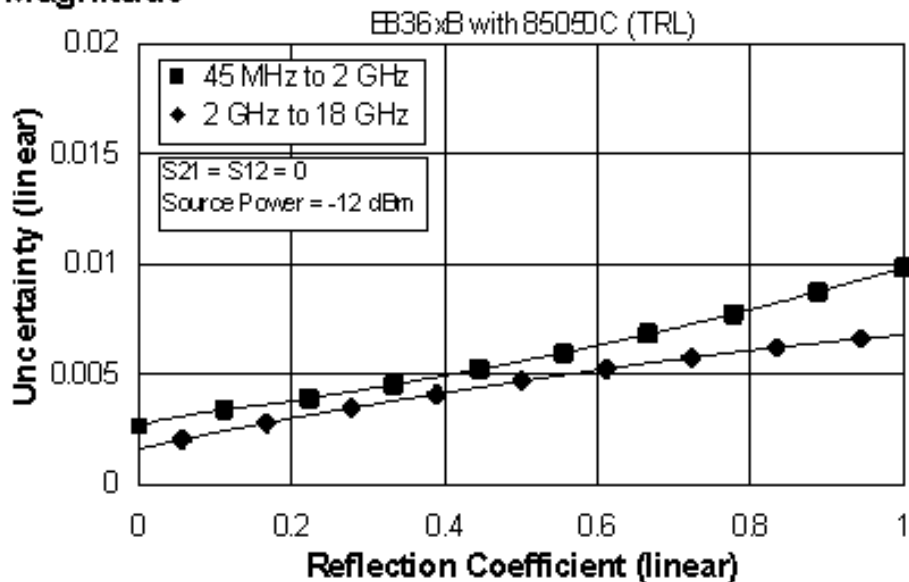

Phase

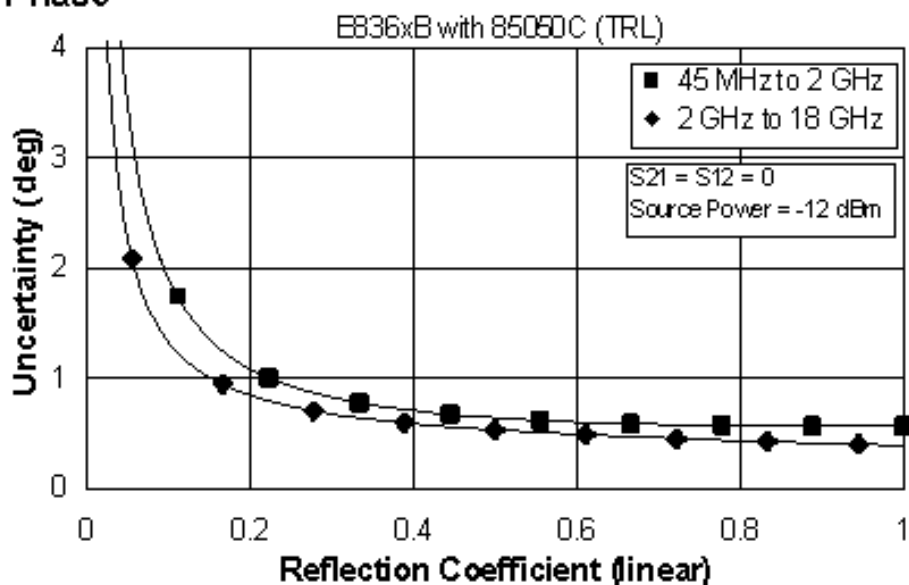



**Table 18.** 85050C Calibration Kit

Fully Optioned

Configurable Test Set, Extended Power Range & Bias-Tees, Receiver Attenuators, Frequency Offset Mode, and Reference Channel Transfer Switch

(E836xB - Option 014, UNL, 016, 080, and 081)

Applies to the, E836xB analyzers, 85050C (7mm) calibration kit, 85132F flexible test port cable set, and a full 2-port calibration. Also applies to the following condition:

Environmental temperature 23° ±3 °C, with < 1 °C deviation from calibration temperature

Description	Specification (dB)	
	0.045 to 2 GHz	2 to 18 GHz
Directivity	52	60
Source Match	48	60
Load Match	52	60
Reflection Tracking	±0.003 +0.02/°C	±0.000 +0.02/°C
Transmission Tracking	±0.008 +0.02/°C	±0.005 +0.02/°C

**Transmission Uncertainty (Specifications)**

**Magnitude**

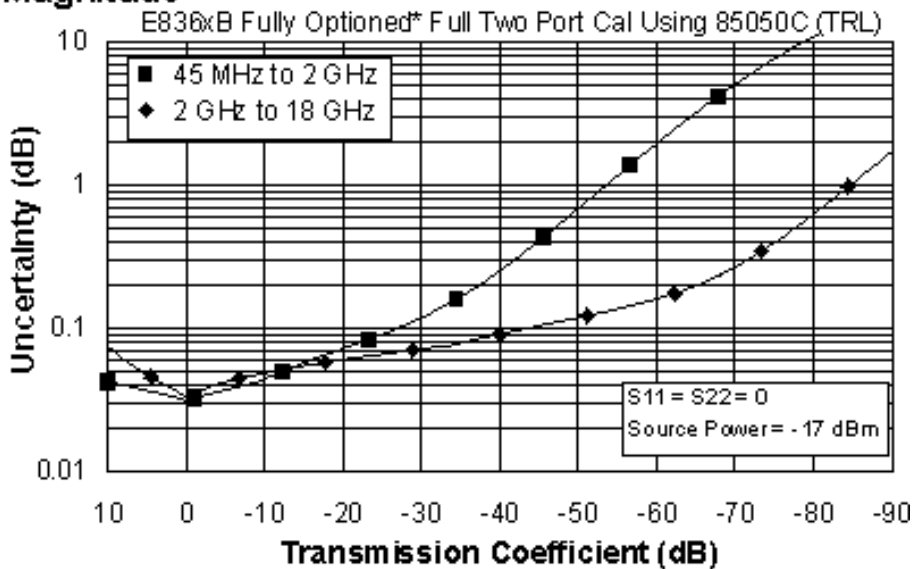

**Phase**

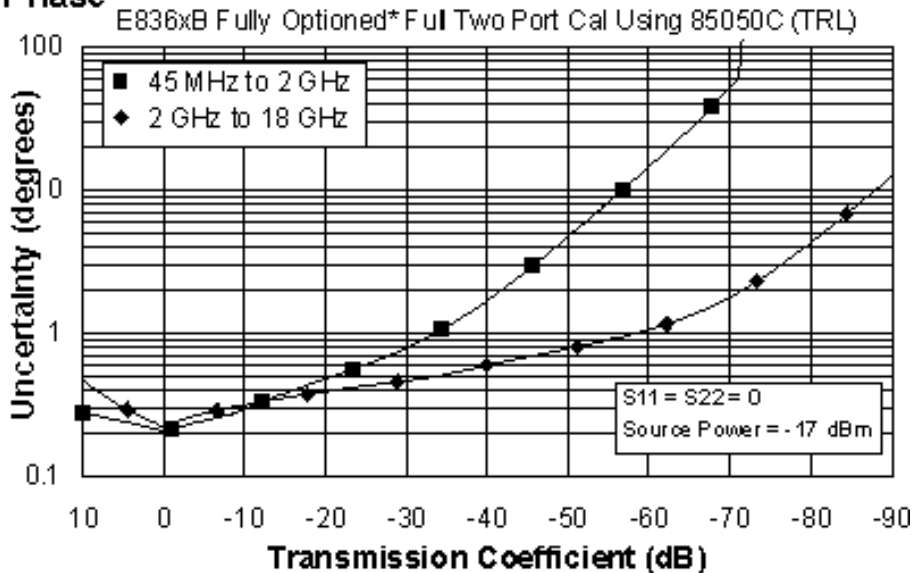

\*Configurable Test Set, Extended Power Range & Bias-Tees, Receiver Attenuators, Frequency Offset Mode, and Reference Channel Transfer Switch (E836xB - Option 014, UNL, 016, 080, and 081)

**Reflection Uncertainty (Specifications)**

**Magnitude**

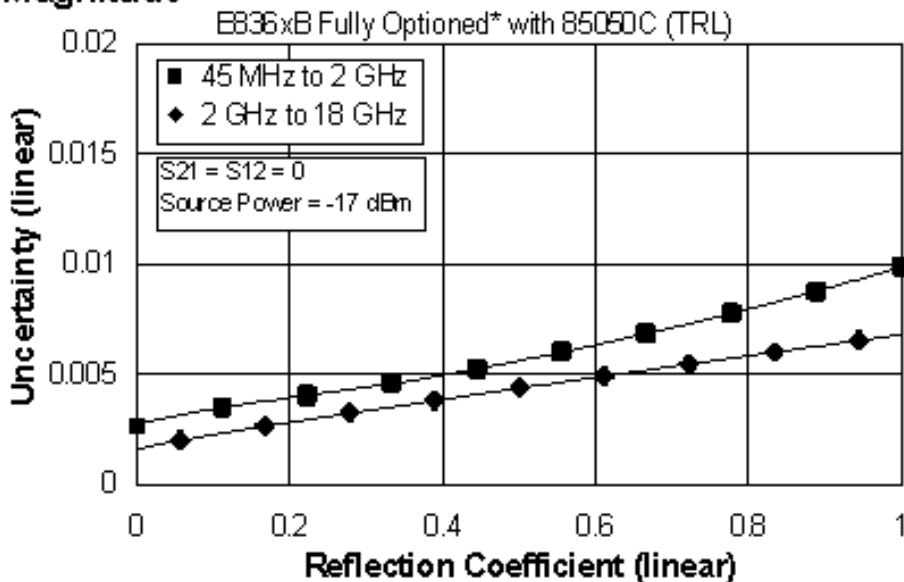

**Phase**

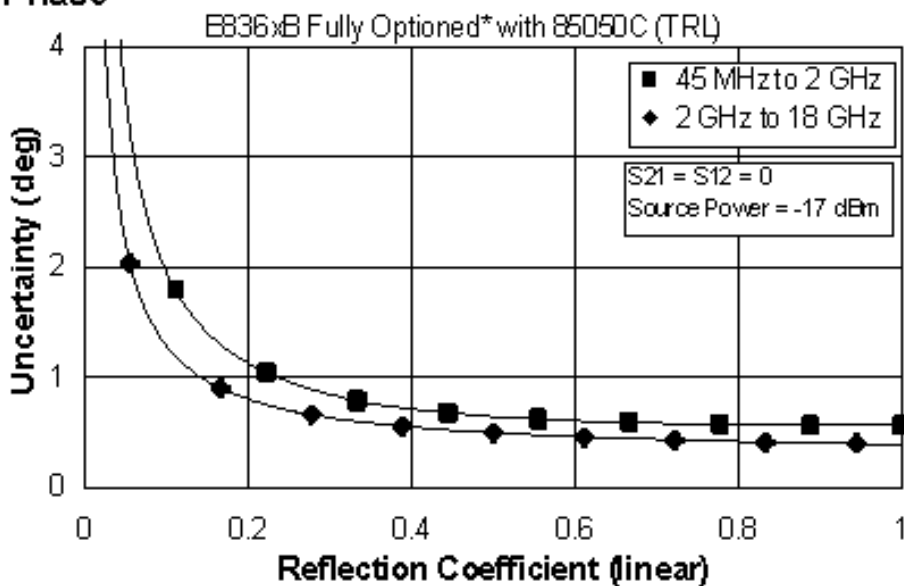

\*Configurable Test Set, Extended Power Range & Bias-Tees, Receiver Attenuators, Frequency Offset Mode, and Reference Channel Transfer Switch (E836xB - Option 014, UNL, 016, 080, and 081)

**Table 19.** 85050D Calibration Kit  
 Standard Configuration and Standard Power Range  
 (E836xB)

Applies to the, E836xB analyzers, 85050D (7mm) calibration kit, 85132F flexible test port cable set, and a full 2-port calibration. Also applies to the following condition:

Environmental temperature 23° ±3 °C, with < 1 °C deviation from calibration temperature

Description	Specification (dB)	
	0.045 to 2 GHz	2 to 18 GHz
Directivity	40	40
Source Match	39	35
Load Match	40	37
Reflection Tracking	±0.010 +0.02/°C	±0.100 +0.02/°C
Transmission Tracking	±0.013 +0.02/°C	±0.072 +0.02/°C

## Transmission Uncertainty (Specifications)

### Magnitude

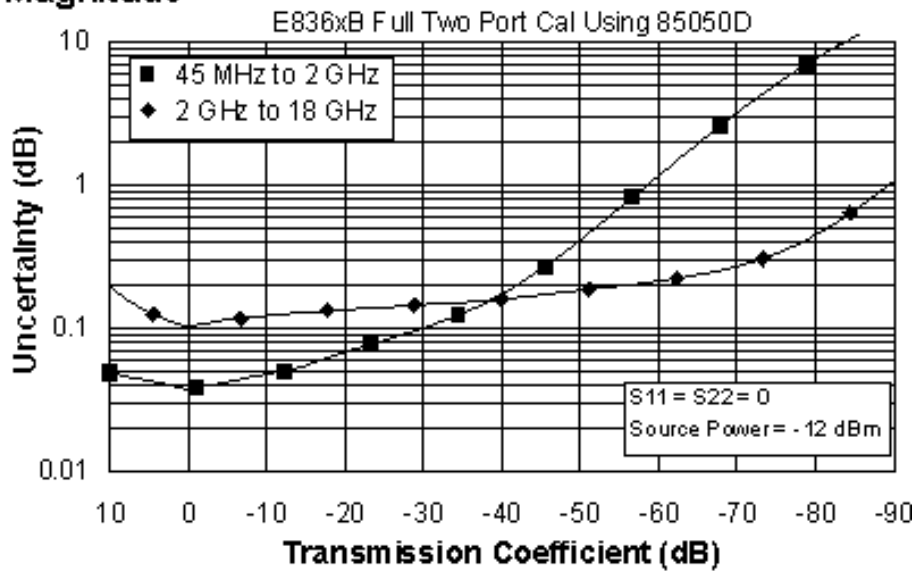

### Phase

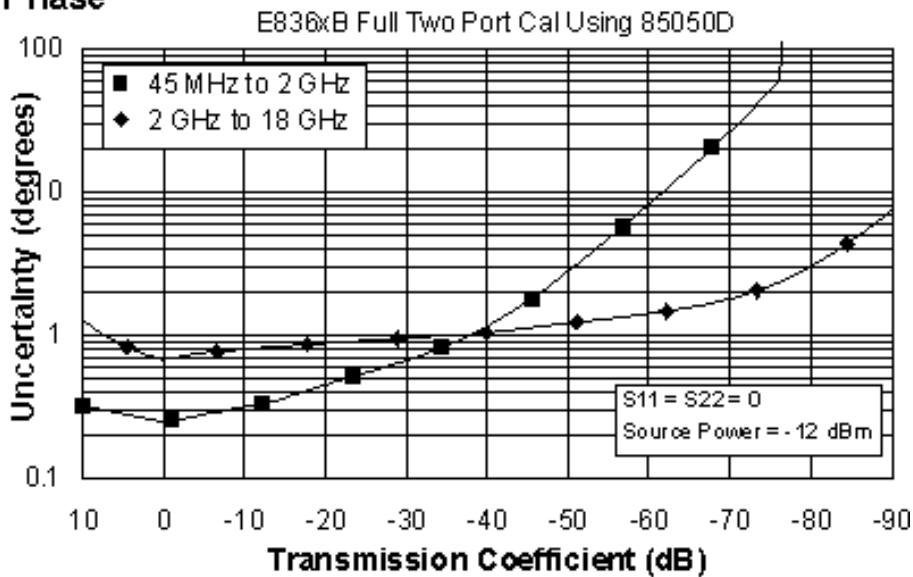

## Reflection Uncertainty (Specifications)

### Magnitude

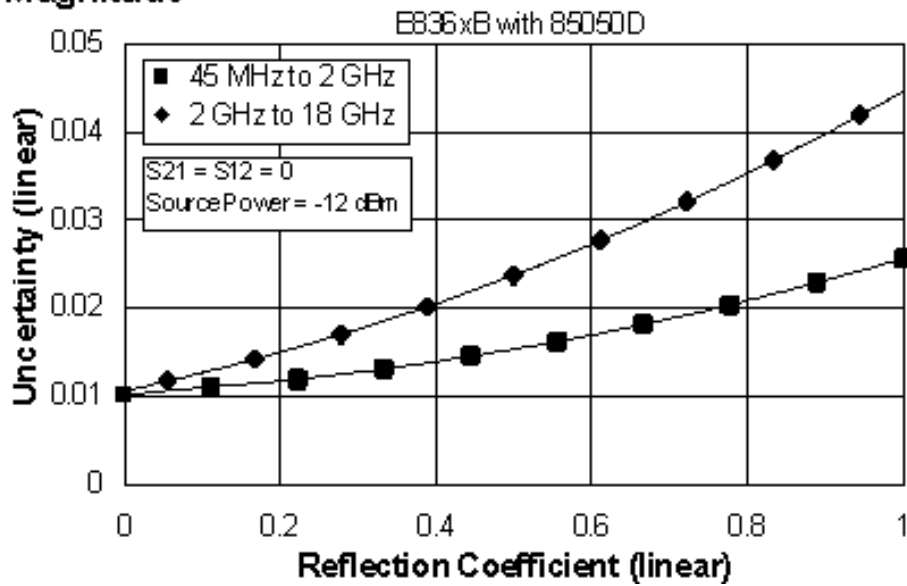

### Phase

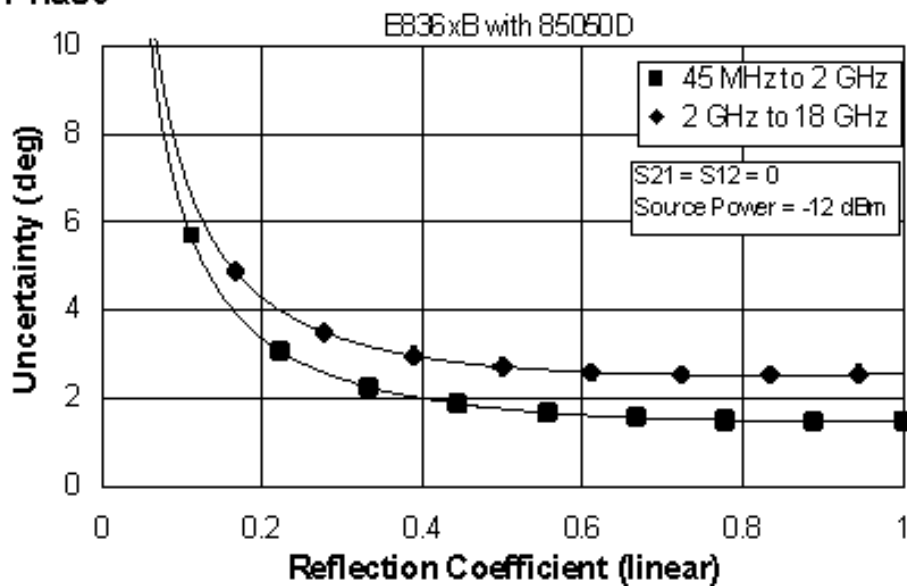

**Table 20.** 85050D Calibration Kit

Fully Optioned

\*Configurable Test Set, Extended Power Range & Bias-Tees, Receiver Attenuators, Frequency Offset Mode, and Reference Channel Transfer Switch

(E836xB - Option 014, UNL, 016, 080, and 081)

Applies to the, E836xB analyzers, 85050D (7mm) calibration kit, 85132F flexible test port cable set, and a full 2-port calibration. Also applies to the following condition:

Environmental temperature 23° ±3 °C, with < 1 °C deviation from calibration temperature

Description	Specification (dB)	
	0.045 to 2 GHz	2 to 18 GHz
Directivity	40	40
Source Match	39	35
Load Match	40	37
Reflection Tracking	±0.010 +0.02/°C	±0.100 +0.02/°C
Transmission Tracking	±0.025 +0.02/°C	±0.078 +0.02/°C

**Transmission Uncertainty (Specifications)**

**Magnitude**

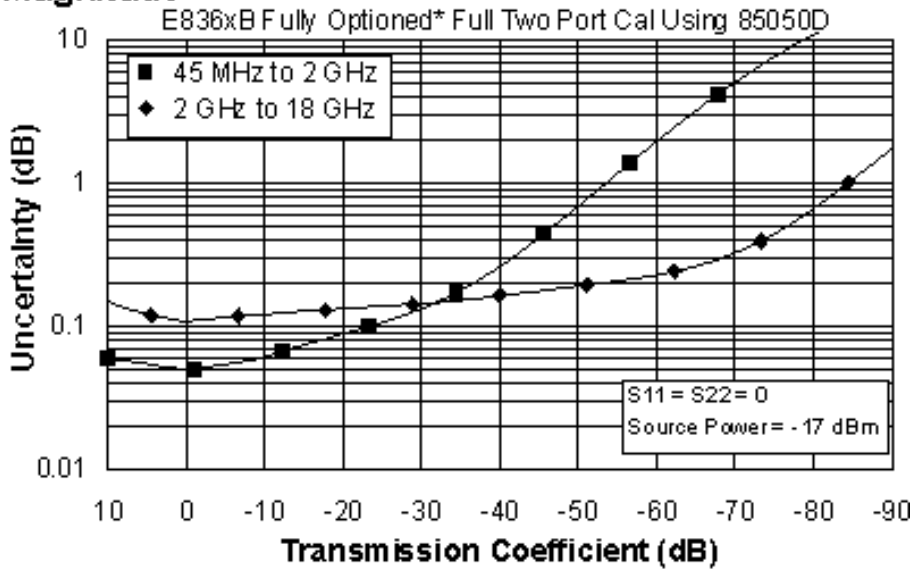

**Phase**

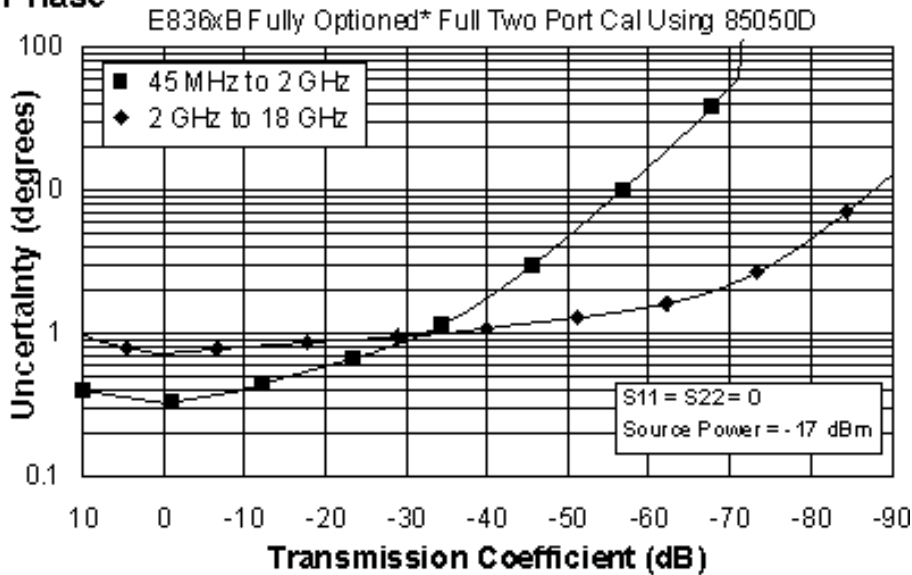

\*Configurable Test Set, Extended Power Range & Bias-Tees, Receiver Attenuators, Frequency Offset Mode, and Reference Channel Transfer Switch (E836xB - Option 014, UNL, 016, 080, and 081)



**Reflection Uncertainty (Specifications)**

**Magnitude**

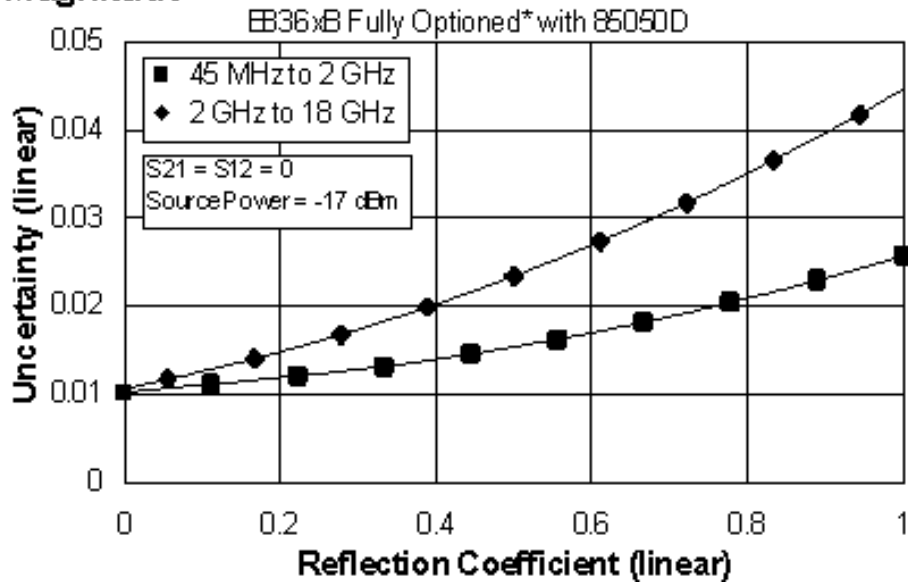

**Phase**

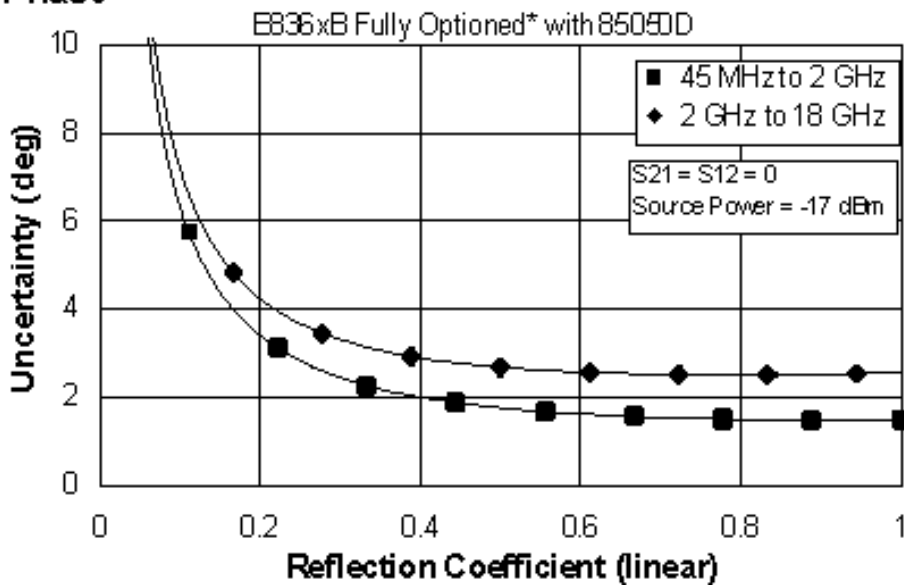

\*Configurable Test Set, Extended Power Range & Bias-Tees, Receiver Attenuators, Frequency Offset Mode, and Reference Channel Transfer Switch (E836xB - Option 014, UNL, 016, 080, and 081)

## E836xB Corrected System Performance with Type-N Connectors

**Table 21.** 85054B Calibration Kit  
Standard Configuration and Standard Power Range  
(E836xB)

Applies to the, E836xB analyzers, 85054B (Type-N) calibration kit, 85132F flexible test port cable set with 85130C adapter set, and a full 2-port calibration. Also applies to the following condition:

Environmental temperature 23° ±3 °C, with < 1 °C deviation from calibration temperature

Description	Specification (dB)	
	0.045 to 2 GHz	2 to 18 GHz
Directivity	48	42
Source Match	45	33
Load Match	48	41
Reflection Tracking	±0.001 +0.02/°C	±0.015 +0.02/°C
Transmission Tracking	±0.006 +0.02/°C	±0.079 +0.02/°C

## Transmission Uncertainty (Specifications)

### Magnitude

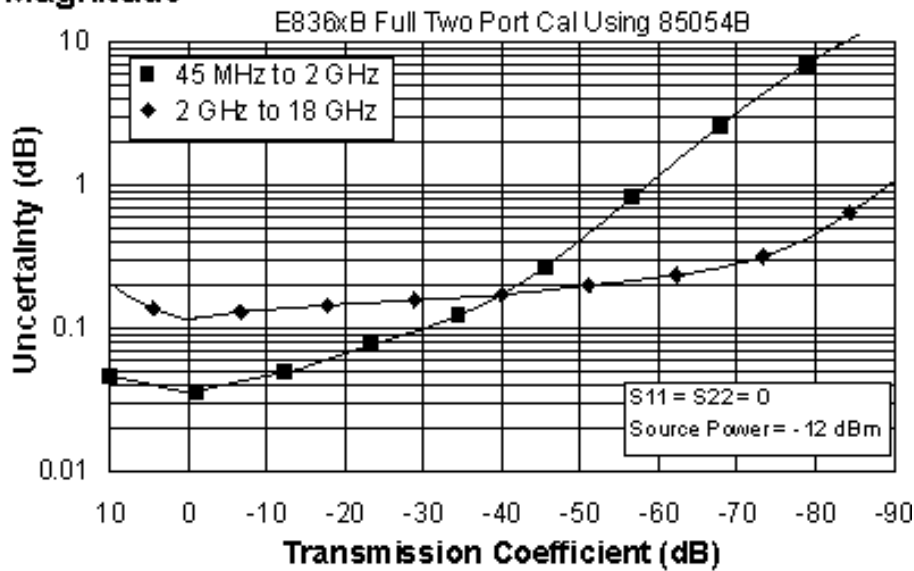

### Phase

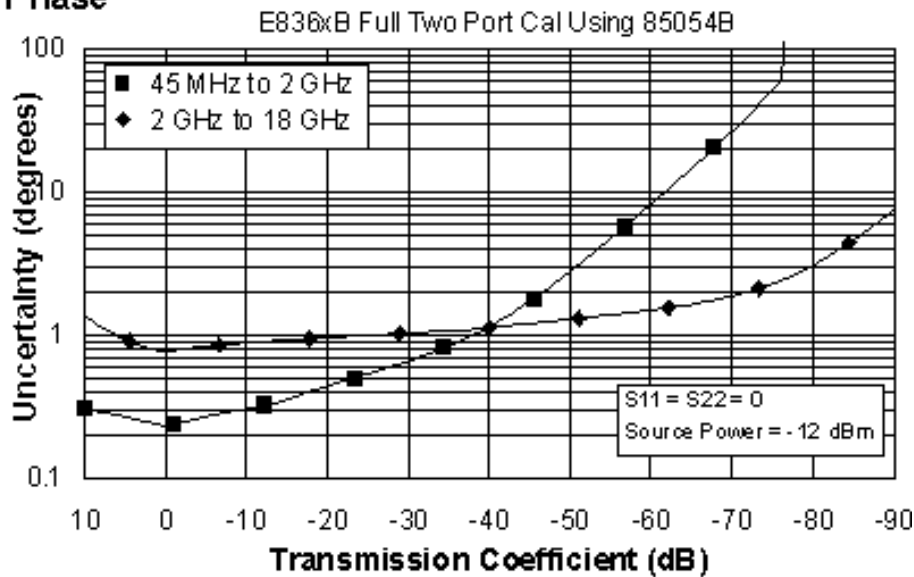

Reflection Uncertainty (Specifications)

Magnitude

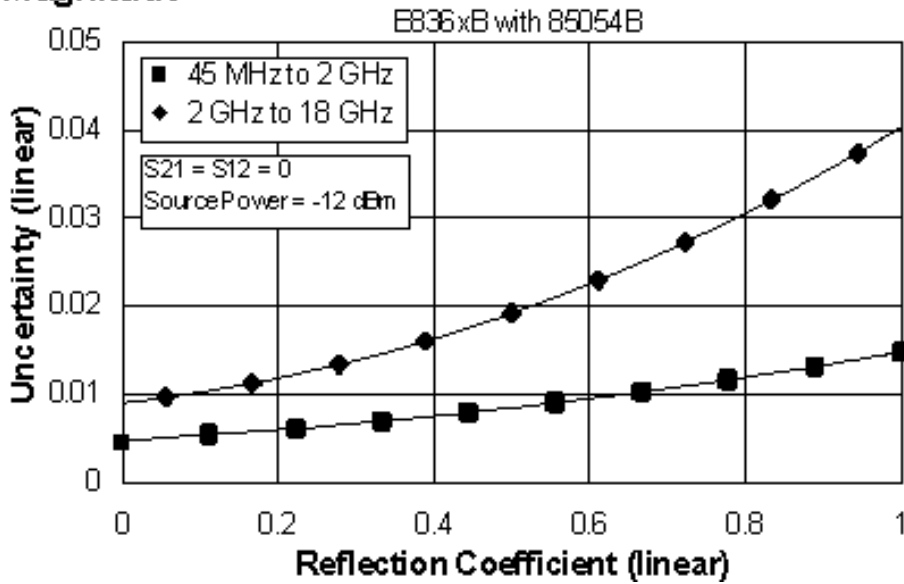

Phase

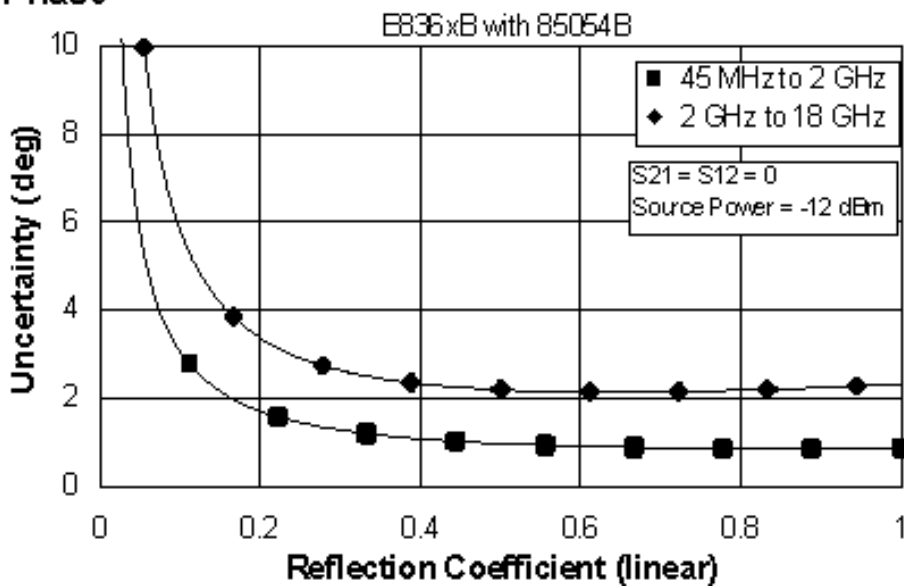

**Table 22. 85054B Calibration Kit**

Fully Optioned

Configurable Test Set, Extended Power Range & Bias-Tees, Receiver Attenuators, Frequency Offset Mode, and Reference Channel Transfer Switch

(E836xB - Option 014, UNL, 016, 080, and 081)

Applies to the, E836xB analyzers, 85054B (Type-N) calibration kit, 85132F flexible test port cable set with 85130C adapter set, and a full 2-port calibration. Also applies to the following condition:

Environmental temperature 23° ±3 °C, with < 1 °C deviation from calibration temperature

Description	Specification (dB)	
	0.045 to 2 GHz	2 to 18 GHz
Directivity	48	42
Source Match	45	33
Load Match	48	41
Reflection Tracking	±0.001 +0.02/°C	±0.015 +0.02/°C
Transmission Tracking	±0.011 +0.02/°C	±0.083 +0.02/°C

**Transmission Uncertainty (Specifications)**

**Magnitude**

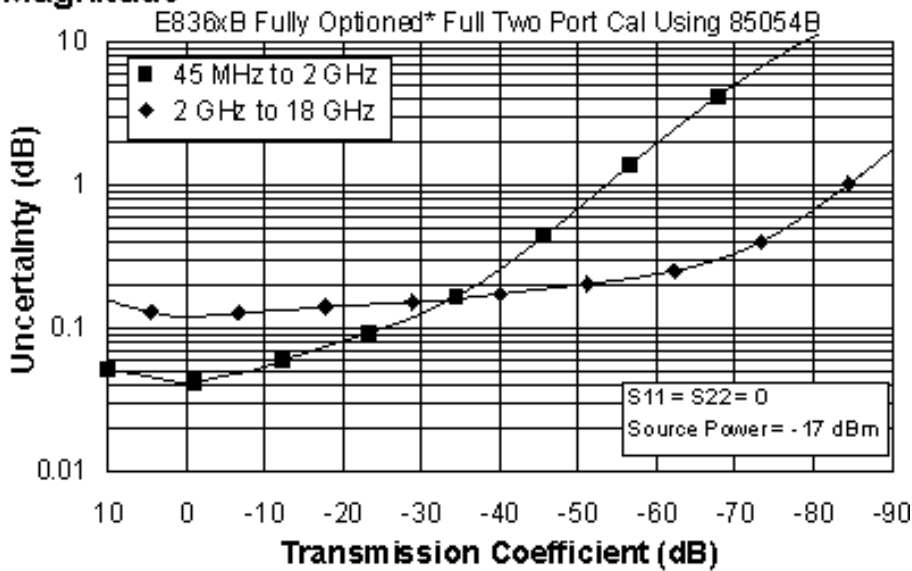

**Phase**

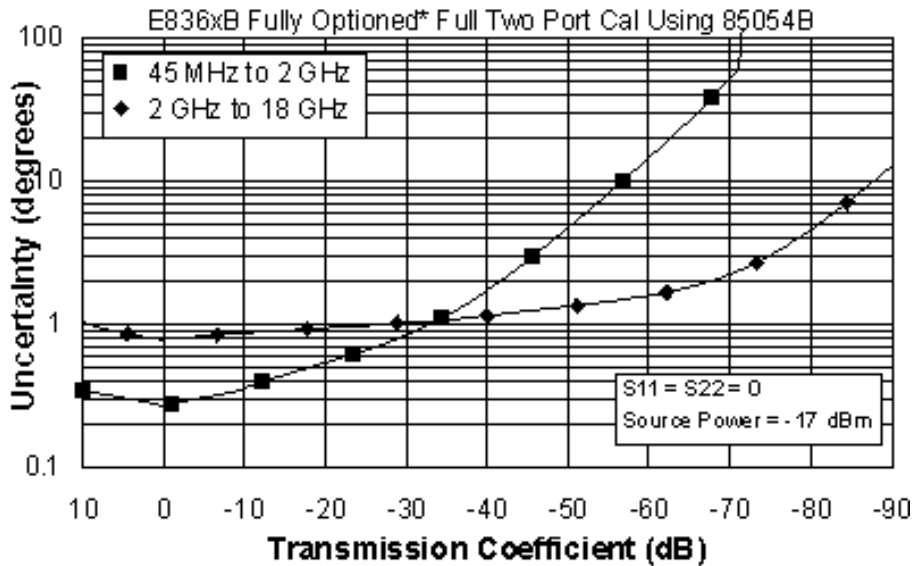

\* Configurable Test Set, Extended Power Range & Bias-Tees, Receiver Attenuators, Frequency Offset Mode, and Reference Channel Transfer Switch  
(E836xB - Option 014, UNL, 016, 080, and 081)

**Reflection Uncertainty (Specifications)**

**Magnitude**

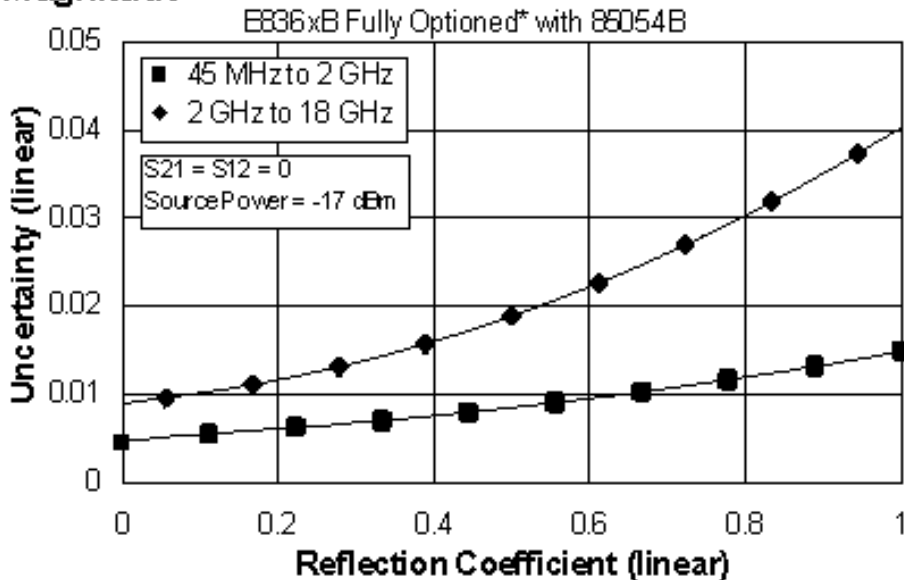

**Phase**

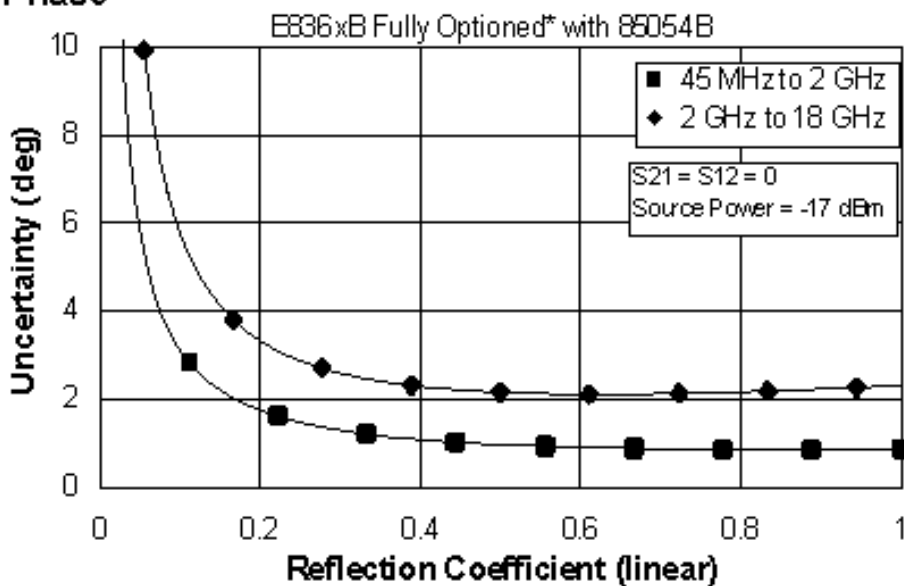

\* Configurable Test Set, Extended Power Range & Bias-Tees, Receiver Attenuators, Frequency Offset Mode, and Reference Channel Transfer Switch  
 (E836xB - Option 014, UNL, 016, 080, and 081)

**Table 23.** 85054D Calibration Kit  
 Standard Configuration and Standard Power Range  
 (E836xB)

Applies to the, E836xB analyzers, 85054D (Type-N) calibration kit, 85132F flexible test port cable set with 85130C adapter set, and a full 2-port calibration. Also applies to the following condition:

Environmental temperature 23° ±3 °C, with < 1 °C deviation from calibration temperature

Description	Specification (dB)	
	0.045 to 2 GHz	2 to 18 GHz
Directivity	40	34
Source Match	39	29
Load Match	40	34
Reflection Tracking	±0.003 +0.02/°C	±0.027 +0.02/°C
Transmission Tracking	±0.013 +0.02/°C	±0.136 +0.02/°C



## Transmission Uncertainty (Specifications)

### Magnitude

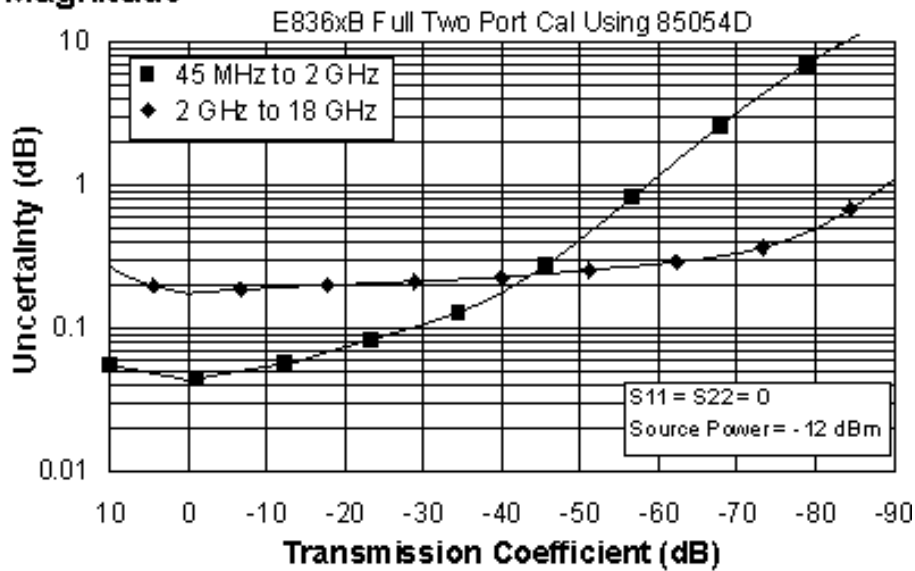

### Phase

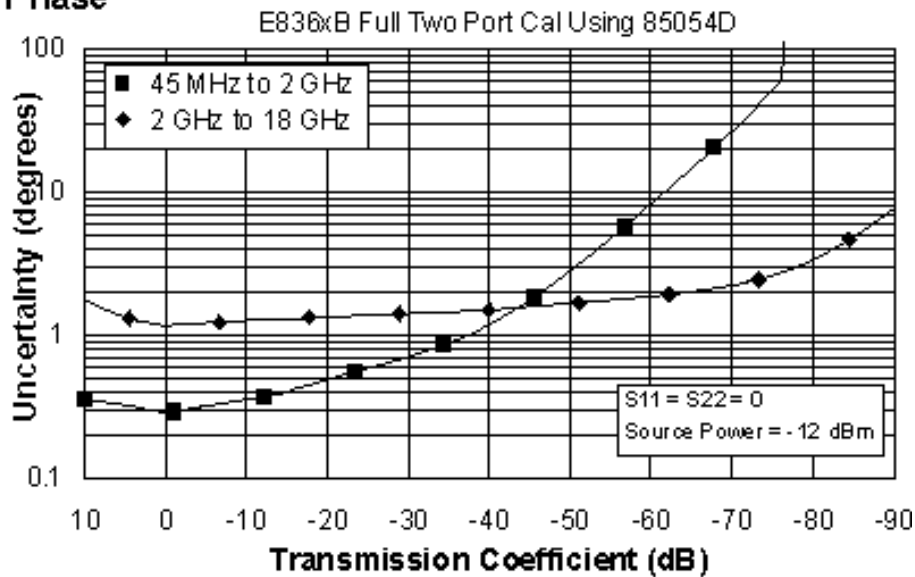

## Reflection Uncertainty (Specifications)

### Magnitude

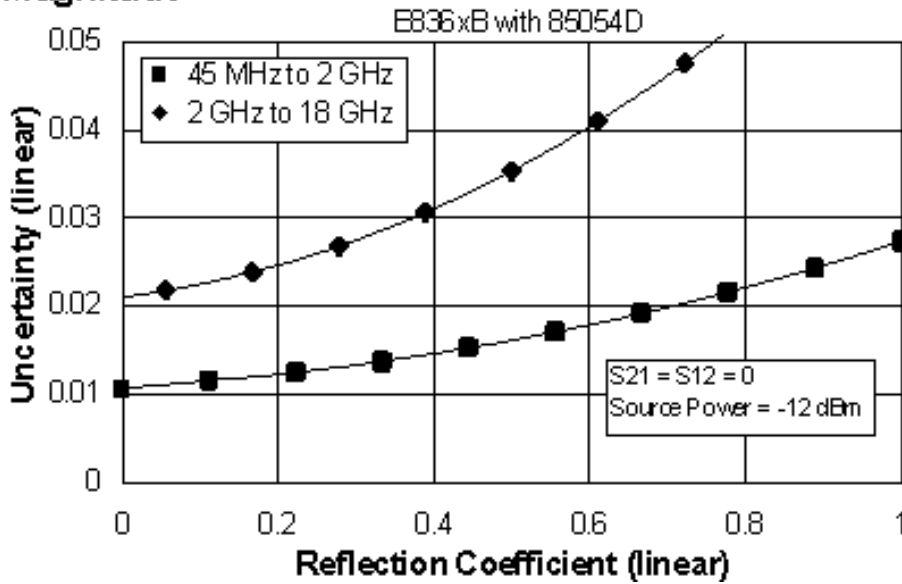

### Phase

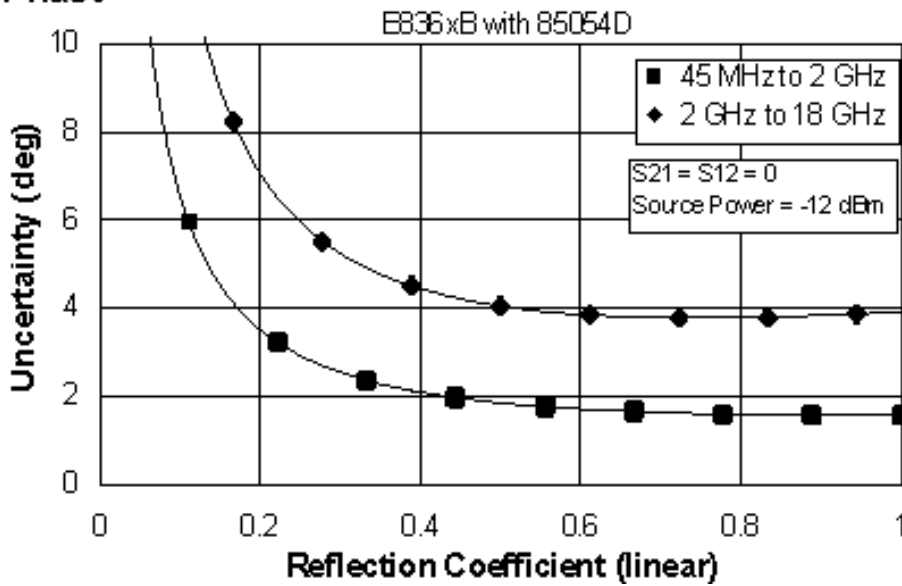

**Table 24.** 85054D Calibration Kit

Fully Optioned

Configurable Test Set, Extended Power Range & Bias-Tees, Receiver Attenuators, Frequency Offset Mode, and Reference Channel Transfer Switch

(E836xB - Option 014, UNL, 016, 080, and 081)

Applies to the, E836xB analyzers, 85054D (Type-N) calibration kit, 85132F flexible test port cable set with 85130C adapter set, and a full 2-port calibration. Also applies to the following condition:

Environmental temperature 23° ±3 °C, with < 1 °C deviation from calibration temperature

Description	Specification (dB)	
	0.045 to 2 GHz	2 to 18 GHz
Directivity	40	34
Source Match	39	29
Load Match	40	34
Reflection Tracking	±0.003 +0.02/°C	±0.027 +0.02/°C
Transmission Tracking	±0.025 +0.02/°C	±0.145 +0.02/°C

## Transmission Uncertainty (Specifications)

### Magnitude

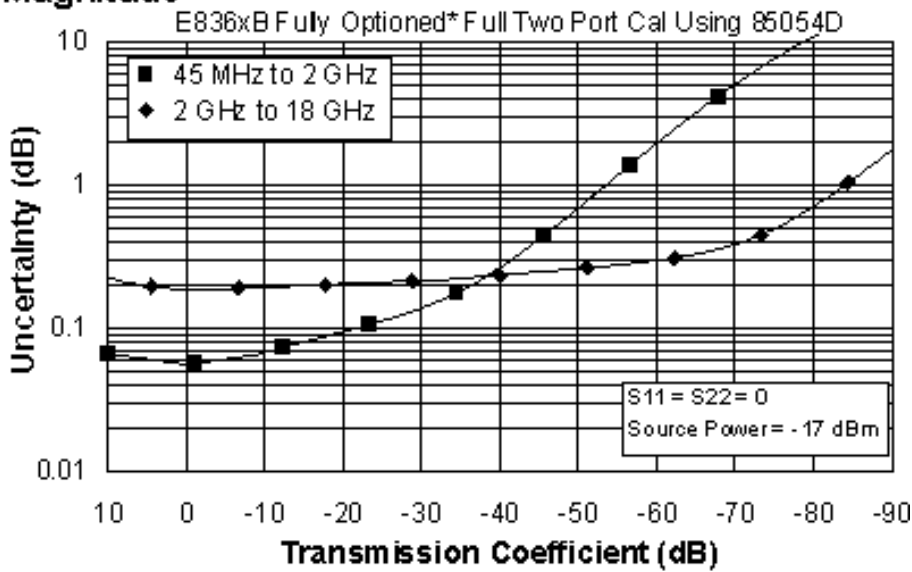

### Phase

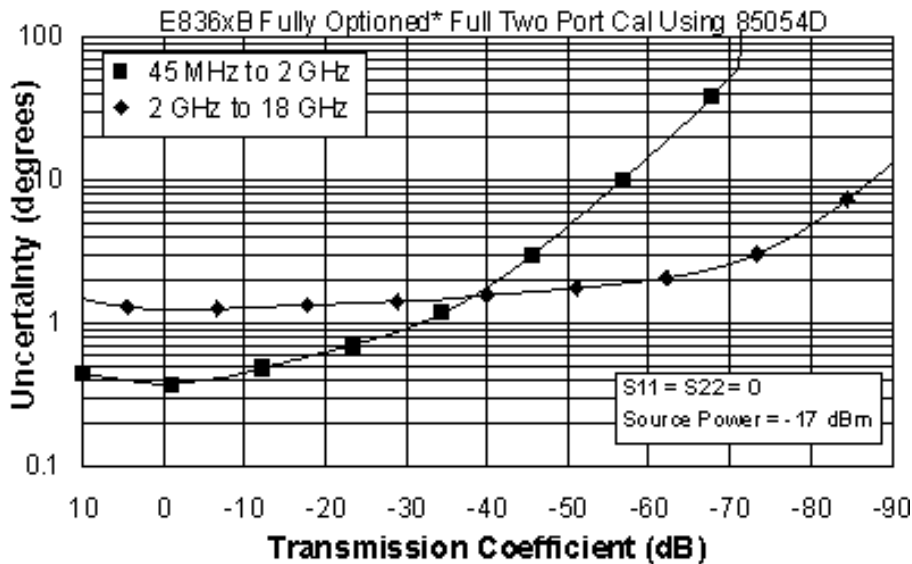

\* Configurable Test Set, Extended Power Range & Bias-Tees, Receiver Attenuators, Frequency Offset Mode, and Reference Channel Transfer Switch  
(E836xB - Option 014, UNL, 016, 080, and 081)

**Reflection Uncertainty (Specifications)**

**Magnitude**

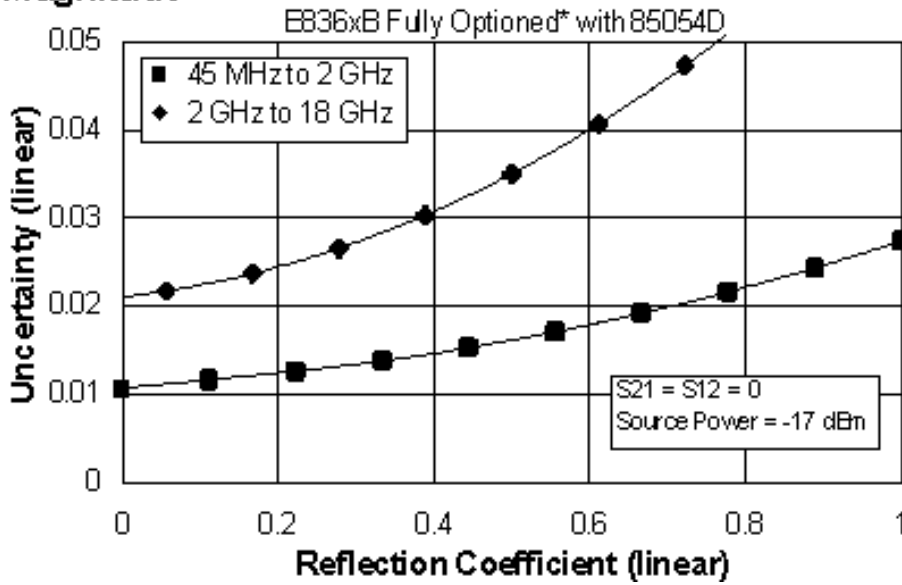

**Phase**

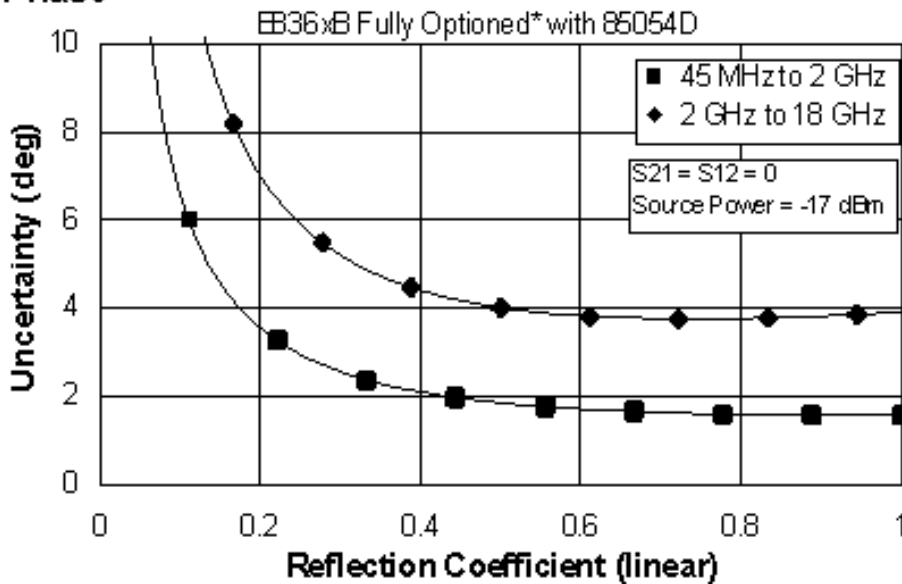

\* Configurable Test Set, Extended Power Range & Bias-Tees, Receiver Attenuators, Frequency Offset Mode, and Reference Channel Transfer Switch  
 (E836xB - Option 014, UNL, 016, 080, and 081)

**E8363/4B Corrected System Performance with WR-28 Connectors**

**R11644A Calibration Kit:**

**Table 25.** R11644A Calibration Kit  
Standard Configuration and Standard Power Range  
(E8363/4B)

Applies to the, E8363/4B analyzers, R11644A (WR-28) calibration kit, 85133F flexible test port cable set with the R281A and R281B launch sets with the R281A and R281B launch sets, and a full 2-port calibration. Also applies to the following condition:

Environmental temperature 23° ±3 °C, with < 1 °C deviation from calibration temperature

Description	Specification (dB)
	<b>26.5 to 40 GHz</b>
Directivity	50
Source Match	50
Load Match	50
Reflection Tracking	±0.000 +0.03/°C
Transmission Tracking	±0.018 +0.03/°C

## Transmission Uncertainty (Specifications)

### Magnitude

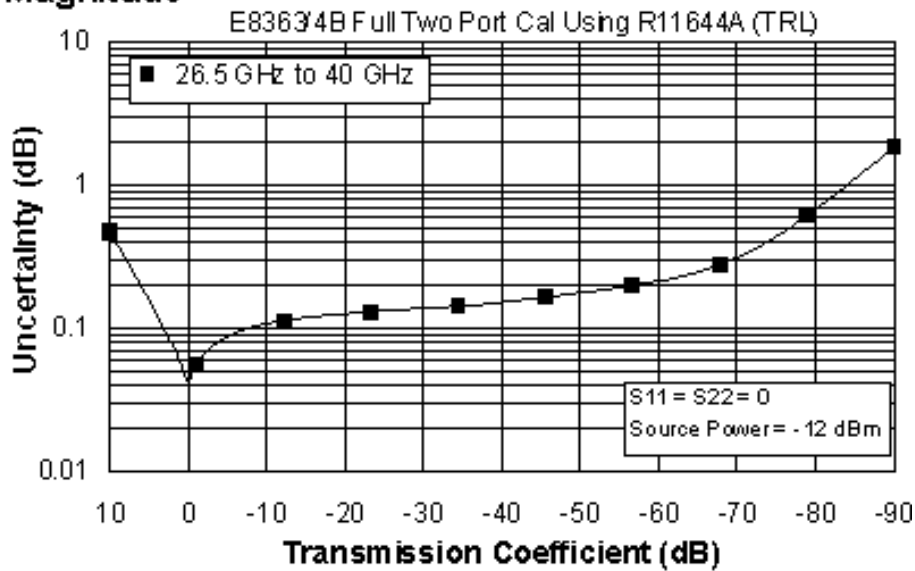

### Phase

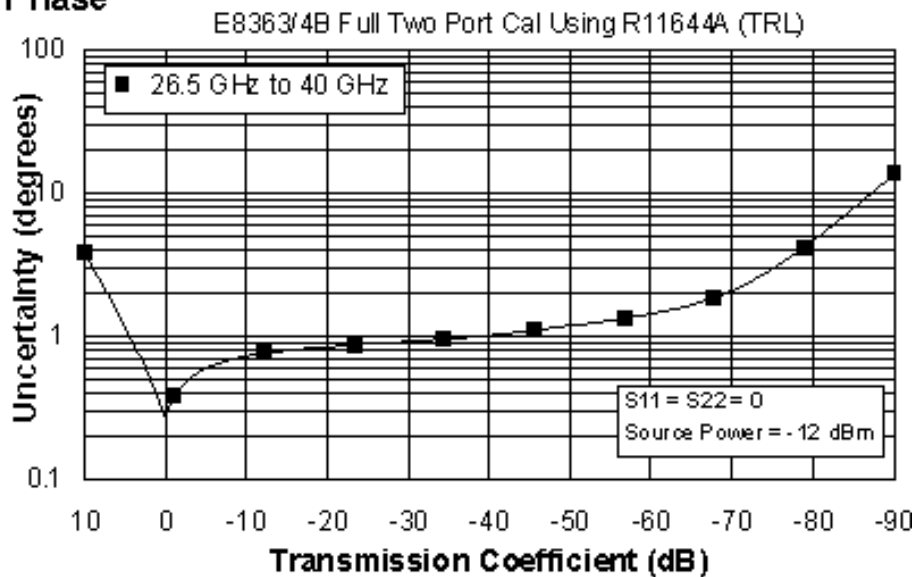

## Reflection Uncertainty (Specifications)

### Magnitude

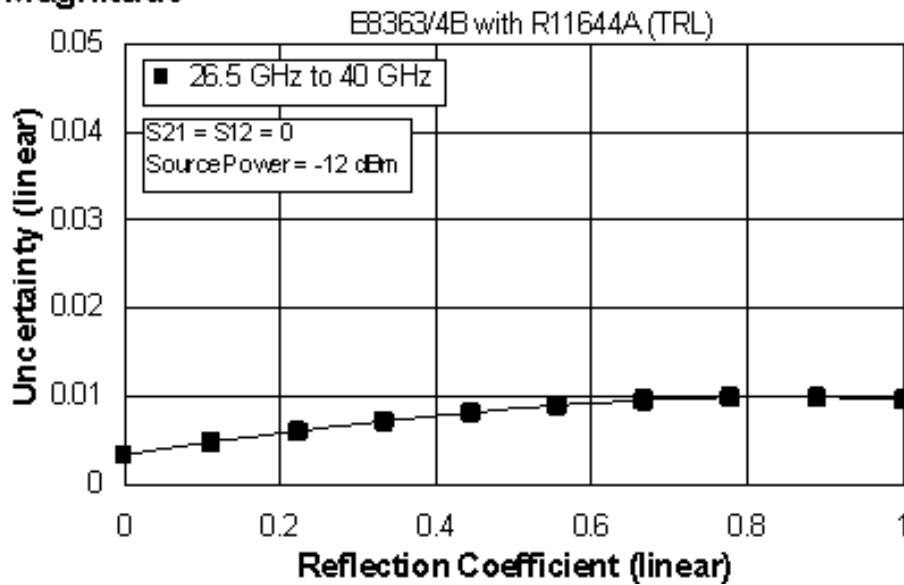

### Phase

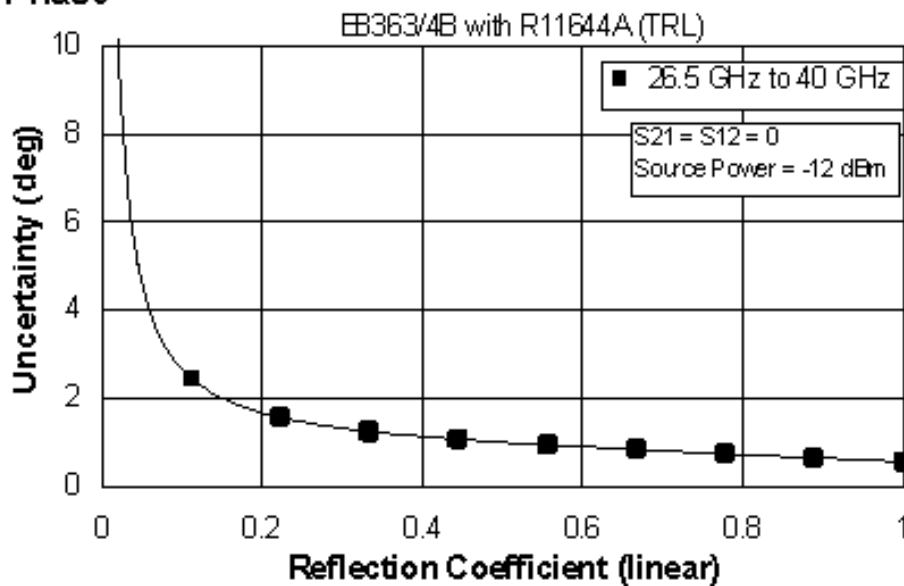



**Table 26. R11644A Calibration Kit**

Fully Optioned

Configurable Test Set, Extended Power Range & Bias-Tees, Receiver Attenuators, Frequency Offset Mode, and Reference Channel Transfer Switch

(E836xB - Option 014, UNL, 016, 080, and 081)

Applies to the, E8363/4B analyzers, R11644A (WR-28) calibration kit, 85133F flexible test port cable set with the R281A and R281B launch sets with the R281A and R281B launch sets, and a full 2-port calibration. Also applies to the following condition:

Environmental temperature 23° ±3 °C, with < 1 °C deviation from calibration temperature

Description	Specification (dB)
	<b>26.5 to 40 GHz</b>
Directivity	50
Source Match	50
Load Match	50
Reflection Tracking	±0.000 +0.03/°C
Transmission Tracking	±0.019 +0.03/°C

## Transmission Uncertainty (Specifications)

### Magnitude

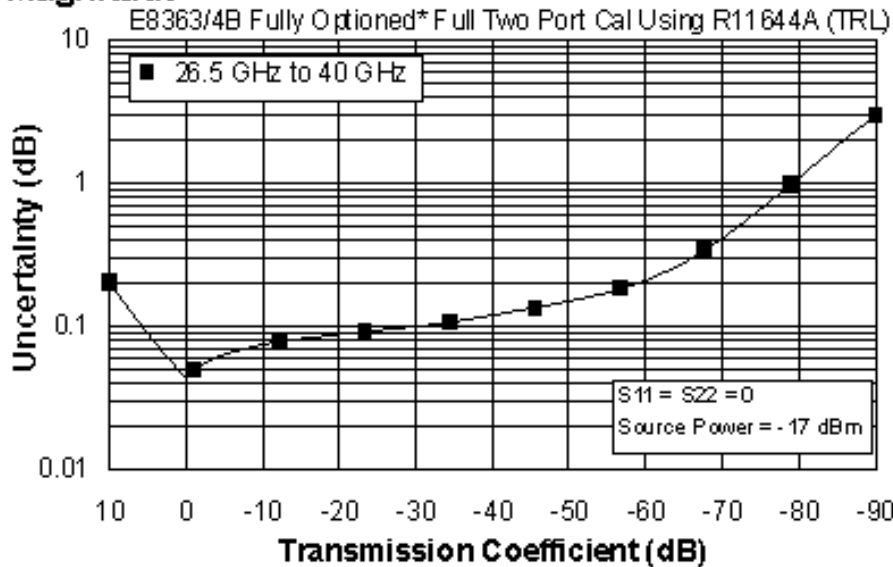

### Phase

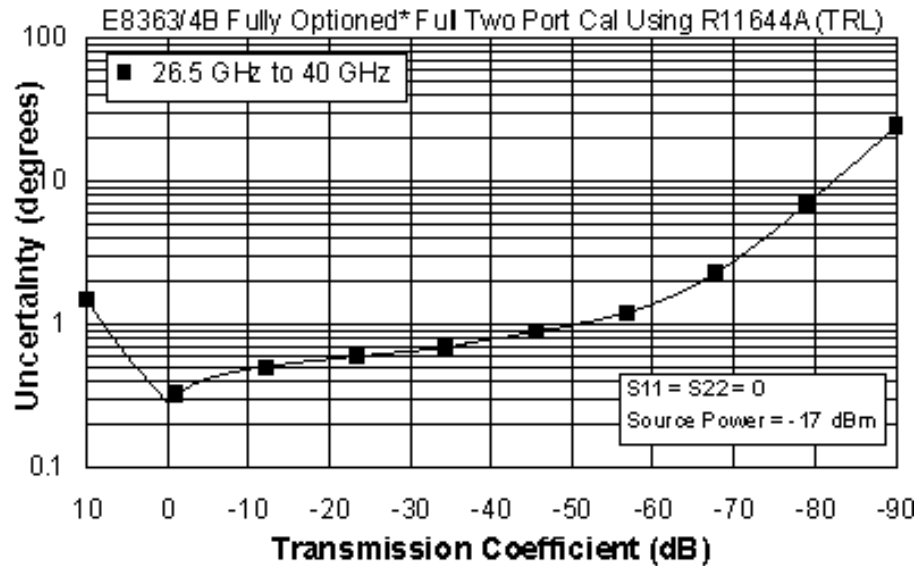

\* Configurable Test Set, Extended Power Range & Bias-Tees, Receiver Attenuators, Frequency Offset Mode, and Reference Channel Transfer Switch (E836xB - Option 014, UNL, 016, 080, and 081)

## Reflection Uncertainty (Specifications)

### Magnitude

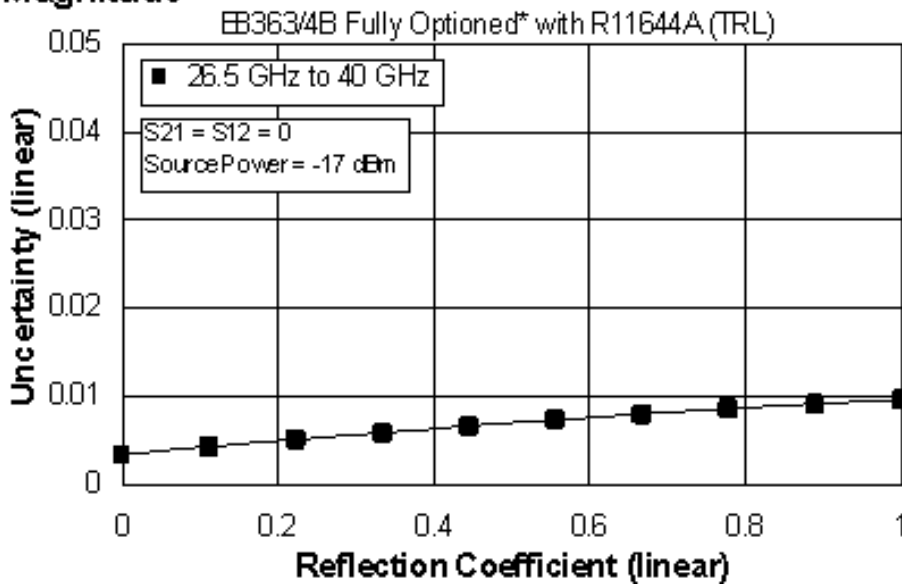

### Phase

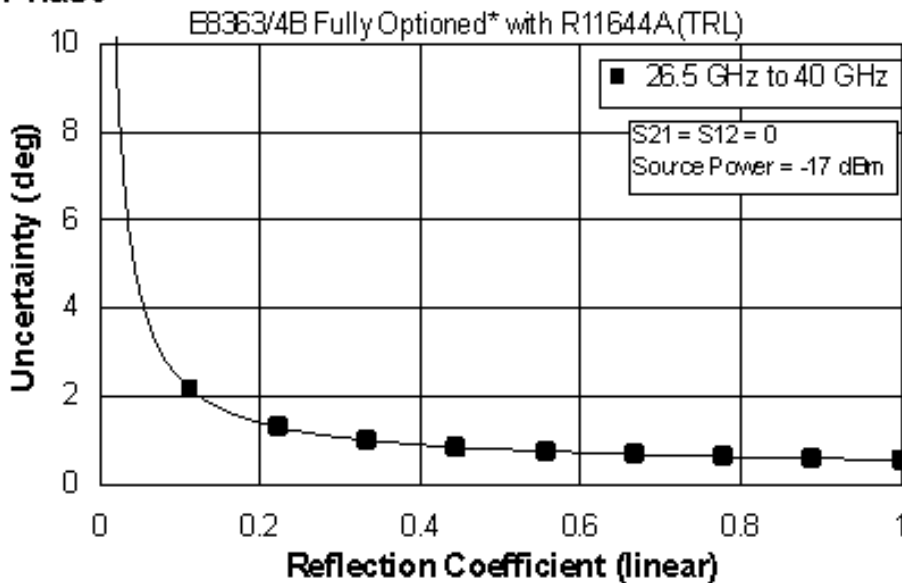

\* Configurable Test Set, Extended Power Range & Bias-Tees, Receiver Attenuators, Frequency Offset Mode, and Reference Channel Transfer Switch (E836xB - Option 014, UNL, 016, 080, and 081)

## E8363/4B Corrected System Performance with WR-42 Connectors

### K11644A Calibration Kit:

**Table 27.** K11644A Calibration Kit  
Standard Configuration and Standard Power Range  
(E8363/4B)

Applies to the, E8363/4B analyzers, K11644A (WR-42) calibration kit, 85134F flexible test port cable set, and a full 2-port calibration. Also applies to the following condition:

Environmental temperature  $23^{\circ} \pm 3^{\circ} \text{C}$ , with  $< 1^{\circ} \text{C}$  deviation from calibration temperature

Description	Specification (dB)	
	18 to 20 GHz	20 to 26.5 GHz
Directivity	50	50
Source Match	50	50
Load Match	50	50
Reflection Tracking	$\pm 0.000$ $+0.02/^{\circ}\text{C}$	$\pm 0.000$ $+0.02/^{\circ}\text{C}$
Transmission Tracking	$\pm 0.014$ $+0.02/^{\circ}\text{C}$	$\pm 0.018$ $+0.02/^{\circ}\text{C}$

## Transmission Uncertainty (Specifications)

### Magnitude

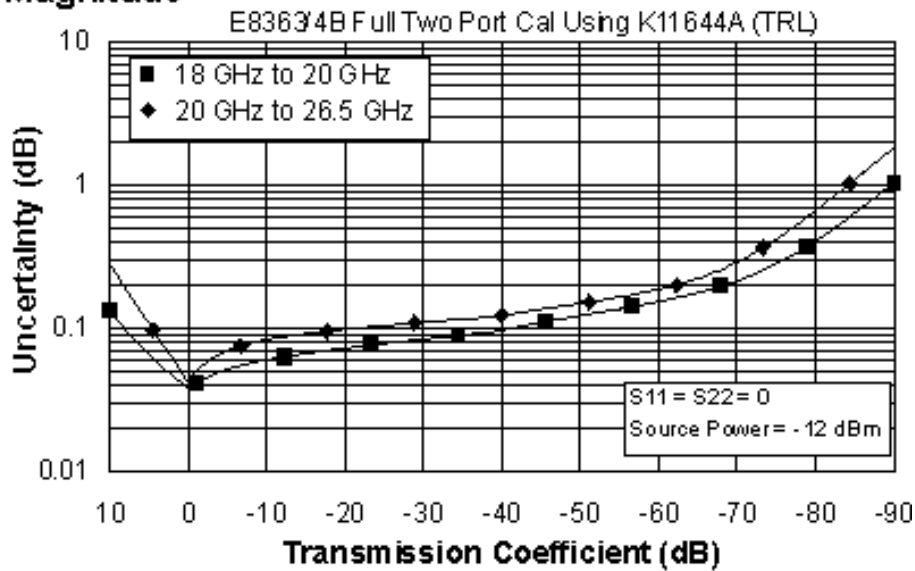

### Phase

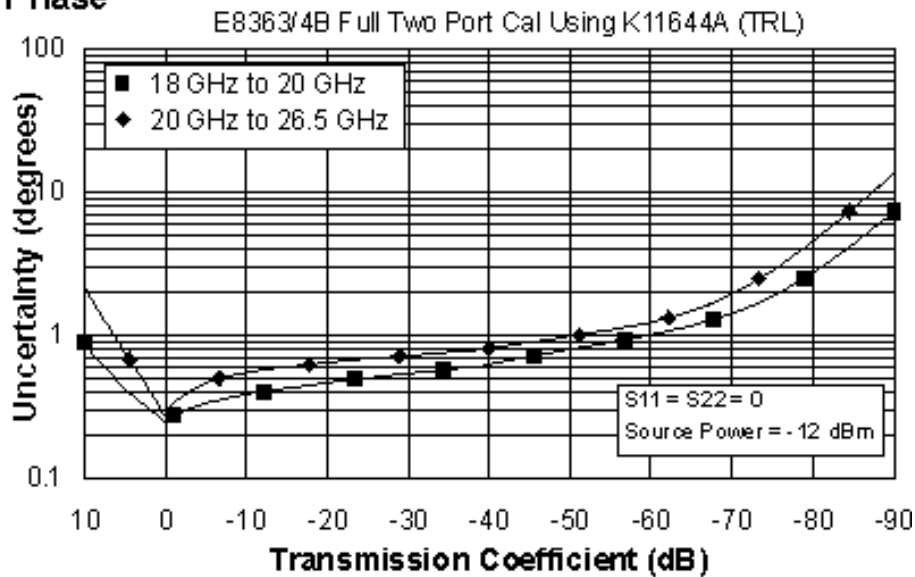

Reflection Uncertainty (Specifications)

Magnitude

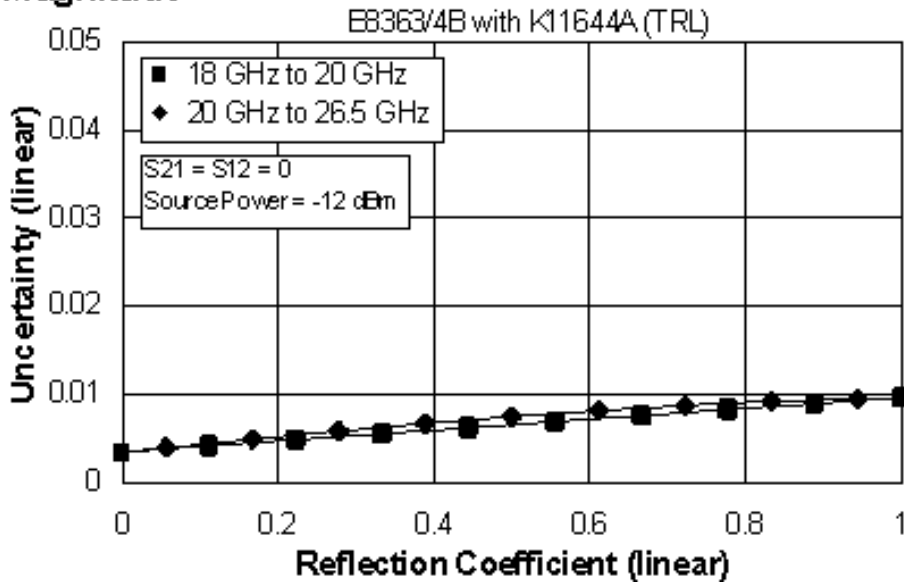

Phase

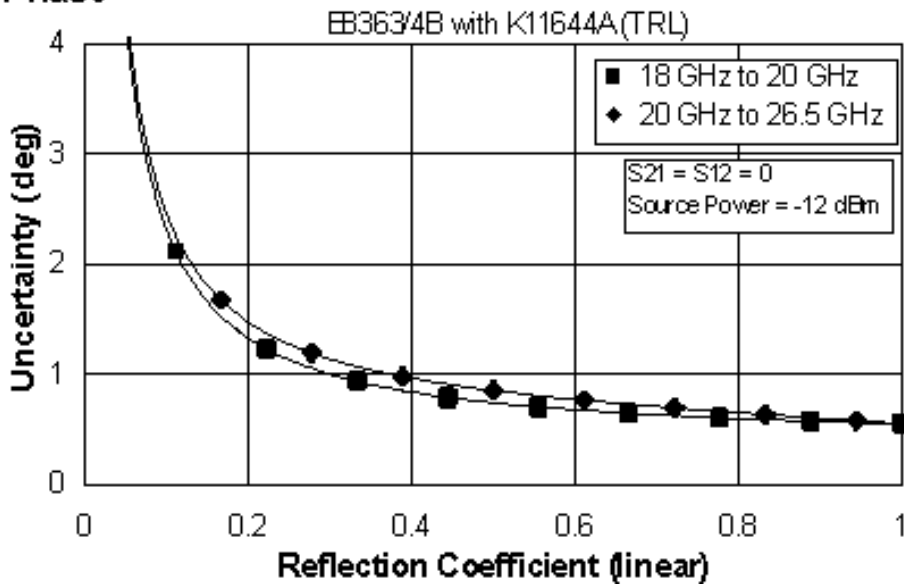

**Table 28.** K11644A Calibration Kit

Fully Optioned

Configurable Test Set, Extended Power Range & Bias-Tees, Receiver Attenuators, Frequency Offset Mode, and Reference Channel Transfer Switch

(E836xB - Option 014, UNL, 016, 080, and 081)

Applies to the, E8363/4B analyzers, K11644A (WR-42) calibration kit, 85134F flexible test port cable set, and a full 2-port calibration. Also applies to the following condition:

Environmental temperature 23° ±3 °C, with < 1 °C deviation from calibration temperature

Description	Specification (dB)	
	18 to 20 GHz	20 to 26.5 GHz
Directivity	50	50
Source Match	50	50
Load Match	50	50
Reflection Tracking	±0.000 +0.02/°C	±0.000 +0.02/°C
Transmission Tracking	±0.016 +0.02/°C	±0.019 +0.02/°C

## Transmission Uncertainty (Specifications)

### Magnitude

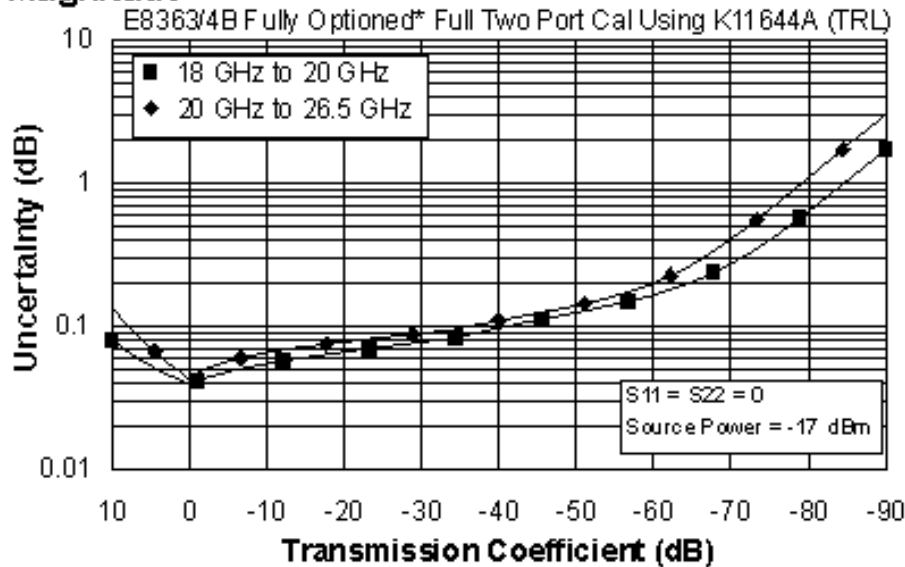

### Phase

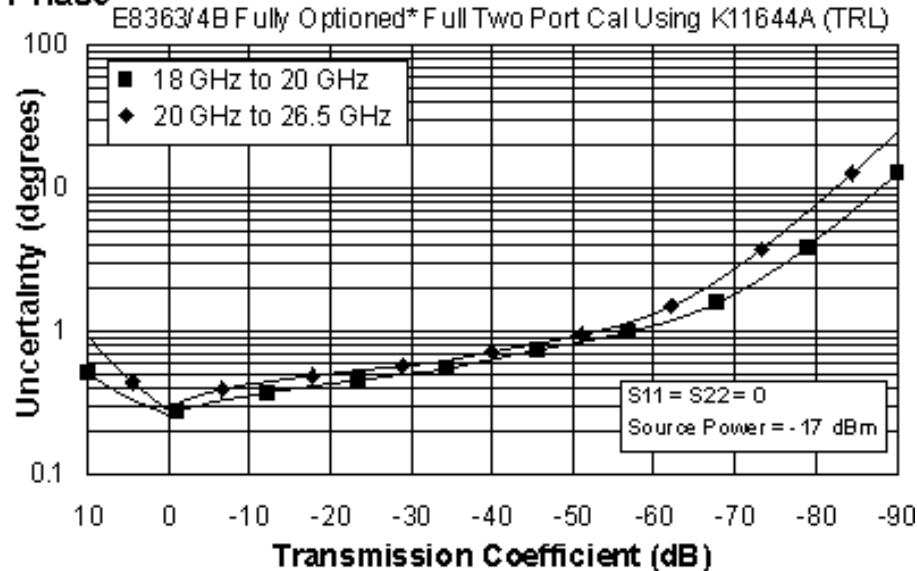

\* Configurable Test Set, Extended Power Range & Bias-Tees, Receiver Attenuators, Frequency Offset Mode, and Reference Channel Transfer Switch (E836xB - Option 014, UNL, 016, 080, and 081)



**Reflection Uncertainty (Specifications)**

**Magnitude**

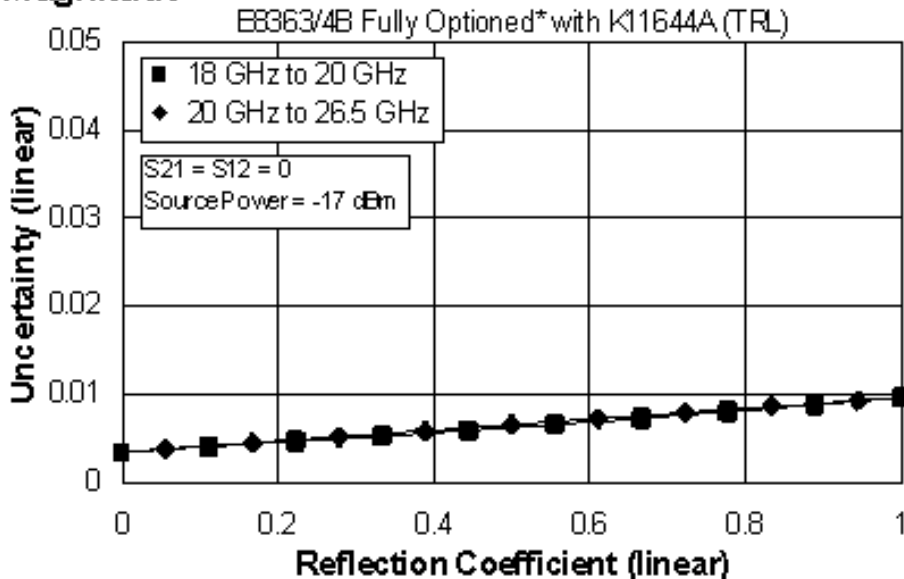

**Phase**

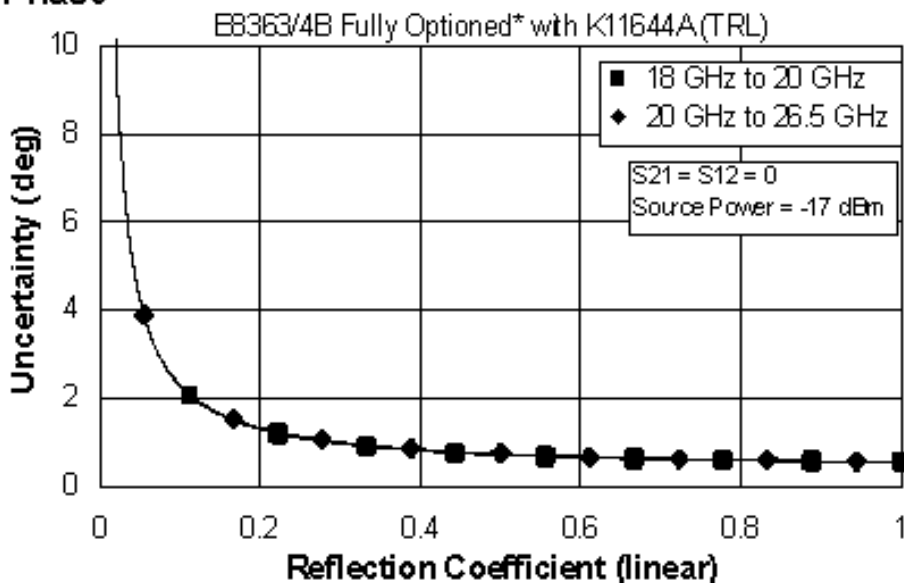

\* Configurable Test Set, Extended Power Range & Bias-Tees, Receiver Attenuators, Frequency Offset Mode, and Reference Channel Transfer Switch (E836xB - Option 014, UNL, 016, 080, and 081)

**E836xB Corrected System Performance with WR-62 Connectors**

**P11644A Calibration Kit:**

**Table 29.** P11644A Calibration Kit  
 Standard Configuration and Standard Power Range  
 (E836xB)

Applies to the, E836xB analyzers, R11644A (WR-62) calibration kit, 85132F flexible test port cable set, and a full 2-port calibration. Also applies to the following condition:

Environmental temperature 23° ±3 °C, with < 1 °C deviation from calibration temperature

<b>Description</b>	<b>Specification (dB)</b>
	<b>12.4 to</b>
	<b>18 GHz</b>
Directivity	50
Source Match	50
Load Match	50
Reflection Tracking	±0.000
	+0.02/°C
Transmission Tracking	±0.014
	+0.02/°C

## Transmission Uncertainty (Specifications)

### Magnitude

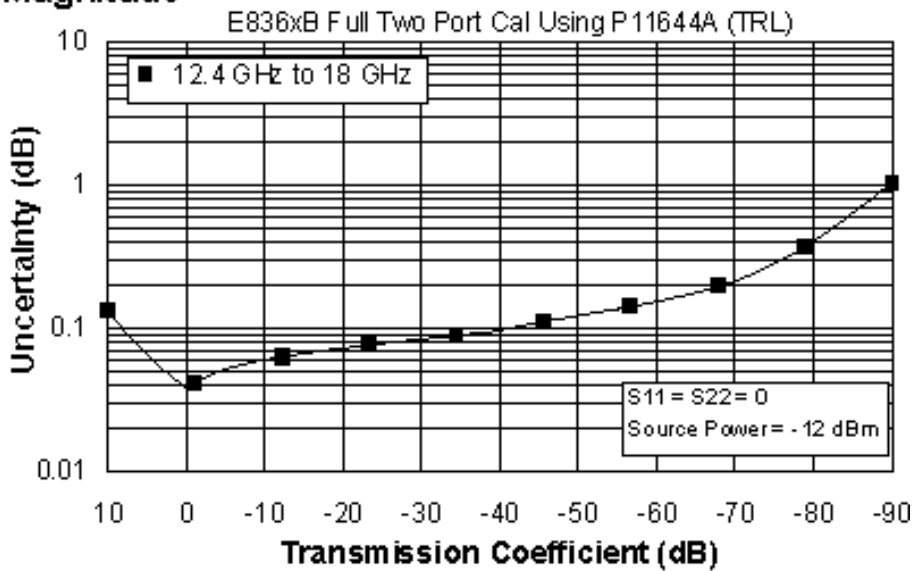

### Phase

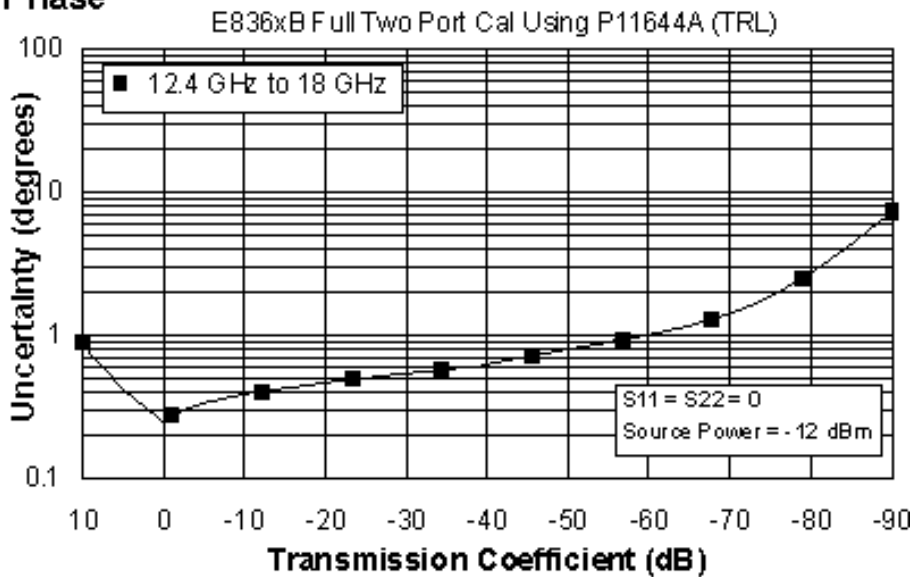

Reflection Uncertainty (Specifications)

Magnitude

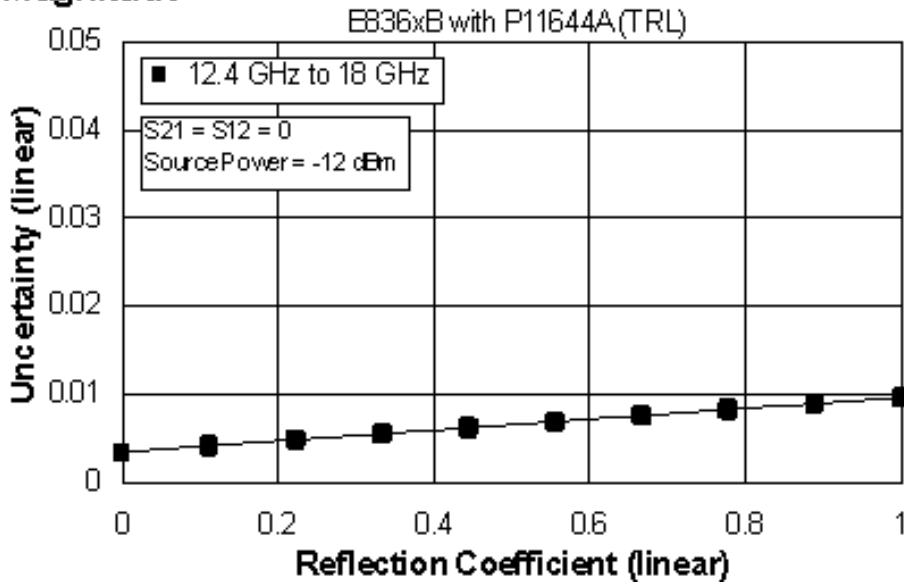

Phase

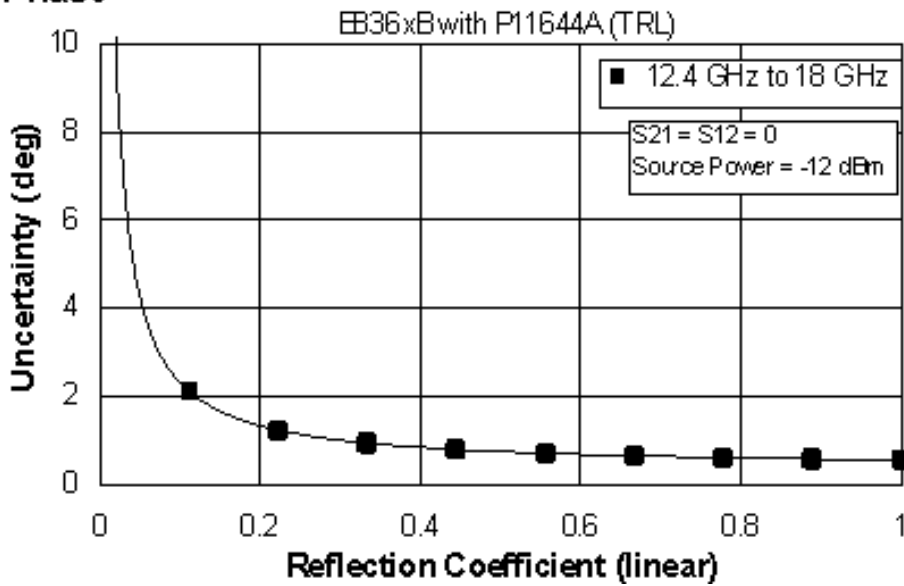

**Table 30.** P11644A Calibration Kit

Fully Optioned

Configurable Test Set, Extended Power Range & Bias-Tees, Receiver Attenuators, Frequency Offset Mode, and Reference Channel Transfer Switch

(E836xB - Option 014, UNL, 016, 080, and 081)

Applies to the, E836xB analyzers, P11644A (WR-62) calibration kit, 85132F flexible test port cable set, and a full 2-port calibration. Also applies to the following condition:

Environmental temperature 23° ±3 °C, with < 1 °C deviation from calibration temperature

Description	Specification (dB)
	<b>12.4 to 18 GHz</b>
Directivity	50
Source Match	50
Load Match	50
Reflection Tracking	±0.000 +0.02/°C
Transmission Tracking	±0.016 +0.02/°C

## Transmission Uncertainty (Specifications)

### Magnitude

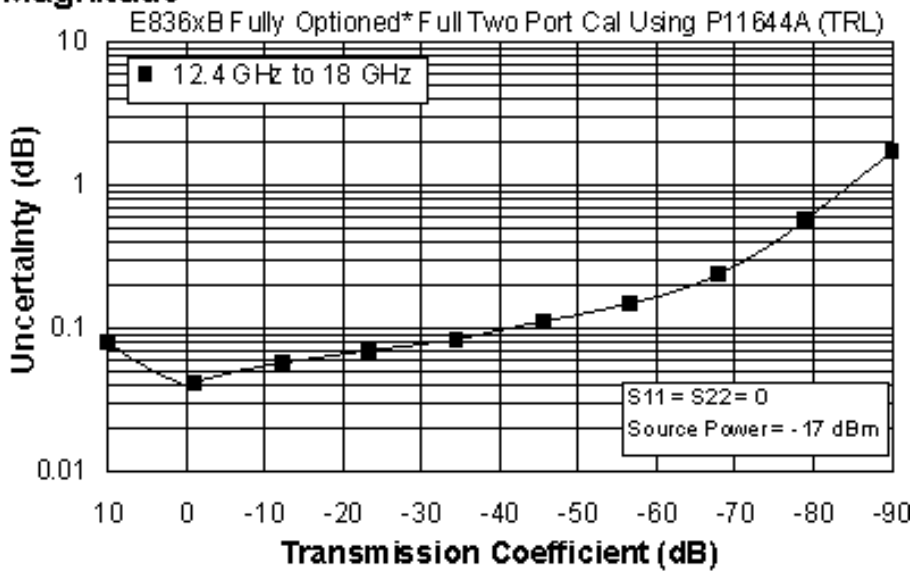

### Phase

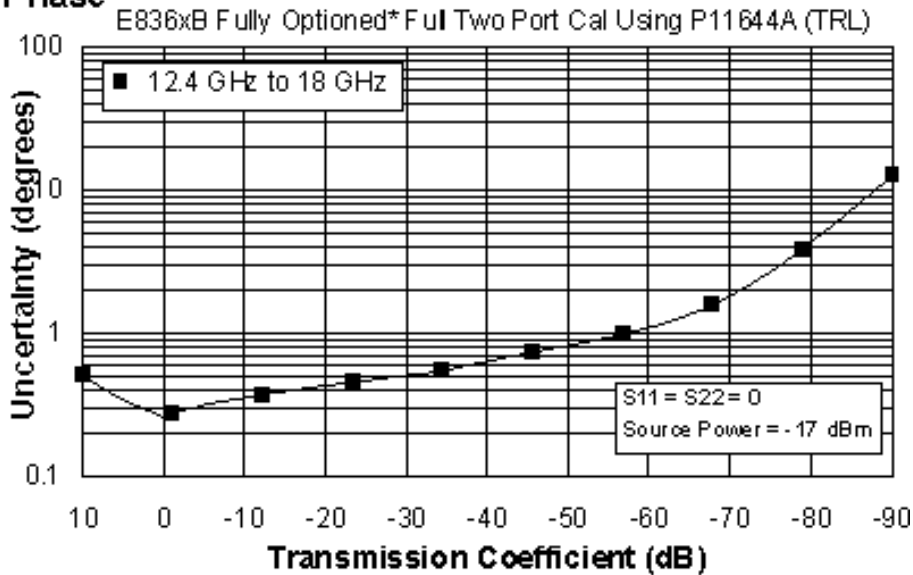

\* Configurable Test Set, Extended Power Range & Bias-Tees, Receiver Attenuators, Frequency Offset Mode, and Reference Channel Transfer Switch (E836xB - Option 014, UNL, 016, 080, and 081)

## Reflection Uncertainty (Specifications)

### Magnitude

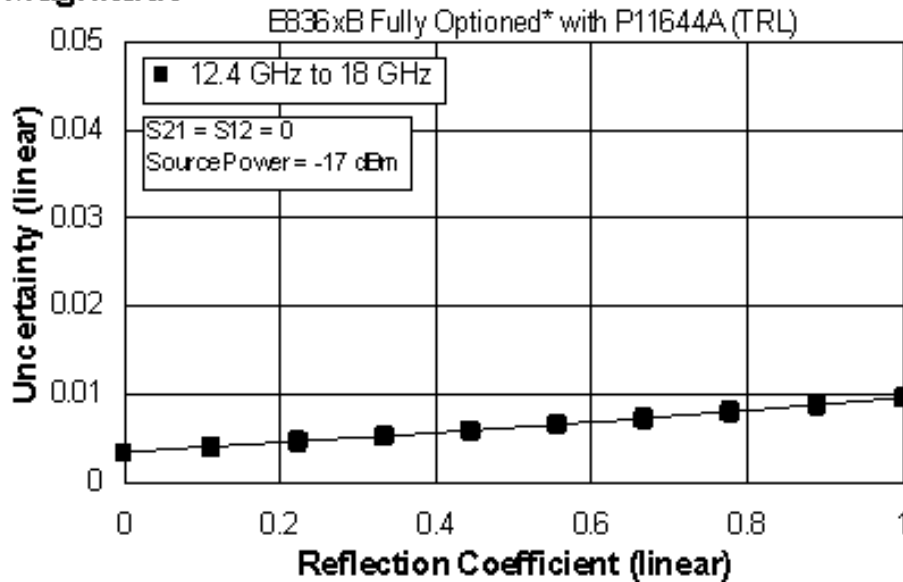

### Phase

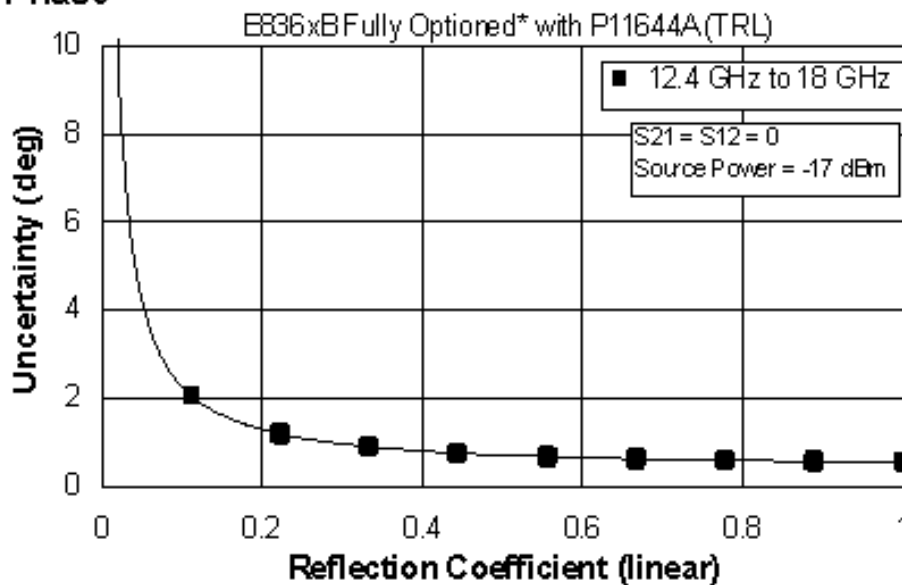

\* Configurable Test Set, Extended Power Range & Bias-Tees, Receiver Attenuators, Frequency Offset Mode, and Reference Channel Transfer Switch (E836xB - Option 014, UNL, 016, 080, and 081)

## E836xB Corrected System Performance with WR-90 Connectors

**Table 31.** X11644A Calibration Kit  
Standard Configuration and Standard Power Range  
(E836xB)

Applies to the, E836xB analyzers, X11644A (WR-90) calibration kit, 85133F flexible test port cable set, and a full 2-port calibration. Also applies to the following condition:

Environmental temperature  $23^{\circ} \pm 3^{\circ} \text{C}$ , with  $< 1^{\circ} \text{C}$  deviation from calibration temperature

<b>Description</b>	<b>Specification (dB)</b>
	<b>8.2 to 12.4 GHz</b>
Directivity	50
Source Match	50
Load Match	50
Reflection Tracking	$\pm 0.000$ $+0.02/^{\circ}\text{C}$
Transmission Tracking	$\pm 0.014$ $+0.02/^{\circ}\text{C}$



## Transmission Uncertainty (Specifications)

### Magnitude

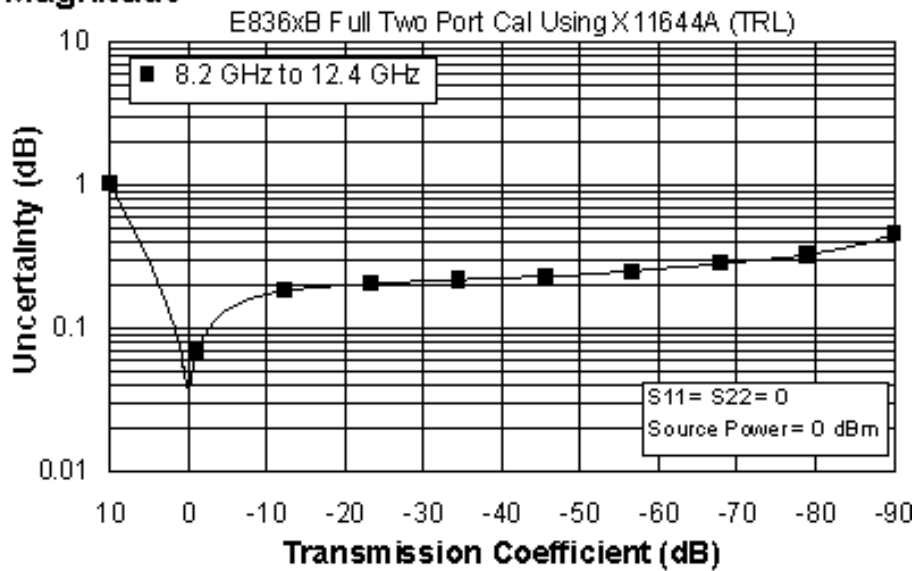

### Phase

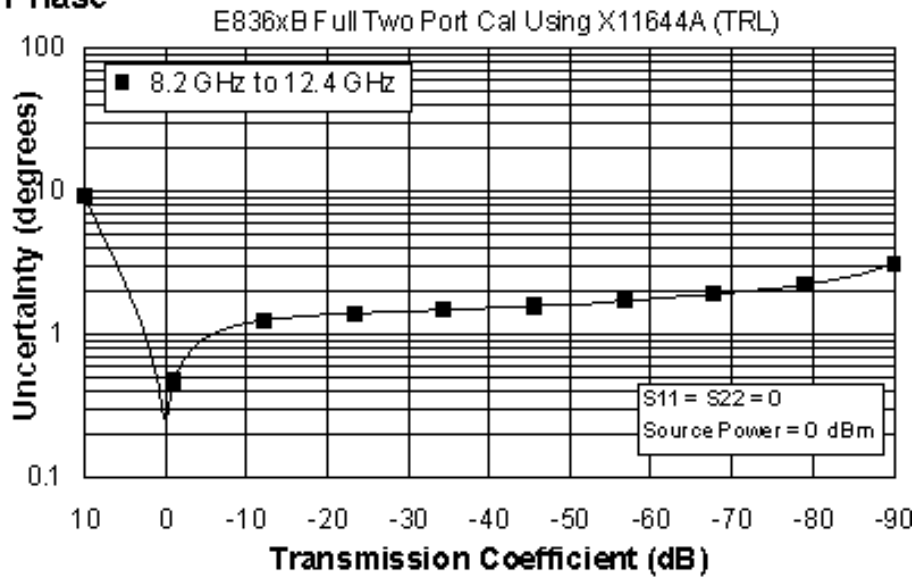

Reflection Uncertainty (Specifications)

Magnitude

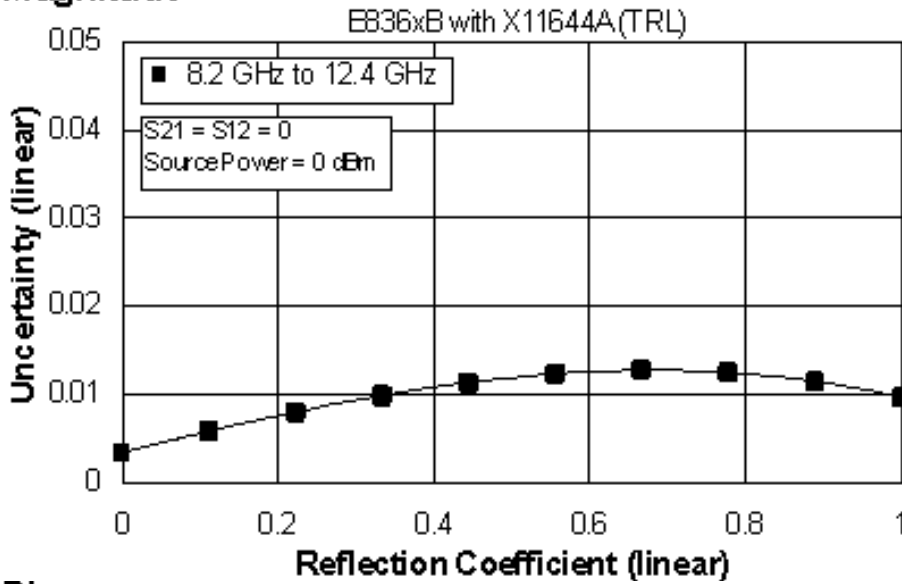

Phase

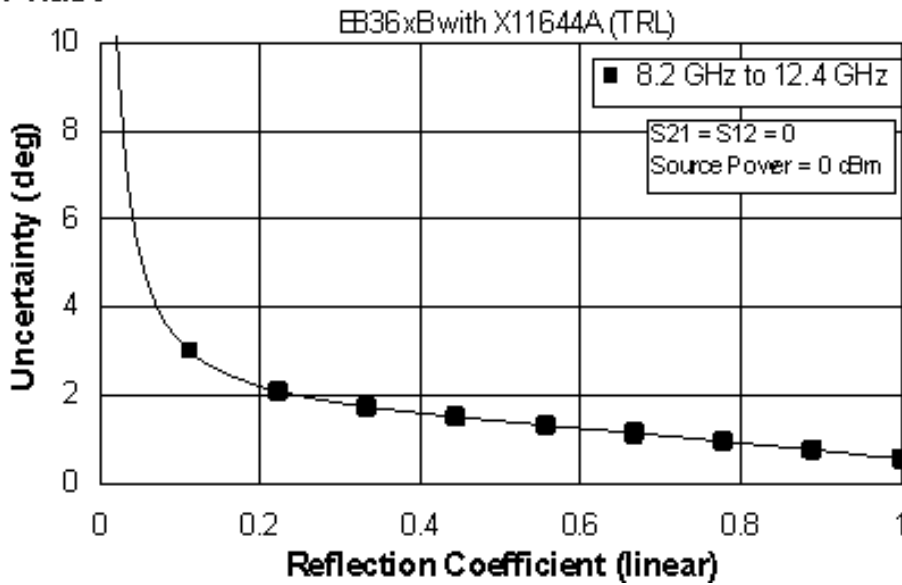

**Table 32.** X11644A Calibration Kit

Fully Optioned

Configurable Test Set, Extended Power Range & Bias-Tees, Receiver Attenuators, Frequency Offset Mode, and Reference Channel Transfer Switch

(E836xB - Option 014, UNL, 016, 080, and 081)

Applies to the, E836xB analyzers, X11644A (WR-90) calibration kit, 85133F flexible test port cable set, and a full 2-port calibration. Also applies to the following condition:

Environmental temperature 23° ±3 °C, with < 1 °C deviation from calibration temperature

Description	Specification (dB)
	<b>8.2 to 12.4 GHz</b>
Directivity	50
Source Match	50
Load Match	50
Reflection Tracking	±0.000 +0.02/°C
Transmission Tracking	±0.016 +0.02/°C

## Transmission Uncertainty (Specifications)

### Magnitude

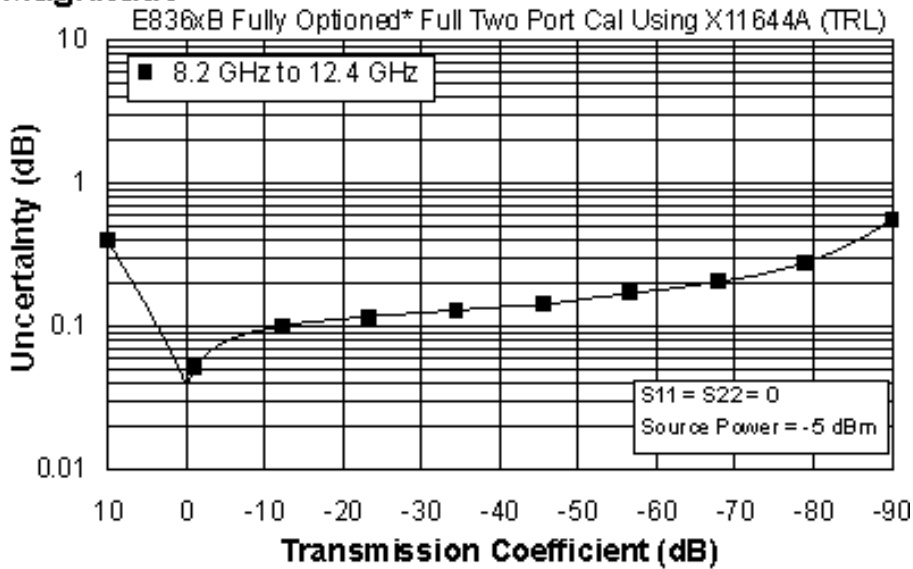

### Phase

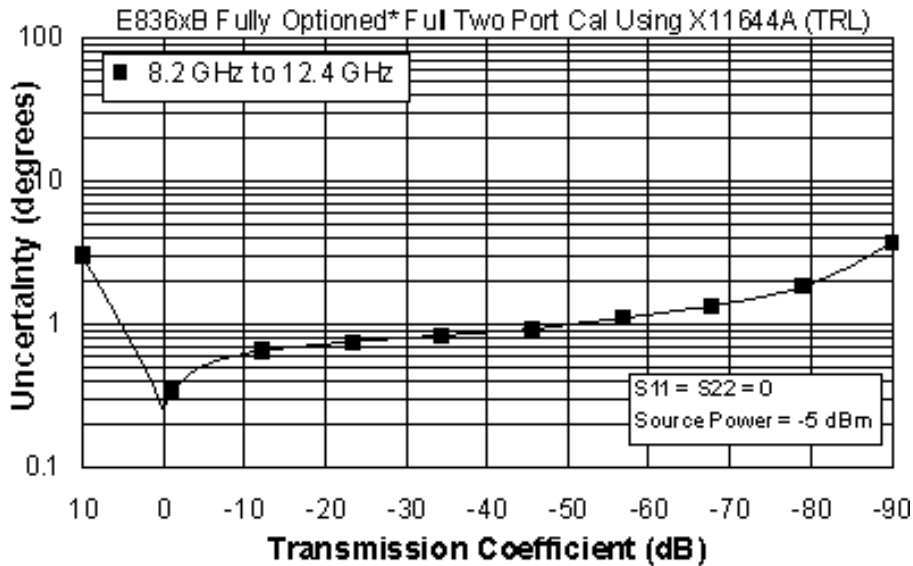

\* Configurable Test Set, Extended Power Range & Bias-Tees, Receiver Attenuators, Frequency Offset Mode, and Reference Channel Transfer Switch (E836xB - Option 014, UNL, 016, 080, and 081)

## Reflection Uncertainty (Specifications)

### Magnitude

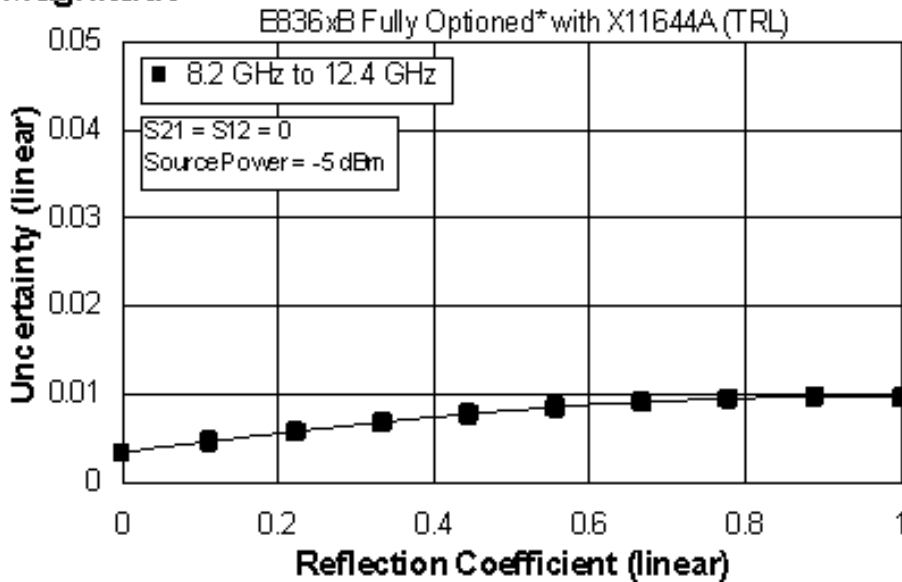

### Phase

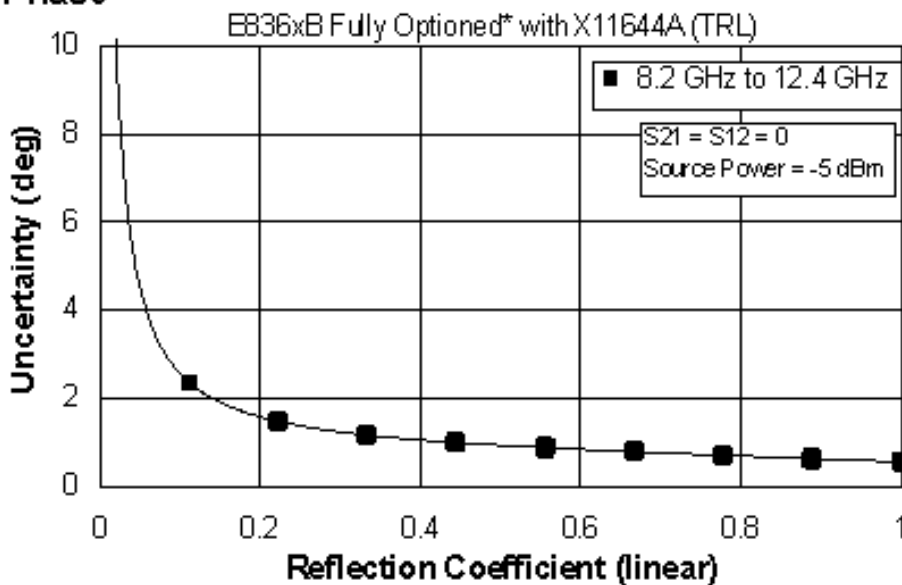

\* Configurable Test Set, Extended Power Range & Bias-Tees, Receiver Attenuators, Frequency Offset Mode, and Reference Channel Transfer Switch (E836xB - Option 014, UNL, 016, 080, and 081)

**Table 33. Uncorrected System Performance<sup>a</sup>**

Specifications apply over environmental temperature of 23° ±3 °C, with &lt; 1 °C deviation from the calibration temperature

Description	Specification	Supplemental Information
<b>Directivity</b>		
10 MHz to 45 MHz <sup>b</sup>	23 dB	
45 MHz to 2 GHz	24 dB	
2 GHz to 10 GHz	22 dB	
10 GHz to 20 GHz	16 dB	
20 GHz to 40 GHz	16 dB	
40 GHz to 45 GHz	15 dB	
45 GHz to 50 GHz	13 dB	
<b>Source Match - Standard</b>		
10 MHz to 45 MHz <sup>b</sup>	11 dB	
45 MHz to 2 GHz	23 dB	
2 GHz to 10 GHz	16 dB	
10 GHz to 20 GHz	14 dB	
20 GHz to 40 GHz	10 dB	
40 GHz to 45 GHz	9 dB	
45 GHz to 50 GHz	7.5 dB	
<b>Source Match - Opt UNL, 014 or 014/UNL</b>		
10 MHz to 45 MHz <sup>b</sup>	11 dB	
45 MHz to 2 GHz	18 dB	
2 GHz to 10 GHz	14 dB	
10 GHz to 20 GHz	12 dB	
20 GHz to 40 GHz	9 dB	
40 GHz to 45 GHz	8 dB	
45 GHz to 50 GHz	6 dB	
<b>Load Match - Standard</b>		
10 MHz to 45 MHz <sup>b</sup>	11 dB	
45 MHz to 2 GHz	23 dB	
2 GHz to 10 GHz	14 dB	
10 GHz to 20 GHz	10 dB	
20 GHz to 40 GHz	9 dB	
40 GHz to 45 GHz	9 dB	
45 GHz to 50 GHz	8 dB	
<b>Load Match - Opt UNL, 014 or 014/UNL</b>		
10 MHz to 45 MHz <sup>b</sup>	11 dB	
45 MHz to 2 GHz	17 dB	
2 GHz to 10 GHz	13 dB	
10 GHz to 20 GHz	10 dB	
20 GHz to 40 GHz	9 dB	
40 GHz to 45 GHz	9 dB	
45 GHz to 50 GHz	7 dB	
<b>Reflection Tracking</b>		
		<b>Typical:</b>
10 MHz to 45 MHz		±1.5 dB
45 MHz to 20 GHz		±1.5 dB
20 GHz to 40 GHz		±1.5 dB
40 GHz to 50 GHz		±2.0 dB

<b>Transmission Tracking<sup>c</sup></b>		
		<b>Typical:</b>
10 MHz to 45 MHz		±3.0 dB
45 MHz to 2 GHz		±1.5 dB
2 GHz to 10 GHz		±2.0 dB
10 GHz to 20 GHz		±2.5 dB
20 GHz to 40 GHz		±3.5 dB
40 GHz to 45 GHz		±4.0 dB
45 GHz to 50 GHz		±4.5 dB
<b>Crosstalk<sup>d</sup> - Standard</b>		
10 MHz to 45 MHz <sup>b</sup>	-65 dB	
45 MHz to 1 GHz	-85 dB	
1 GHz to 2 GHz	-100 dB	
2 GHz to 20 GHz	-110 dB	
20 GHz to 40 GHz	-108 dB	
40 GHz to 45 GHz	-105 dB	
45 GHz to 50 GHz	-100 dB	
<b>Crosstalk<sup>d</sup> - Option UNL or 014</b>		
10 MHz to 45 MHz <sup>b</sup>	-65 dB	
45 MHz to 1 GHz	-85 dB	
1 GHz to 2 GHz	-100 dB	
2 GHz to 20 GHz	-109 dB	
20 GHz to 40 GHz	-106 dB	
40 GHz to 45 GHz	-103 dB	
45 GHz to 50 GHz	-98 dB	
<b>Crosstalk<sup>d</sup> - Option 014/UNL</b>		
10 MHz to 45 MHz <sup>b</sup>	-65 dB	
45 MHz to 1 GHz	-85 dB	
1 GHz to 2 GHz	-98 dB	
2 GHz to 10 GHz	-108 dB	
10 GHz to 20 GHz	-107 dB	
20 GHz to 40 GHz	-104 dB	
40 GHz to 45 GHz	-100 dB	
45 GHz to 50 GHz	-95 dB	
<b>Crosstalk - Option 080 enabled<sup>b,e</sup></b>		
		<b>Typical:</b>
10 MHz to 45 MHz		-65
45 MHz to 1 GHz		-85
1 GHz to 2 GHz		-100
2 GHz to 10 GHz		-109
10 GHz to 20 GHz		-110
20 GHz to 40 GHz		-106
40 GHz to 45 GHz		-103
45 GHz to 50 GHz		-98

<sup>a</sup> Specifications apply over environment temperature of 23°C +/- 3°C, with less than 1°C deviation from the calibration temperature.

<sup>b</sup> Typical performance.

<sup>c</sup> Transmission tracking performance is strongly dependent on cable used. These typical specifications are based on the use of the Agilent thru cable (part number 85133-60016).

<sup>d</sup> Measurement conditions: normalized to a thru, measured with two shorts, 10 Hz IF bandwidth, averaging factor of 8, alternate mode, source power set to the lesser of the maximum power out or the maximum receiver power.

<sup>e</sup> 0 Hz offset.

Table 34. Test Port Output<sup>a</sup>

Description	Specification				Supplemental
<b>Frequency Range</b>					
	<b>Standard</b>	<b>Opt 014</b>	<b>Opt UNL</b>	<b>Opt 014/UNL</b>	
E8362B	10 MHz to 20 GHz				
E8363B	10 MHz to 40 GHz				
E8364B	10 MHz to 50 GHz				
<b>Nominal Power<sup>b</sup></b>					
E8362B	0 dBm	-5 dBm	-5 dBm	-5 dBm	
E8363/4B	-12 dBm	-17 dBm	-17 dBm	-17 dBm	
<b>Frequency Resolution</b>					
	1 Hz				
<b>CW Accuracy</b>					
	+/-1 ppm				
<b>Frequency Stability</b>					
					+/-1 ppm. 0° to 40° C, typical +/-0.2 ppm/yr, typical
<b>Power Level Accuracy</b>					
10 MHz to 45 MHz <sup>c</sup>	+/-2.0 dB	+/-2.0 dB	+/-2.0 dB	+/-2.0 dB	
45 MHz to 10 GHz	+/-1.5 dB	+/-1.5 dB	+/-1.5 dB	+/-1.5 dB	Variation from nominal power in range 0 (step attenuator at 0 dB)
10 GHz to 20 GHz	+/-2.0 dB	+/-2.0 dB	+/-2.0 dB	+/-2.0 dB	
20 GHz to 40 GHz	+/-3.0 dB	+/-3.0 dB	+/-3.0 dB	+/-3.0 dB	
40 GHz to 45 GHz	+/-3.0 dB	+/-3.5 dB	+/-3.0 dB	+/-3.5 dB	
45 GHz to 50 GHz	+/-3.0 dB	+/-4.0 dB	+/-3.0 dB	+/-4.0 dB	
<b>Power Level Linearity</b>					
10 MHz to 45 MHz <sup>c</sup>	+/-1.0 dB <sup>d</sup>	+/-1.0 dB <sup>d</sup>	+/-1.0 dB <sup>d</sup>	+/-1.0 dB <sup>d</sup>	Test reference is at the nominal power level (step attenuator at 0 dB)
45 MHz to 20 GHz	+/-1.0 dB <sup>d</sup>	+/-1.0 dB <sup>d</sup>	+/-1.0 dB <sup>d</sup>	+/-1.0 dB <sup>d</sup>	
20 GHz to 40 GHz	+/-1.0 dB <sup>d</sup>	+/-1.0 dB <sup>d</sup>	+/-1.0 dB <sup>d</sup>	+/-1.0 dB <sup>d</sup>	
40 GHz to 50 GHz	+/-1.0 dB	+/-1.0 dB	+/-1.0 dB	+/-1.0 dB	
<b>Power Range<sup>e</sup></b>					
10 MHz to 45 MHz <sup>c</sup>	-25 to +2 dBm	-25 to +2 dBm	-85 to +2 dBm	-85 to +2 dBm	
45 MHz to 10 GHz	-25 to +5 dBm	-25 to +5 dBm	-87 to +3 dBm	-87 to +3 dBm	
10 GHz to 20 GHz	-24 to +3 dBm	-25 to +2 dBm	-86 to +1 dBm	-87 to 0 dBm	
20 GHz to 30 GHz	-23 to 0 dBm	-25 to -2 dBm	-85 to -2 dBm	-87 to -4 dBm	
30 GHz to 40 GHz	-23 to -4 dBm	-25 to -6 dBm	-85 to -6 dBm	-87 to -8 dBm	
40 GHz to 45 GHz	-25 to -5 dBm	-27 to -7 dBm	-87 to -9 dBm	-87 to -11 dBm	
45 GHz to 50 GHz	-25 to -10 dBm	-27 to -12 dBm	-87 to -15 dBm	-87 to -17 dBm	



<b>Power Sweep Range (ALC)</b>					
10 MHz to 45 MHz <sup>c</sup>	27 dB	27 dB	27 dB	27 dB	ALC range starts at maximum leveled output power and decreases by power level indicated in the table.
45 MHz to 10 GHz	30 dB	30 dB	30 dB	30 dB	
10 GHz to 20 GHz	27 dB	27 dB	27 dB	27 dB	
20 GHz to 30 GHz	23 dB	23 dB	23 dB	23 dB	
30 GHz to 40 GHz	19 dB	19 dB	19 dB	19 dB	
40 GHz to 45 GHz	20 dB	20 dB	18 dB	16 dB	
45 GHz to 50 GHz	15 dB	15 dB	12 dB	10 dB	
<b>Power Resolution</b>					
	0.01 dB				
<b>Phase Noise</b>					
<b>1 kHz offset from center frequency, nominal power at test port</b>					
					<b>Typical:</b>
10 MHz to 10 GHz					-60 dBc
10 GHz to 20 GHz					-55 dBc
20 GHz to 50 GHz					-50 dBc
<b>1 kHz offset from center frequency, nominal power at test port - Option 080 enabled</b>					
					<b>Typical:</b>
10 MHz to 10 GHz					-60 dBc
10 GHz to 20 GHz					-60 dBc
20 GHz to 50 GHz					-50 dBc
<b>10 kHz offset from center frequency, nominal power at test port</b>					
					<b>Typical:</b>
10 MHz to 45 MHz					-70 dBc
45 MHz to 10 GHz					-70 dBc
10 GHz to 20 GHz					-65 dBc
20 GHz to 40 GHz					-55 dBc
40 GHz to 50 GHz					-55 dBc

<b>10 kHz offset from center frequency, nominal power at test port - Option 080 enabled</b>					
					<b>Typical:</b>
10 MHz to 45 MHz					-70 dBc
45 MHz to 10 GHz					-70 dBc
10 GHz to 20 GHz					-65 dBc
20 GHz to 40 GHz					-55 dBc
40 GHz to 50 GHz					-55 dBc
<b>100 kHz offset from center frequency, nominal power at test port</b>					
					<b>Typical:</b>
10 MHz to 10 GHz					-60 dBc
10 GHz to 20 GHz					-55 dBc
20 GHz to 50 GHz					-50 dBc
<b>100 kHz offset from center frequency, nominal power at test port - Option 080 enabled</b>					
					<b>Typical:</b>
10 MHz to 10 GHz					-75 dBc
10 GHz to 20 GHz					-70 dBc
20 GHz to 50 GHz					-65 dBc
<b>1 MHz offset from center frequency, nominal power at test port</b>					
					<b>Typical:</b>
10 MHz to 10 GHz					-106 dBc
10 GHz to 20 GHz					-103 dBc
20 GHz to 50 GHz					-90 dBc
<b>1 MHz offset from center frequency, nominal power at test port - Option 080 enabled</b>					
					<b>Typical:</b>
10 MHz to 10 GHz					-103 dBc
10 GHz to 20 GHz					-97 dBc
20 GHz to 50 GHz					-85 dBc
<b>Harmonics (2nd or 3rd)</b>					
					-23 dBc typical, in power range 0

Non-Harmonic Spurious (at Nominal Output Power)					
10 MHz to 45 MHz					-50 dBc typical, for offset frequency > 1 kHz
45 MHz to 20 GHz					-50 dBc typical, for offset frequency > 1 kHz
20 GHz to 40 GHz					-30 dBc typical, for offset frequency > 1 kHz
40 GHz to 50 GHz					-30 dBc typical, for offset frequency > 1 kHz

<sup>a</sup> Source output performance on Port 1 only. Port 2 output performance is typical.

<sup>b</sup> Preset power.

<sup>c</sup> Typical performance.

<sup>d</sup> 1.5 dB for power  $\leq -23$  dBm.

<sup>e</sup> Power to which the source can be set and phase lock is assured.

**Table 35:** Test Port Input

Description	Specification				Supplemental
	Standard	Opt 014	Opt UNL	Opt 014/UNL	
<b>Test Port Noise Floor<sup>a</sup></b>					
<b>10 Hz IF Bandwidth</b>					
10 MHz to 45 MHz <sup>b</sup>	<-77 dBm	<-77 dBm	<-77 dBm	<-77 dBm	
45 MHz to 500 MHz <sup>c</sup>	<-89 dBm	<-89 dBm	<-89 dBm	<-89 dBm	
500 MHz to 2 GHz	<-114 dBm	<-114 dBm	<-114 dBm	<-114 dBm	
2 GHz to 10 GHz	<-117 dBm	<-117 dBm	<-117 dBm	<-117 dBm	
10 GHz to 20 GHz	<-120 dBm	<-119 dBm	<-120 dBm	<-119 dBm	
20 GHz to 40 GHz	<-114 dBm	<-113 dBm	<-114 dBm	<-113 dBm	Option 016 degrades performance by 2 dB.
40 GHz to 50 GHz	<-114 dBm	<-112 dBm	<-114 dBm	<-112 dBm	
<b>1 KHz IF Bandwidth</b>					
10 MHz to 45 MHz <sup>b</sup>	<-57 dBm	<-57 dBm	<-57 dBm	<-57 dBm	
45 MHz to 500 MHz <sup>c</sup>	<-69 dBm	<-69 dBm	<-69 dBm	<-69 dBm	
500 MHz to 2 GHz	<-94 dBm	<-94 dBm	<-94 dBm	<-94 dBm	
2 GHz to 10 GHz	<-97 dBm	<-97 dBm	<-97 dBm	<-97 dBm	
10 GHz to 20 GHz	<-100 dBm	<-99 dBm	<-100 dBm	<-99 dBm	
20 GHz to 40 GHz	<-94 dBm	<-93 dBm	<-94 dBm	<-93 dBm	Option 016 degrades performance by 2 dB.
40 GHz to 50 GHz	<-94 dBm	<-92 dBm	<-94 dBm	<-92 dBm	

<b>Test Port Noise Floor<sup>a,b</sup> Option 080 enabled<sup>d</sup></b>					
<b>10 Hz IF Bandwidth</b>					
10 MHz to 45 MHz <sup>b</sup>	<-77 dBm	<-77 dBm	<-77 dBm	<-77 dBm	
45 MHz to 500 MHz <sup>c</sup>	<-88 dBm	<-88 dBm	<-88 dBm	<-88 dBm	
500 MHz to 2 GHz	<-113 dBm	<-113 dBm	<-113 dBm	<-113 dBm	
2 GHz to 10 GHz	<-116 dBm	<-116 dBm	<-116 dBm	<-116 dBm	
10 GHz to 20 GHz	<-118 dBm	<-118 dBm	<-118 dBm	<-118 dBm	
20 GHz to 40 GHz	<-112 dBm	<-112 dBm	<-112 dBm	<-112 dBm	Option 016 degrades performance by 2 dB.
40 GHz to 50 GHz	<-111 dBm	<-111 dBm	<-111 dBm	<-111 dBm	
<b>1 KHz IF Bandwidth</b>					
10 MHz to 45 MHz <sup>b</sup>	<-57 dBm	<-57 dBm	<-57 dBm	<-57 dBm	
45 MHz to 500 MHz <sup>c</sup>	<-68 dBm	<-68 dBm	<-68 dBm	<-68 dBm	
500 MHz to 2 GHz	<-93 dBm	<-93 dBm	<-93 dBm	<-93 dBm	
2 GHz to 10 GHz	<-96 dBm	<-96 dBm	<-96 dBm	<-96 dBm	
10 GHz to 20 GHz	<-98 dBm	<-98 dBm	<-98 dBm	<-98 dBm	
20 GHz to 40 GHz	<-92 dBm	<-92 dBm	<-92 dBm	<-92 dBm	Option 016 degrades performance by 2 dB.
40 GHz to 50 GHz	<-91 dBm	<-91 dBm	<-91 dBm	<-91 dBm	

<b>Direct Receiver Access Input Noise Floor<sup>a,b</sup></b>					
<b>10 Hz IF Bandwidth</b>					
10 MHz to 45 MHz		<-127 dBm		<-127 dBm	
45 MHz to 500 MHz <sup>c</sup>		<-127 dBm		<-127 dBm	
500 MHz to 2 GHz		<-133 dBm		<-133 dBm	
2 GHz to 10 GHz		<-132 dBm		<-132 dBm	
10 GHz to 20 GHz		<-134 dBm		<-134 dBm	
20 GHz to 40 GHz		<-125 dBm		<-125 dBm	Option 016 degrades performance by 2 dB.
40 GHz to 50 GHz		<-123 dBm		<-123 dBm	
<b>1 KHz IF Bandwidth</b>					
10 MHz to 45 MHz		<-107 dBm		<-107 dBm	
45 MHz to 500 MHz <sup>c</sup>		<-107 dBm		<-107 dBm	
500 MHz to 2 GHz		<-113 dBm		<-113 dBm	
2 GHz to 10 GHz		<-112 dBm		<-112 dBm	
10 GHz to 20 GHz		<-114 dBm		<-114 dBm	
20 GHz to 40 GHz		<-105 dBm		<-105 dBm	Option 016 degrades performance by 2 dB.
40 GHz to 50 GHz		<-103 dBm		<-103 dBm	
<b>Direct Receiver Access Input Noise Floor<sup>a,b</sup> - Option 080 enabled<sup>d</sup></b>					
<b>10 Hz IF Bandwidth</b>					
10 MHz to 45 MHz		<-127 dBm		<-127 dBm	
45 MHz to 500 MHz <sup>c</sup>		<-126 dBm		<-126 dBm	
500 MHz to 2 GHz		<-132 dBm		<-132 dBm	
2 GHz to 10 GHz		<-131 dBm		<-131 dBm	
10 GHz to 20 GHz		<-133 dBm		<-133 dBm	
20 GHz to 40 GHz		<-124 dBm		<-124 dBm	Option 016 degrades performance by 2 dB.
40 GHz to 50 GHz		<-122 dBm		<-122 dBm	

<b>1 KHz IF Bandwidth</b>					
10 MHz to 45 MHz		<-107 dBm		<-107 dBm	
45 MHz to 500 MHz <sup>c</sup>		<-106 dBm		<-106 dBm	
500 MHz to 2 GHz		<-112 dBm		<-112 dBm	
2 GHz to 10 GHz		<-111 dBm		<-111 dBm	
10 GHz to 20 GHz		<-113 dBm		<-113 dBm	
20 GHz to 40 GHz		<-104 dBm		<-104 dBm	Option 016 degrades performance by 2 dB.
40 GHz to 50 GHz		<-102 dBm		<-102 dBm	
<b>Receiver Compression Level</b>					
10 MHz to 45 MHz <sup>b</sup>	<0.45 dB compression at +5 dBm				
45 MHz to 20 GHz	<0.45 dB compression at +5 dBm				
20 GHz to 30 GHz	<0.45 dB compression at 0 dBm				
30 GHz to 40 GHz	<0.45 dB compression at -3 dBm				
40 GHz to 50 GHz	<0.45 dB compression at -3 dBm				
<b>System Compression Level</b>					
	maximum output power				See <a href="#">dynamic accuracy table</a>
<b>Third Order Intercept - Tone spacing from 100 kHz - 5 MHz</b>					
					<b>Typical</b>
10 MHz to 150 MHz					+38 dBm
150 MHz to 300 MHz					+34 dBm
300 MHz to 500 MHz					+30 dBm
500 MHz to 20 GHz					+22 dBm with two -7 dBm tones
20 to 40 GHz					+18 dBm with two -15 dBm tones
40 to 50 GHz					+15 dBm with two -21 dBm tones

<b>Third Order Intercept - Tone spacing from 5 MHz - 20 MHz</b>		
		<b>Typical</b>
10 MHz to 500 MHz		+20 dBm with two -7 dBm tones
500 MHz to 20 GHz		+20 dBm with two -7 dBm tones
20 to 40 GHz		+15 dBm with two -15 dBm tones
40 to 50 GHz		+15 dBm with two -21 dBm tones
<b>Third Order Intercept - Tone spacing from 20 MHz - 50 MHz</b>		
		<b>Typical</b>
10 MHz to 500 MHz		+24 dBm with two -7 dBm tones
500 MHz to 20 GHz		+24 dBm with two -7 dBm tones
20 to 40 GHz		+20 dBm with two -15 dBm tones
40 to 50 GHz		+20 dBm with two -21 dBm tones
<b>Trace Noise Magnitude</b>		
1 kHz IF bandwidth. Ratio measurement, nominal power at test port.		
10 MHz to 45 MHz <sup>b</sup>	<0.050 dB rms	
45 MHz to 500 MHz <sup>e</sup>	<0.010 dB rms	
500 MHz to 20 GHz	<0.006 dB rms	
20 GHz to 40 GHz	<0.006 dB rms	
40 GHz to 50 GHz	<0.006 dB rms	



<b>Trace Noise Magnitude - Option 080 enabled<sup>b,d</sup></b>		
1 kHz IF bandwidth. Ratio measurement, nominal power at test port.		
10 MHz to 45 MHz <sup>b</sup>	<0.060 dB rms	
45 MHz to 500 MHz <sup>e</sup>	<0.010 dB rms	
500 MHz to 20 GHz	<0.006 dB rms	
20 GHz to 40 GHz	<0.007 dB rms	
40 GHz to 50 GHz	<0.008 dB rms	
<b>Trace Noise Phase</b>		
1 kHz IF bandwidth. Ratio measurement, nominal power at test port.		
10 MHz to 45 MHz <sup>b</sup>	<0.350° rms	
45 MHz to 500 MHz	<0.100° rms	
500 MHz to 20 GHz	<0.060° rms	
20 GHz to 40 GHz	<0.100° rms	
40 GHz to 50 GHz	<0.100° rms	
<b>Trace Noise Phase - Option 080 enabled<sup>b,d</sup></b>		
1 kHz IF bandwidth. Ratio measurement, nominal power at test port.		
10 MHz to 45 MHz	<0.350° rms	
45 MHz to 500 MHz <sup>e</sup>	<0.100° rms	
500 MHz to 20 GHz	<0.060° rms	
20 GHz to 40 GHz	<0.100° rms	
40 GHz to 50 GHz	<0.100° rms	
<b>Reference Level Magnitude</b>		
Range	+/-200 dB	
Resolution	0.001 dB	
<b>Reference Level Phase</b>		
Range	+/-500°	
Resolution	0.01°	

<b>Stability Magnitude<sup>d</sup></b>					
Typical ratio measurement, made at the test port.					
10 MHz to 45 MHz					+/-0.05 dB/°C
45 MHz to 20 GHz					+/-0.02 dB/°C
20 GHz to 40 GHz					+/-0.03 dB/°C
40 GHz to 50 GHz					+/-0.04 dB/°C
<b>Stability Phase<sup>d</sup></b>					
Typical ratio measurement, measured at the test port.					
10 MHz to 45 MHz					+/-0.5°/°C
45 MHz to 20 GHz					+/-0.2°/°C
20 GHz to 40 GHz					+/-0.5°/°C
40 GHz to 50 GHz					+/-0.8°/°C
<b>Damage Input Level</b>					
Test Port 1 and 2					+20 dBm or +/-40 VDC, typical
R1, R2 in					+15 dBm or +/-15 VDC, typical
A, B in					+15 dBm or +/-15 VDC, typical
Coupler Thru (Option 014 or UNL/014)					+30 dBm or +/-40 VDC, typical
Coupler Arm (Option 014 or UNL/014)					+30 dBm or +/-7 VDC, typical

<sup>a</sup>Total average (rms) noise power calculated as the mean value of a linear magnitude trace expressed in dBm.

<sup>b</sup>Typical performance.

<sup>c</sup>Noise floor may be degraded by 10 dB at particular frequencies (multiples of 5 MHz) due to spurious receiver residuals.

<sup>d</sup>0 Hz offset

<sup>e</sup>Trace noise magnitude may be degraded to 20 mdB rms at harmonic frequencies of the first IF (8.33 MHz) below 80 MHz.

<sup>f</sup>Stability is defined as a ratio measurement made at the test port.

**Table 36.** Dynamic Accuracy (Specification<sup>a</sup>)

Accuracy of the test port input power reading relative to the reference input power level.

### Magnitude\*

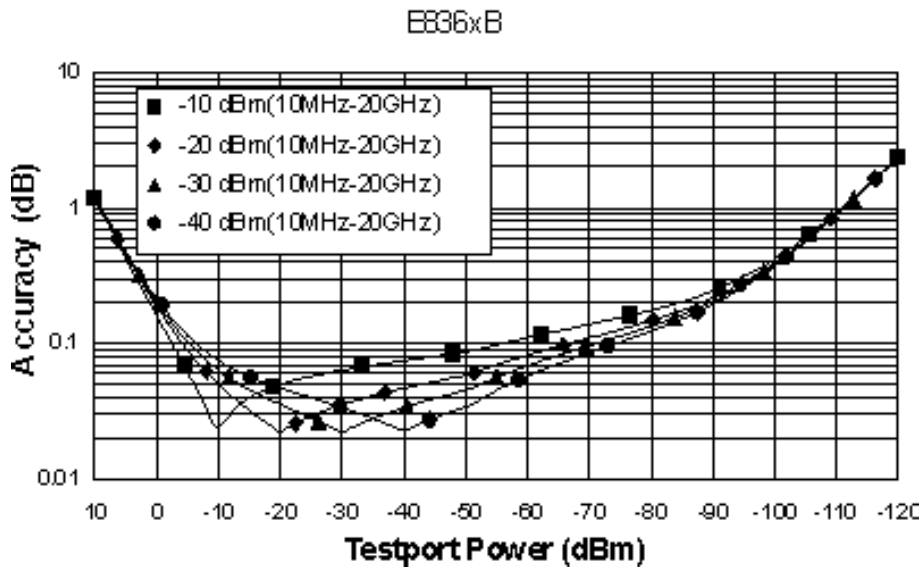

### Phase\*

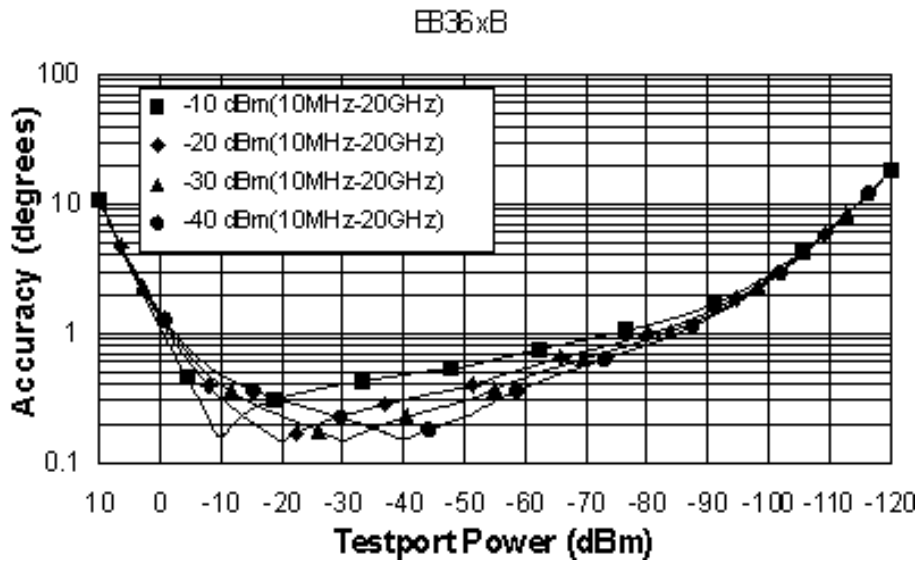

\*Below 800 MHz the coupling factor rolls off 20 dB per decade causing a shift in the dynamic accuracy curves. Please see the Uncertainty Calculator ([http://www.agilent.com/find/na\\_calculator](http://www.agilent.com/find/na_calculator)) for detailed compression values.

### Magnitude

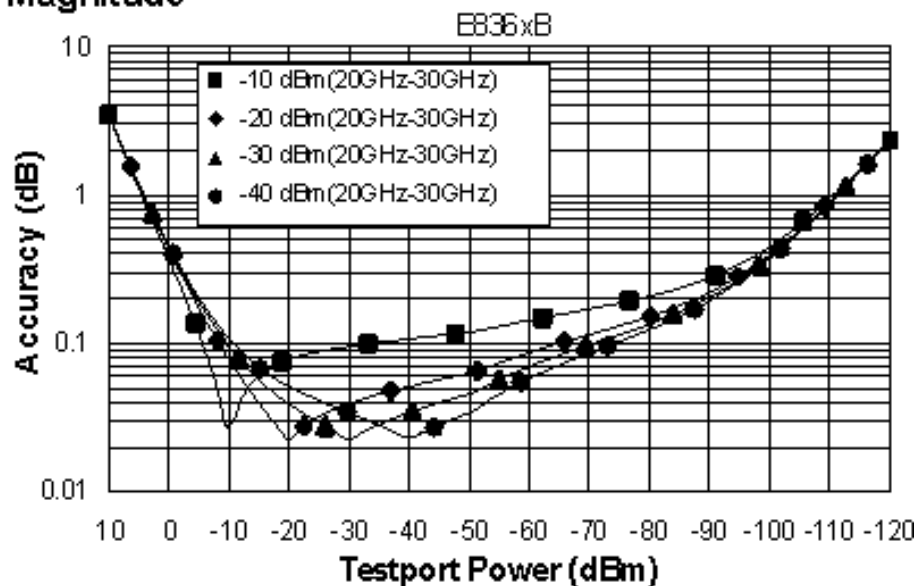

### Phase

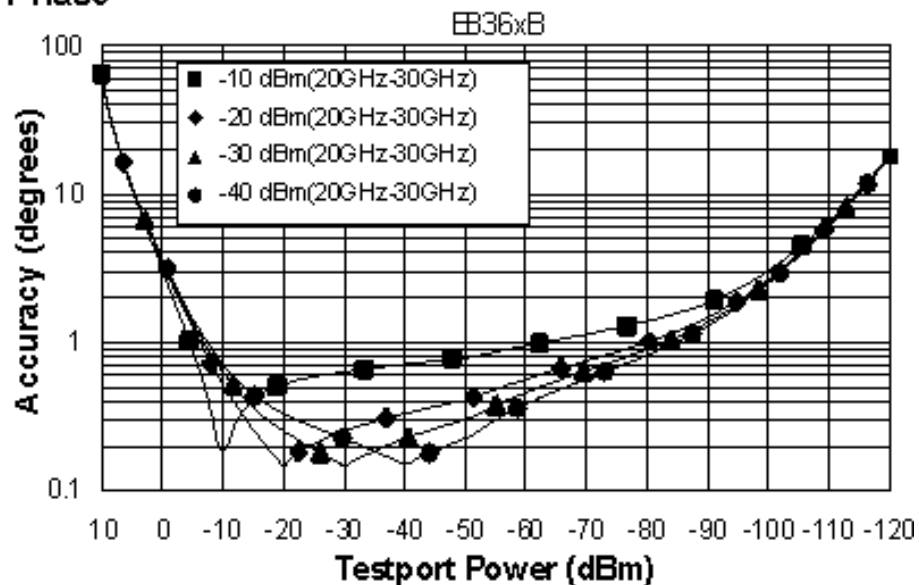

### Magnitude

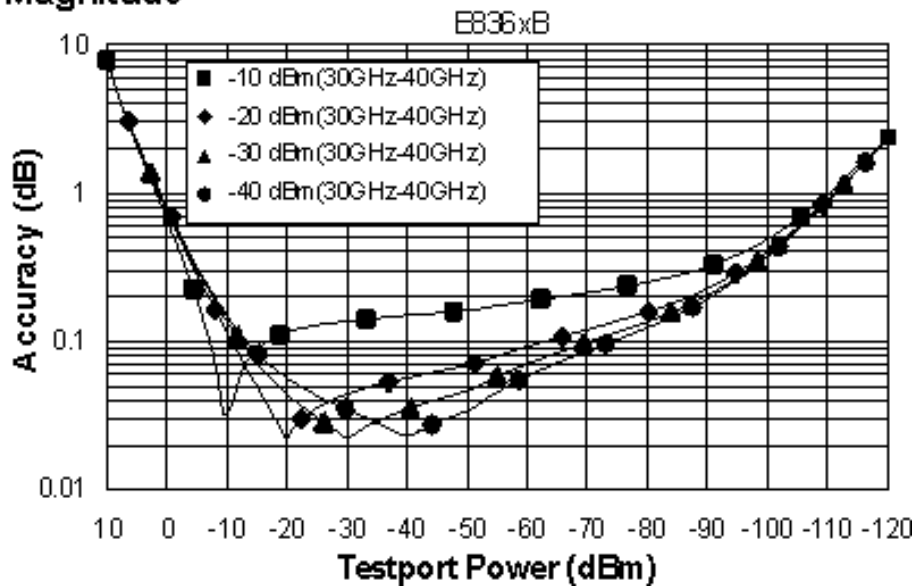

### Phase

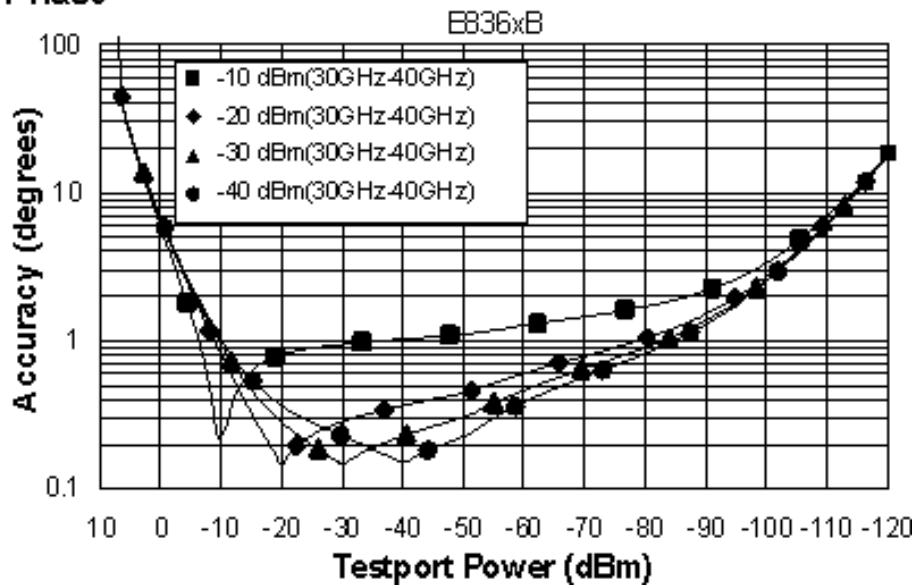

## Magnitude

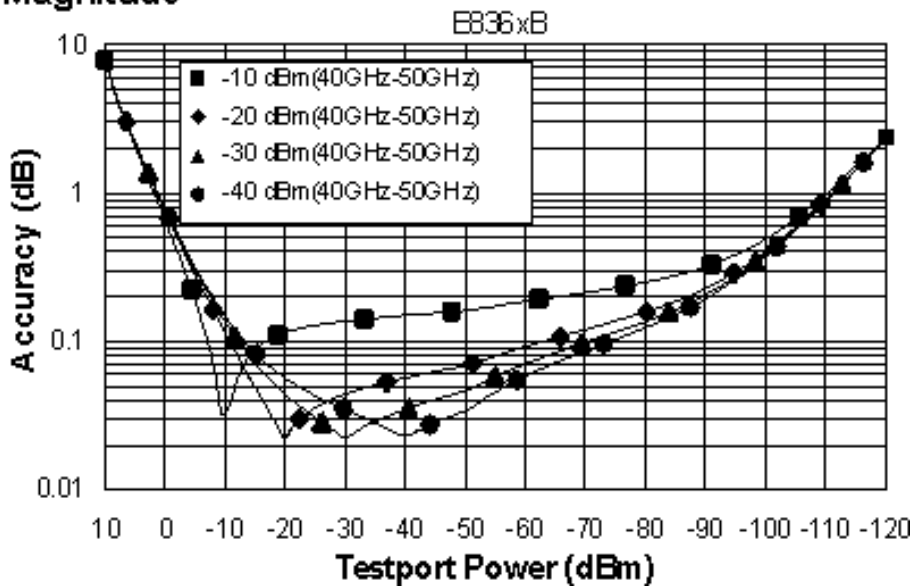

## Phase

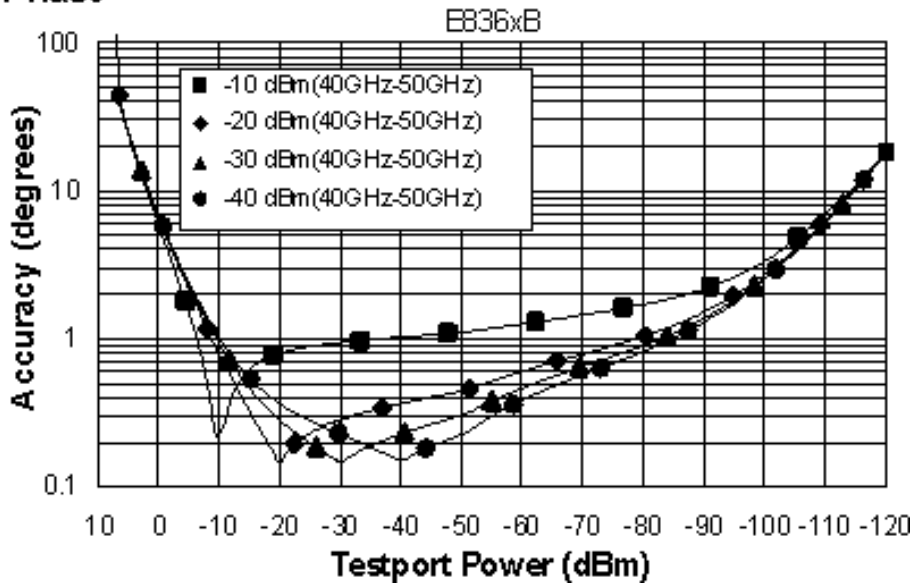

<sup>a</sup> Dynamic accuracy is verified with the following measurements:

- compression over frequency
- IF linearity at a single frequency of 1.195 GHz and a reference level of -20 dBm

**Table 37. Test Port Input (Group Delay)<sup>a</sup>**

Description	Specification	Supplemental Information
Aperture (selectable)	(frequency span)/(number of points - 1)	
Maximum Aperture	20% of frequency span	
Range	0.5 x (1/minimum aperture)	
Maximum Delay		Limited to measuring no more than 180° of phase change within the minimum aperture.)
Accuracy		See graph below. Char.

The following graph shows characteristic group delay accuracy with full 2-port calibration and a 10 Hz IF bandwidth. Insertion loss is assumed to be < 2 dB and electrical length to be ten meters.

**Group Delay (Typical)**

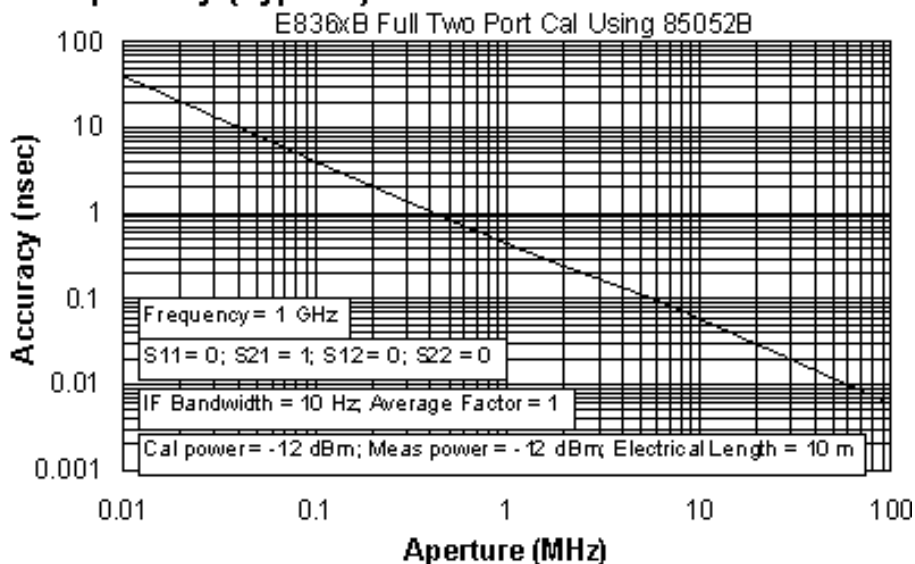

In general, the following formula can be used to determine the accuracy, in seconds, of specific group delay measurement:

$$\pm \text{Phase Accuracy (deg)} / [360 \times \text{Aperture (Hz)}]$$

Depending on the aperture and device length, the phase accuracy used is either incremental phase accuracy or worst case phase accuracy.

<sup>a</sup> Group delay is computed by measuring the phase change within a specified frequency step (determined by the frequency span and the number of points per sweep).

## General Information

Table 38. Miscellaneous Information

Description	Specification	Supplemental Information
System IF Bandwidth Range		1 Hz to 40 kHz, nominal
CPU		Intel® 500 MHz Pentium® III

Table 39. Front Panel Information

Description	Supplemental Information
<b>RF Connectors</b>	
<b>E8362B</b>	
Type	3.5 mm (male), 50 ohm, (nominal)
Center Pin Recession	0.002 in. (characteristic)
<b>E8363/4B</b>	
Type	2.4 mm (male), 50 ohm, (nominal)
Center Pin Recession	0.002 in. (characteristic)
<b>Display</b>	
Size	21.3 cm (8.4 in) diagonal color active matrix LCD; 640 (horizontal) X 480 (vertical) resolution; 59.83 Hz vertical refresh rate; 31.41 Hz horizontal refresh rate
Refresh Rate	Vertical 59.83 Hz; Horizontal 31.41 Hz
<b>Display Range</b>	
Magnitude	±200 dB (at 20 dB/div), max
Phase	±180°, max
Polar	10 pUnits, min 1000 Units, max
<b>Display Resolution</b>	
Magnitude	0.001 dB/div, min
Phase	0.01°/div, min
<b>Marker Resolution</b>	
Magnitude	0.001 dB, min
Phase	0.01°, min
Polar	0.01 mUnit, min; 0.01°,min



**Table 40.** Rear Panel Information

Description	Supplemental Information
<b>10 MHz Reference In</b>	
Connector	BNC, female
Input Frequency	10 MHz $\pm$ 10 ppm, typical
Input Level	-15 dBm to +20 dBm, typical
Input Impedance	200 $\Omega$ , nom.
<b>10 MHz Reference Out</b>	
Connector	BNC, female
Output Frequency	10 MHz $\pm$ 1 ppm, typical
Signal Type	Sine Wave, typical
Output Level	+10 dBm $\pm$ 4 dB into 50 $\Omega$ , typical
Output Impedance	50 $\Omega$ , nominal
Harmonics	<-40 dBc, typical
<b>VGA Video Output</b>	
Connector	15-pin mini D-Sub; Drives VGA compatible monitors
Devices Supported:	
	<b>Resolutions:</b>
Flat Panel (TFT)	1024 X 768, 800 X 600, 640 X 480
Flat Panel (DSTN)	800 X 600, 640 X 480
CRT Monitor	1280 X 1024, 1024 X 768, 800 X 600, 640 X 480
	Simultaneous operation of the internal and external displays is allowed, but with 640 X 480 resolution only. If you change resolution, you can only view the external display (internal display will "white out").
<b>Test Set IO</b>	
	25-pin D-Sub connector, available for external test set control
<b>Aux IO</b>	
	25-pin D-Sub connector, male, analog and digital IO
<b>Handler IO</b>	
	36-pin parallel I/O port; all input/output signals are default set to negative logic; can be reset to positive logic via GPIB command
<b>GPIB</b>	
	24-pin D-sub (Type D-24), female; compatible with IEEE-488.
<b>Parallel Port (LPT1)</b>	
	25-pin D-Sub miniature connector, female; provides connection to printers or any other parallel port peripherals
<b>Serial Port (COM 1)</b>	
	9-pin D-Sub, male; compatible with RS-232
<b>USB Port</b>	
	One port on front panel and five ports on rear panel. Universal Serial Bus jack, Type A configuration (4 contacts inline, contact 1 on left); female
Contact 1	Vcc: 4.75 to 5.25 VDC, 500 mA, maximum
Contact 2	-Data
Contact 3	+Data
Contact 4	Ground
<b>LAN</b>	
	10/100BaseT Ethernet, 8-pin configuration; auto selects between the two data rates

<b>Line Power<sup>a</sup></b>	
Frequency	48 Hz to 66 Hz
Voltage at 115 V Setting	90 to 132 VAC; 120 VAC, nominal
Voltage at 220 V Setting	198 to 264 VAC; 240 VAC, nominal
VA Max	600 VA maximum

<sup>a</sup> A third-wire ground is required.

**Table 41.** Analyzer Environment and Dimensions

<b>Description</b>	<b>Supplemental Information</b>		
<b>General Environmental</b>			
RFI/EMI Susceptibility	Defined by CISPR Pub. 11, Group 1, Class A, and IEC 50082-1		
ESD	Minimize using static-safe work procedures and an antistatic bench mat		
Dust	Minimize for optimum reliability		
<b>Operating Environment</b>			
Temperature	0 °C to +40 °C Instrument powers up, phase locks, and displays no error messages within this temperature range (except for "source unlevelled" error message that may occur at temperature extremes).		
Error-Corrected Temperature Range	23°C ± 3°C with less than 1°C deviation from calibration temp.		
Humidity	5% to 95% at +40 °C		
Altitude	0 to 4500 m (14,760 ft.)		
<b>Non-Operating Storage Environment</b>			
Temperature	-40 °C to +70 °C		
Humidity	0% to 90% at +65 °C (non-condensing)		
Altitude	0 to 15,240 m (50,000 ft.)		
<b>Cabinet Dimensions</b>			
	<b>Height</b>	<b>Width</b>	<b>Depth</b>
Excluding front and rear panel hardware and feet	267 mm 10.5 in	425 mm 16.75 in	426 mm 16.8 in
As shipped - includes front panel connectors, rear panel bumpers, and feet.	305 mm 12.0 in	425 mm 16.75 in	470 mm 18.5 in
As shipped plus handles	305 mm 12.0 in	458 mm 18 in	502 mm 19.75 in
As shipped plus rack-mount flanges	305 mm 12.0 in	483 mm 19 in	470 mm 18.5 in
As shipped plus handles and flanges	305 mm 12.0 in	483 mm 19 in	502 mm 19.75 in
<b>Weight</b>			
<b>Net</b>			
E8362B	28.6 kg (63.5 lb), nominal		
E8363/4B	29 kg (64 lb), nominal		
<b>Shipping</b>			
E8362B	35.8 kg (79.5 lb), nominal		
E8363/4B	36.3 kg 80 lb), nominal		

## Measurement Throughput Summary

Table 42 Typical Cycle Time<sup>a,b</sup> (ms) for Measurement Completion

	Number of Points			
	201	401	1601	16,001
<b>Start 28 GHz, Stop 30 GHz, 35 kHz IF bandwidth</b>				
Uncorrected, 1-port cal	12	19	55	503
2-Port cal	29	44	124	1112
<b>Start 10 MHz, Stop 10 GHz, 35 kHz IF bandwidth</b>				
Uncorrected, 1-port cal	86	93	121	583
2-Port cal	179	199	267	1301
<b>Start 10 MHz, Stop 20 GHz, 35 kHz IF bandwidth</b>				
Uncorrected, 1-port cal	126	130	153	597
2-Port cal	264	275	335	1321
<b>Start 10 MHz, Stop 40 GHz, 35 kHz IF bandwidth</b>				
Uncorrected, 1-port cal	185	190	213	621
2-Port cal	382	401	459	1374
<b>Start 10 MHz, Stop 50 GHz, 35 kHz IF bandwidth</b>				
Uncorrected, 1-port cal	210	216	243	643
2-Port cal	436	450	522	1405
<b>Start 10 MHz, Stop 67 GHz, 35 kHz IF bandwidth</b>				
Uncorrected	244	254	300	645
Corrected	502	524	591	1423

<sup>a</sup> Typical performance.

<sup>b</sup> Includes sweep time, retrace time and band-crossing time. Analyzer display turned off with DISPLAY:ENABLE OFF. Add 21 ms for display on. Data for one trace (S11) measurement.

**Table 43.** Cycle Time vs IF Bandwidth<sup>a</sup>

Applies to the Preset condition (201 points, correction off) except for the following changes:

- CF = 28 GHz
- Span = 100 MHz
- Display off (add 21 ms for display on)

IF Bandwidth (Hz)	Cycle Time (ms) <sup>b</sup>	Cycle Time (ms) Option 080 enabled
40,000	11	100
35,000	12	101
30,000	13	102
20,000	16	106
10,000	30	127
7000	38	138
5000	50	152
3000	74	182
1000	274	326
300	694	782
100	1905	2054
30	6091	6355
10	17916	18372

<sup>a</sup> Typical performance.

<sup>b</sup> Cycle time includes sweep and retrace time.

**Table 44.** Cycle Time vs Number of Points<sup>a</sup>

Applies to the Preset condition (35 kHz IF bandwidth, correction off) except for the following changes:

- CF = 28 GHz
- Span = 100 MHz
- Display off (add 21 ms for display on)

Number of Points	Cycle Time (ms) <sup>b</sup>
3	6
11	6
51	7
101	9
201	12
401	18
801	30
1601	55
16,001	497

<sup>a</sup> Typical performance.

<sup>b</sup> Cycle time includes sweep and retrace time.

**Table 45.** Data Transfer Time (ms)<sup>a</sup>

	<b>Number of Points</b>			
	201	401	1601	16,001
<b>SCPI over GPIB</b>				
<b>(program executed on external PC)</b>				
32-bit floating point	7	12	43	435
64-bit floating point	12	22	84	856
ASCII	64	124	489	5054
<b>SCPI</b>				
<b>(program executed in the analyzer)</b>				
32-bit floating point	1	2	3	30
64-bit floating point	2	2	4	40
ASCII	29	56	222	2220
<b>COM (program executed in the analyzer)</b>				
32-bit floating point	1	1	1	6
Variant type	1	2	6	68
<b>DCOM over LAN</b>				
<b>(program executed on external PC)</b>				
32-bit floating point	1	1	2	121
Variant type	3	6	19	939

<sup>a</sup>Typical performance

---

**Note:** Specifications for Recall & Sweep Speed are not provided for the E836xB analyzers.

---

## Specifications: Front-Panel Jumpers

### Models E8362B, E8363B, and E8364B Option 014

**NOTE:** The standard E8362/3/4B has no front-panel jumpers.

**Table 46: Measurement Receiver Inputs (Rcvr A In, Rcvr B In)**

Description	Specification	Supplemental Information
<b>Maximum Input Level</b>		
<b>E8362B:</b>		
45 MHz to 500 MHz		-15 dBm, typical
500 MHz to 2 GHz		-11 dBm, typical
2 GHz to 10 GHz		-11 dBm, typical
10 GHz to 20 GHz		-11 dBm, typical
<b>E8363B:</b>		
45 MHz to 500 MHz		-14 dBm, typical
500 MHz to 2 GHz		-10 dBm, typical
2 GHz to 10 GHz		-10 dBm, typical
10 GHz to 20 GHz		-10 dBm, typical
20 GHz to 30 GHz		-14.5 dBm, typical
30 GHz to 40 GHz		-16.5 dBm, typical
<b>E8364B:</b>		
45 MHz to 500 MHz		- 14 dBm, typical
500 MHz to 2 GHz		- 10 dBm, typical
2 GHz to 10 GHz		- 10 dBm, typical
10 GHz to 20 GHz		- 10 dBm, typical
20 GHz to 30 GHz		- 14.5 dBm, typical
30 GHz to 40 GHz		- 16.5 dBm, typical
40 GHz to 45 GHz		- 16 dBm, typical
45 GHz to 50 GHz		- 15 dBm, typical
<b>Noise Floor</b>		
<b>E8362B:</b>		
	<b>10 Hz IF Bandwidth</b>	
45 MHz to 500 MHz	< -109 dBm	
500 MHz to 2 GHz	< -130 dBm	
2 GHz to 10 GHz	< -133 dBm	
10 GHz to 20 GHz	< -135 dBm	
	<b>1 kHz IF Bandwidth</b>	
45 MHz to 500 MHz	< -89 dBm	
500 MHz to 2 GHz	< -110 dBm	
2 GHz to 10 GHz	< -113 dBm	
10 GHz to 20 GHz	< -115 dBm	

<b>E8363B:</b>		
	<b>10 Hz IF Bandwidth</b>	
45 MHz to 500 MHz	< -127 dBm	
500 MHz to 2 GHz	< -133 dBm	
2 GHz to 10 GHz	< -132 dBm	
10 GHz to 20 GHz	< -134 dBm	
20 GHz to 40 GHz	< -125 dBm	
	<b>1 kHz IF Bandwidth</b>	
45 MHz to 500 MHz	< -107 dBm	
500 MHz to 2 GHz	< -113 dBm	
2 GHz to 10 GHz	< -112 dBm	
10 GHz to 20 GHz	< -114 dBm	
20 GHz to 40 GHz	< -105 dBm	
<b>E8364B:</b>		
	<b>10 Hz IF Bandwidth</b>	
45 MHz to 500 MHz	< - 127 dBm	
500 MHz to 2 GHz	< - 133 dBm	
2 GHz to 10 GHz	< - 132 dBm	
10 GHz to 20 GHz	< - 134 dBm	
20 GHz to 40 GHz	< - 125 dBm	
40 GHz to 50 GHz	< - 123 dBm	
	<b>1 kHz IF Bandwidth</b>	
45 MHz to 500 MHz	< -107 dBm	
500 MHz to 2 GHz	< -113 dBm	
2 GHz to 10 GHz	< -112 dBm	
10 GHz to 20 GHz	< -114 dBm	
20 GHz to 40 GHz	< -105 dBm	
40 GHz to 50 GHz	< -103 dBm	
<b>Damage Level</b>		
E8362B		+ 15 dBm, typical
E8363B		+ 15 dBm, typical
E8364B		+ 15 dBm, typical
<b>Maximum DC Level</b>		
E8362B		+ 15 V, typical
E8363B		+ 15 V, typical
E8364B		+ 15 V, typical

**Table 47: Reference Receiver Inputs (Rcvr R1, Rcvr R2)**

<b>Description</b>	<b>Specification</b>	<b>Supplemental Information</b>
<b>Maximum Input Level</b>		
<b>E8362B:</b>		
45 MHz to 500 MHz		-15 dBm, typical
500 MHz to 2 GHz		-11 dBm, typical
2 GHz to 10 GHz		-11 dBm, typical
10 GHz to 20 GHz		-11 dBm, typical
<b>E8363B:</b>		
45 MHz to 500 MHz		-14 dBm, typical
500 MHz to 2 GHz		-10 dBm, typical
2 GHz to 10 GHz		-10 dBm, typical
10 GHz to 20 GHz		-9.5 dBm, typical
20 GHz to 30 GHz		-14 dBm, typical
30 GHz to 40 GHz		-15.5 dBm, typical
<b>E8364B:</b>		
45 MHz to 500 MHz		- 14 dBm, typical
500 MHz to 2 GHz		- 10 dBm, typical
2 GHz to 10 GHz		- 10 dBm, typical
10 GHz to 20 GHz		- 9.5 dBm, typical
20 GHz to 30 GHz		- 14 dBm, typical
30 GHz to 40 GHz		- 15.5 dBm, typical
40 GHz to 45 GHz		- 14 dBm, typical
45 GHz to 50 GHz		- 15 dBm, typical
<b>Damage Level</b>		
E8362B		+ 15 dBm, typical
E8363B		+ 15 dBm, typical
E8364B		+ 15 dBm, typical
<b>Maximum DC Level</b>		
E8362B		+/- 15 V, typical
E8363B		+/- 15 V, typical
E8364B		+/- 15 V, typical



**Table 48: Reference Outputs (Reference 1 Source Out, Reference 2 Source Out)**

<b>Description</b>	<b>Specification</b>	<b>Supplemental Information</b>
<b>Maximum Output Level</b>		
<b>E8362B:</b>		
45 MHz to 500 MHz		-24 dBm, typical
500 MHz to 2 GHz		-23 dBm, typical
2 GHz to 10 GHz		-23 dBm, typical
10 GHz to 20 GHz		-26 dBm, typical
<b>E8363B:</b>		
45 MHz to 500 MHz		-11.5 dBm, typical
500 MHz to 2 GHz		-10.5 dBm, typical
2 GHz to 10 GHz		-11 dBm, typical
10 GHz to 20 GHz		-11 dBm, typical
20 GHz to 30 GHz		-11 dBm, typical
30 GHz to 40 GHz		-11 dBm, typical
<b>E8364B:</b>		
45 MHz to 500 MHz		- 11.5 dBm, typical
500 MHz to 2 GHz		- 10.5 dBm, typical
2 GHz to 10 GHz		- 11 dBm, typical
10 GHz to 20 GHz		- 11 dBm, typical
20 GHz to 30 GHz		- 11 dBm, typical
30 GHz to 40 GHz		- 11 dBm, typical
40 GHz to 45 GHz		- 11 dBm, typical
45 GHz to 50 GHz		- 15 dBm, typical
<b>Damage Level</b>		
E8362B		+ 20 dBm, typical
E8363B		+ 20 dBm, typical
E8364B		+ 20 dBm, typical
<b>Maximum DC Level</b>		
E8362B		+/- 15 V, typical
E8363B		+/- 15 V, typical
E8364B		+/- 15 V, typical

Table 49: Source Outputs (Port 1 Source Out, Port 2 Source Out)

Description	Specification	Supplemental Information
<b>Maximum Output Level</b>		
<b>E8362B, Option 014:</b>		
45 MHz to 500 MHz		6 dBm, typical
500 MHz to 2 GHz		7 dBm, typical
2 GHz to 10 GHz		7 dBm, typical
10 GHz to 20 GHz		4 dBm, typical
<b>E8362B, Option 014 and UNL:</b>		
45 MHz to 500 MHz		4 dBm, typical
500 MHz to 2 GHz		5 dBm, typical
2 GHz to 10 GHz		5 dBm, typical
10 GHz to 20 GHz		2 dBm, typical
<b>E8363B, Option 014:</b>		
45 MHz to 500 MHz		5.5 dBm, typical
500 MHz to 2 GHz		6.5 dBm, typical
2 GHz to 10 GHz		6.5 dBm, typical
10 GHz to 20 GHz		4 dBm, typical
20 GHz to 30 GHz		1- dBm, typical
30 GHz to 40 GHz		-2 dBm, typical
<b>E8363B, Option 014 and UNL:</b>		
45 MHz to 500 MHz		3.5 dBm, typical
500 MHz to 2 GHz		5 dBm, typical
2 GHz to 10 GHz		5 dBm, typical
10 GHz to 20 GHz		3.5- dBm, typical
20 GHz to 30 GHz		0 dBm, typical
30 GHz to 40 GHz		-2.5 dBm, typical
<b>E8364B, Option 014:</b>		
45 MHz to 500 MHz		5.5 dBm, typical
500 MHz to 2 GHz		6.5 dBm, typical
2 GHz to 10 GHz		6.5 dBm, typical
10 GHz to 20 GHz		4 dBm, typical
20 GHz to 30 GHz		1 dBm, typical
30 GHz to 40 GHz		-2 dBm, typical
40 GHz to 45 GHz		-3 dBm, typical
45 GHz to 50 GHz		-7.5 dBm, typical
<b>E8364B, Option 014 and UNL:</b>		
45 MHz to 500 MHz		3.5 dBm, typical
500 MHz to 2 GHz		5 dBm, typical
2 GHz to 10 GHz		5 dBm, typical
10 GHz to 20 GHz		3.5 dBm, typical
20 GHz to 30 GHz		0 dBm, typical
30 GHz to 40 GHz		-2.5 dBm, typical
40 GHz to 45 GHz		-5 dBm, typical
45 GHz to 50 GHz		-10 dBm, typical
<b>Damage Level</b>		
E8362B		20 dBm, typical
E8363B		20 dBm, typical
E8364B		20 dBm, typical

Maximum DC Level		
E8362B		0 V, typical
E8363B		0 V, typical
E8364B		0 V, typical

Table 50: Coupler Inputs (Port 1 Cplr Thru, Port 2 Cplr Thru)

Description	Specification	Supplemental Information
<b>Insertion Loss to Test Port</b>		
<b>E8362B, Option 014:</b>		
45 MHz to 500 MHz		0.5 dB, typical
500 MHz to 2 GHz		1.5 dB, typical
2 GHz to 10 GHz		1.5 dB, typical
10 GHz to 20 GHz		1.5 dB, typical
<b>E8362B, Option 014 and UNL:</b>		
45 MHz to 500 MHz		1 dB, typical
500 MHz to 2 GHz		2 dB, typical
2 GHz to 10 GHz		2 dB, typical
10 GHz to 20 GHz		2 dB, typical
<b>E8363B, Option 014:</b>		
45 MHz to 500 MHz		0.5 dB, typical
500 MHz to 2 GHz		0.5 dB, typical
2 GHz to 10 GHz		1.5 dB, typical
10 GHz to 20 GHz		2 dB, typical
20 GHz to 30 GHz		3 dB, typical
30 GHz to 40 GHz		3.5 dB, typical
<b>E8363B, Option 014 and UNL:</b>		
45 MHz to 500 MHz		0.5 dB, typical
500 MHz to 2 GHz		1 dB, typical
2 GHz to 10 GHz		2 dB, typical
10 GHz to 20 GHz		3 dB, typical
20 GHz to 30 GHz		4 dB, typical
30 GHz to 40 GHz		5 dB, typical
<b>E8364B, Option 014:</b>		
45 MHz to 500 MHz		0.5 dB, typical
500 MHz to 2 GHz		0.5 dB, typical
2 GHz to 10 GHz		1.5 dB, typical
10 GHz to 20 GHz		2 dB, typical
20 GHz to 30 GHz		3 dB, typical
30 GHz to 40 GHz		3.5 dB, typical
40 GHz to 45 GHz		3.5 dB, typical
45 GHz to 50 GHz		4 dB, typical

<b>E8364B, Option 014 and UNL:</b>		
45 MHz to 500 MHz		0.5 dB, typical
500 MHz to 2 GHz		1 dB, typical
2 GHz to 10 GHz		2 dB, typical
10 GHz to 20 GHz		3 dB, typical
20 GHz to 30 GHz		4 dB, typical
30 GHz to 40 GHz		5 dB, typical
40 GHz to 45 GHz		5.5 dB, typical
45 GHz to 50 GHz		6 dB, typical
<b>Damage Level</b>		
E8362B		+ 30 dBm, typical
E8363B		+ 30 dBm, typical
E8364B		+ 30 dBm, typical
<b>Maximum DC Level</b>		
E8362B		+/- 40 V, typical
E8363B		+/- 40 V, typical
E8364B		+/- 40 V, typical

Table 51: Coupler Outputs (Port 1 Cplr Arm, Port 2 Cplr Arm)

Description	Specification	Supplemental Information
<b>Damage Level</b>		
E8362B		+ 30 dBm, typical
E8363B		+ 30 dBm, typical
E8364B		+ 30 dBm, typical
<b>Maximum DC Level</b>		
E8362B		+/- 7 V, typical
E8363B		+/- 7 V, typical
E8364B		+/- 7 V, typical

Test Set Block Diagrams

E836xB - Standard Configuration and Standard Power Range

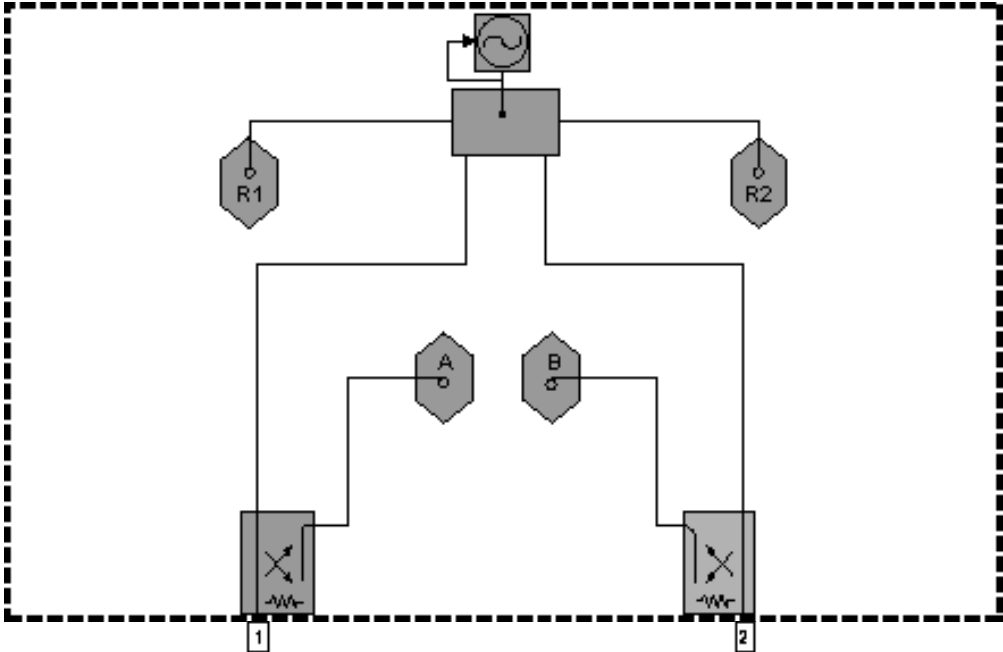

E836xB - Option UNL Standard Configuration with Extended Power Range and Bias - Tees

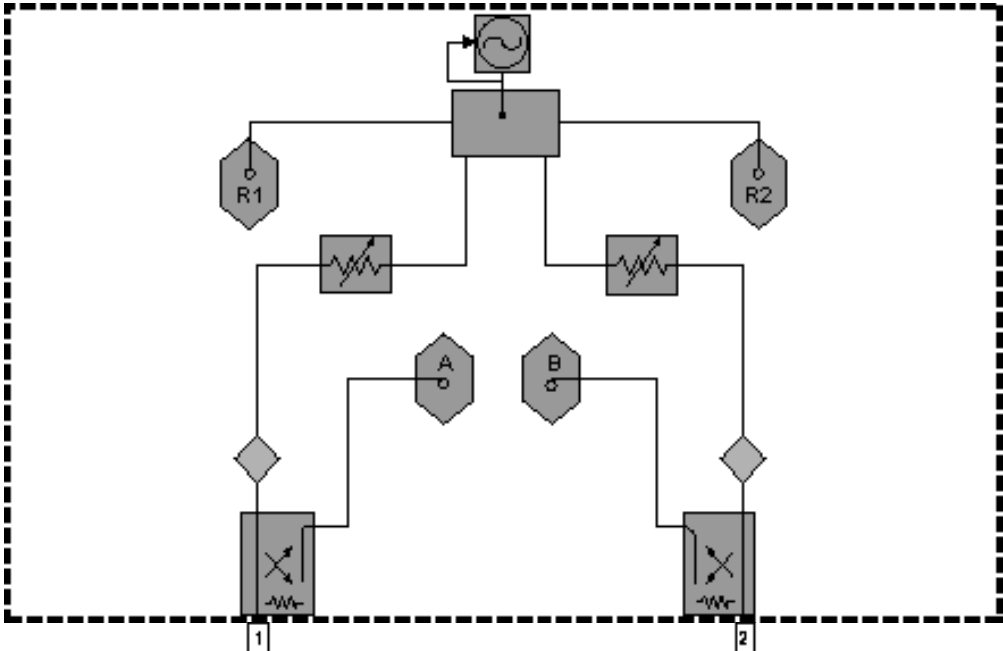

**E836xB - Option UNL** Standard Configuration with Extended Power Range and Bias - Tees, and **Option 016**, Receiver Attenuators

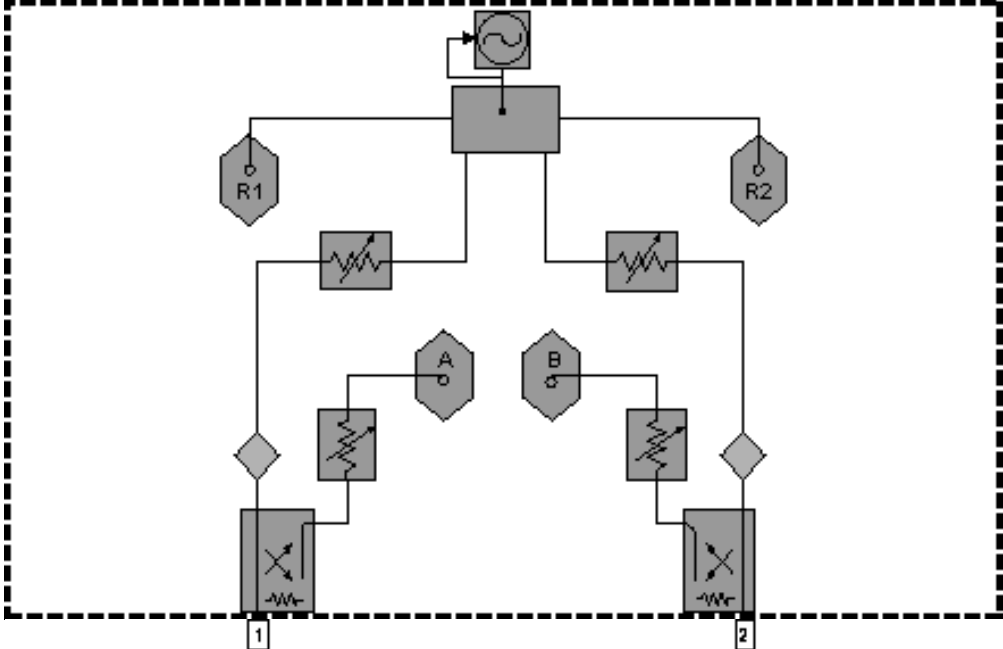

## Test Set with Option 014 Block Diagrams

E836xB - Option 014 Configurable Test Set and Standard Power Range

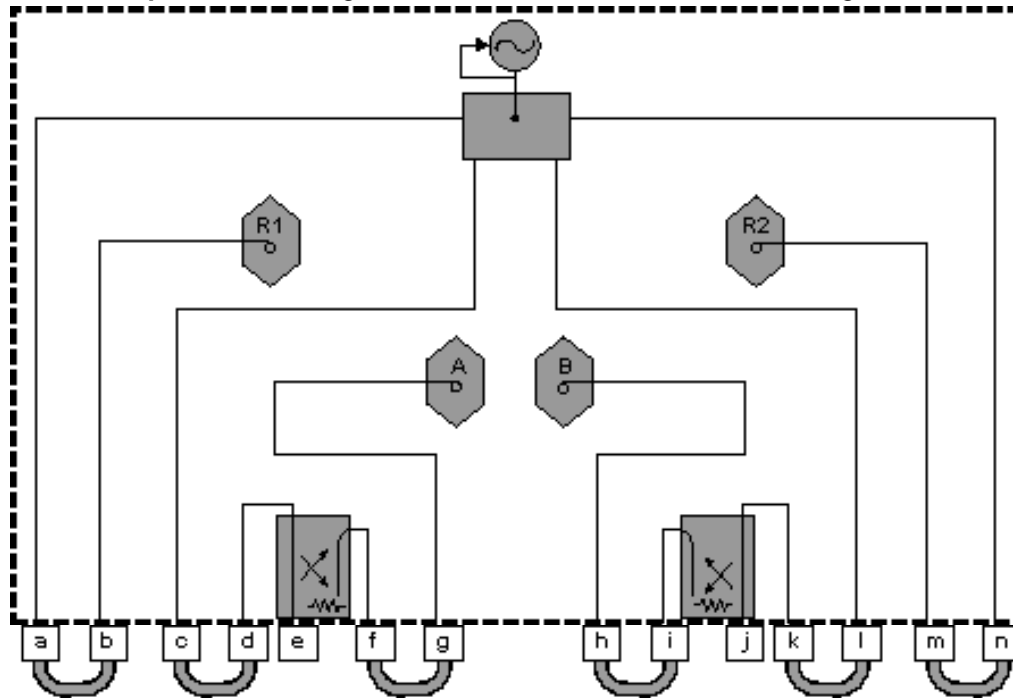

Item	Description	Item	Description
a	SOURCE OUT	h	RCVR B IN
b	RCVR R1 IN	i	CPLR ARM
c	SOURCE OUT	j	PORT 2
d	CPLR THRU	k	CPLR THRU
e	PORT 1	l	SOURCE OUT
f	CPLR ARM	m	RCVR R2 IN
g	RCVR A IN	n	SOURCE OUT

**E836xB - Option 014** Configurable Test Set and Standard Power Range, and **Option 081** Reference Channel Transfer Switch

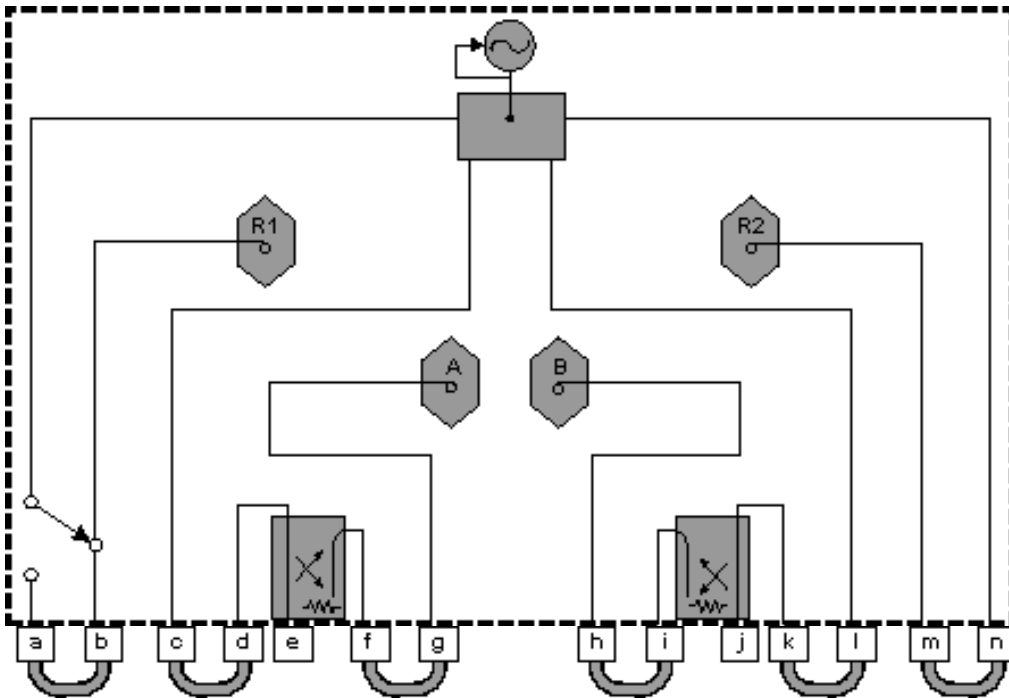

Item	Description	Item	Description
a	SOURCE OUT	h	RCVR B IN
b	RCVR R1 IN	i	CPLR ARM
c	SOURCE OUT	j	PORT 2
d	CPLR THRU	k	CPLR THRU
e	PORT 1	l	SOURCE OUT
f	CPLR ARM	m	RCVR R2 IN
g	RCVR A IN	n	SOURCE OUT



**E836xB - Option 014** Configurable Test Set, and **Option UNL** Extended Power Range and Bias - Tees

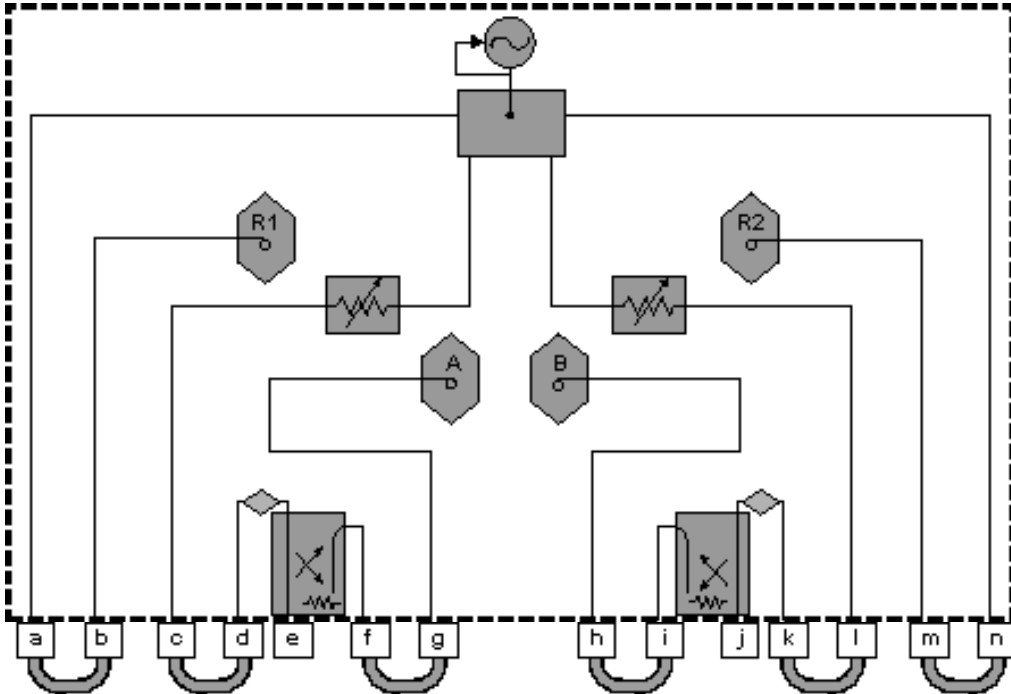

Item	Description	Item	Description
a	SOURCE OUT	h	RCVR B IN
b	RCVR R1 IN	i	CPLR ARM
c	SOURCE OUT	j	PORT 2
d	CPLR THRU	k	CPLR THRU
e	PORT 1	l	SOURCE OUT
f	CPLR ARM	m	RCVR R2 IN
g	RCVR A IN	n	SOURCE OUT

**E836xB - Option 014** Configurable Test Set, and **Option UNL** Extended Power Range and Bias - Tees, and **Option 081** Reference Channel Transfer Switch

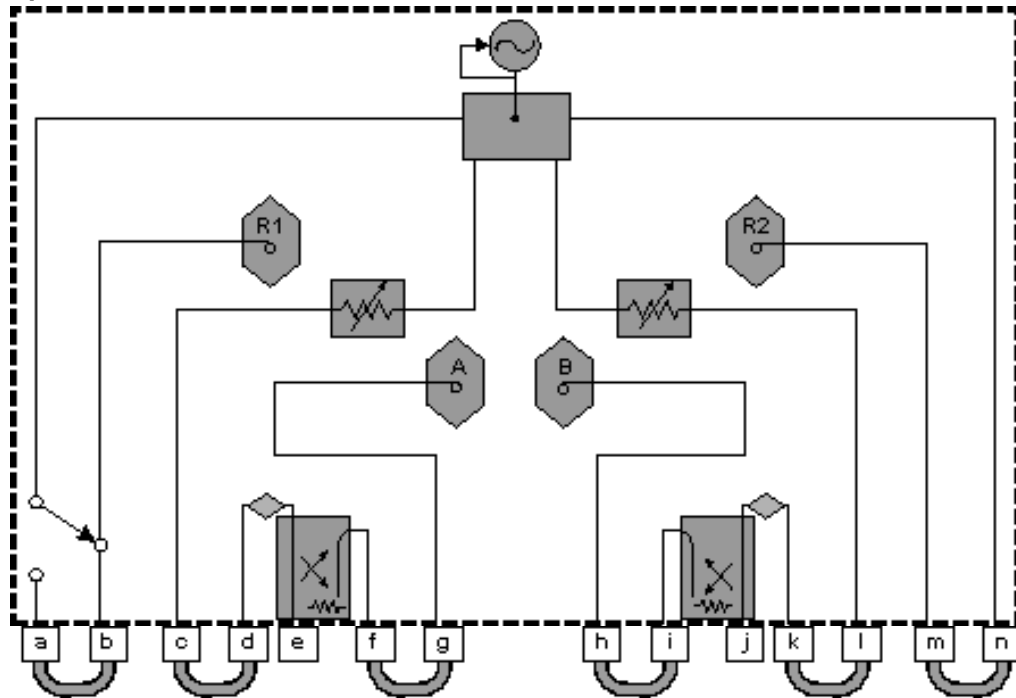

Item	Description	Item	Description
a	SOURCE OUT	h	RCVR B IN
b	RCVR R1 IN	i	CPLR ARM
c	SOURCE OUT	j	PORT 2
d	CPLR THRU	k	CPLR THRU
e	PORT 1	l	SOURCE OUT
f	CPLR ARM	m	RCVR R2 IN
g	RCVR A IN	n	SOURCE OUT

**E836xB - Option 014** Configurable Test Set and **Option UNL**, Extended Power Range and Bias - Tees and **Option 016** Receiver Attenuators

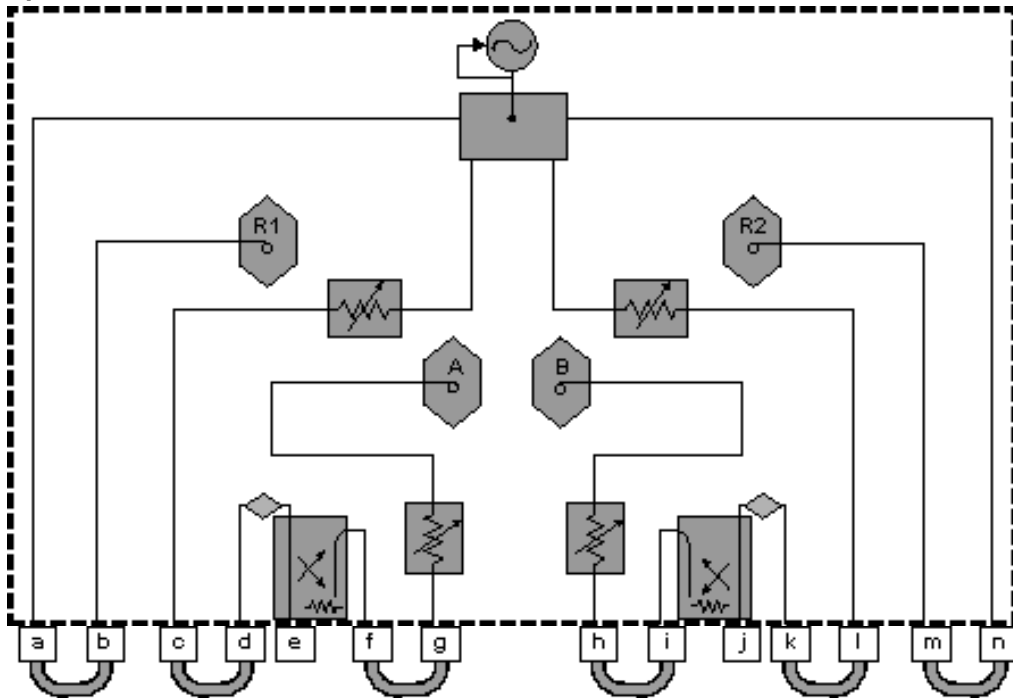

Item	Description	Item	Description
a	SOURCE OUT	h	RCVR B IN
b	RCVR R1 IN	i	CPLR ARM
c	SOURCE OUT	j	PORT 2
d	CPLR THRU	k	CPLR THRU
e	PORT 1	l	SOURCE OUT
f	CPLR ARM	m	RCVR R2 IN
g	RCVR A IN	n	SOURCE OUT

**E836xB - Option 014** Configurable Test Set, and **Option UNL** Extended Power Range and Bias - Tees, and **Option 016** Receiver Attenuators, and **Option 081** Reference Channel Transfer Switch

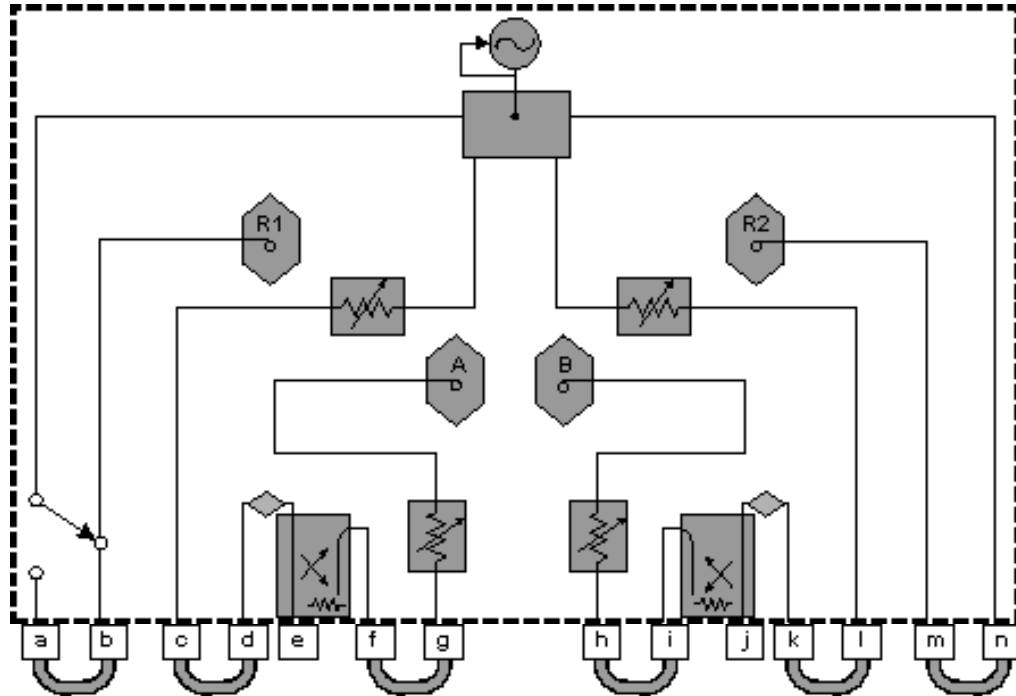

Item	Description	Item	Description
a	SOURCE OUT	h	RCVR B IN
b	RCVR R1 IN	i	CPLR ARM
c	SOURCE OUT	j	PORT 2
d	CPLR THRU	k	CPLR THRU
e	PORT 1	l	SOURCE OUT
f	CPLR ARM	m	RCVR R2 IN
g	RCVR A IN	n	SOURCE OUT

## 6 Technical Specifications for the E8361A

<a href="#"><u>Definitions</u></a> .....	6-3
<a href="#"><u>Corrected System Performance</u></a> .....	6-4
<a href="#"><u>Table 1. System Dynamic Range</u></a> .....	6-4
<a href="#"><u>E8361A Corrected System Performance with 1.85mm Connectors</u></a> .....	6-5
<a href="#"><u>E8361A Corrected System Performance with 2.4mm Connectors</u></a> .....	6-5
<a href="#"><u>Table 2. 85056A Calibration Kit E8361A - Standard Configuration and Standard Power Range</u></a> .....	6-5
<a href="#"><u>Table 3. 85056A Calibration Kit E8361A - Fully Optioned (Option 014, and 080)</u></a> .....	6-8
<a href="#"><u>Table 4. 85056D Calibration Kit E8361A - Standard Configuration and Standard Power Range</u></a> .....	6-11
<a href="#"><u>Table 5. 85056D Calibration Kit E8361A - Fully Optioned (Option 014, and 080)</u></a> .....	6-14
<a href="#"><u>E8361A Corrected System Performance with 2.92mm Connectors</u></a> .....	6-17
<a href="#"><u>Table 6. 85056K Calibration Kit E8361A - Standard Configuration and Standard Power Range</u></a> .....	6-17
<a href="#"><u>Table 7. 85056K Calibration Kit E8361A - Fully Optioned (Option 014, and 080)</u></a> .....	6-20
<a href="#"><u>E8361A Corrected System Performance with 3.5mm Connectors</u></a> .....	6-23
<a href="#"><u>Table 8. 85052B Calibration Kit E8361A - Standard Configuration and Standard Power Range</u></a> .....	6-23
<a href="#"><u>Table 9. 85052B Calibration Kit E8361A - Fully Optioned (Option 014, and 080)</u></a> .....	6-26
<a href="#"><u>Table 10. 85052C Calibration Kit E8361A - Standard Configuration and Standard Power Range</u></a> .....	6-29
<a href="#"><u>Table 11. 85052C Calibration Kit E8361A - Fully Optioned (Option 014, and 080)</u></a> .....	6-32
<a href="#"><u>Table 12. 85052D Calibration Kit E8361A - Standard Configuration and Standard Power Range</u></a> .....	6-35
<a href="#"><u>Table 13. 85052D Calibration Kit E8361A - Fully Optioned (Option 014, and 080)</u></a> .....	6-38
<a href="#"><u>E8361A Corrected System Performance with 7mm Connectors</u></a> .....	6-41
<a href="#"><u>Table 14. 85050B Calibration Kit E8361A - Standard Configuration and Standard Power Range</u></a> .....	6-41
<a href="#"><u>Table 15. 85050B Calibration Kit E8361A - Fully Optioned (Option 014, and 080)</u></a> .....	6-44
<a href="#"><u>Table 16. 85050C Calibration Kit E8361A - Standard Configuration and Standard Power Range</u></a> .....	6-47
<a href="#"><u>Table 17. 85050C Calibration Kit E8361A - Fully Optioned (Option 014, and 080)</u></a> .....	6-50
<a href="#"><u>Table 18. 85050D Calibration Kit E8361A - Standard Configuration and Standard Power Range</u></a> .....	6-53
<a href="#"><u>Table 19. 85050D Calibration Kit E8361A - Fully Optioned (Option 014, and 080)</u></a> .....	6-56
<a href="#"><u>E8361A Corrected System Performance with Type-N Connectors</u></a> .....	6-59
<a href="#"><u>Table 20. 85054B Calibration Kit E8361A - Standard Configuration and Standard Power Range</u></a> .....	6-59
<a href="#"><u>Table 21. 85054B Calibration Kit E8361A - Fully Optioned (Option 014, and 080)</u></a> .....	6-62
<a href="#"><u>Table 22. 85054D Calibration Kit E8361A - Standard Configuration and Standard Power Range</u></a> .....	6-65
<a href="#"><u>Table 23. 85054D Calibration Kit E8361A - Fully Optioned (Option 014, and 080)</u></a> .....	6-68
<a href="#"><u>E8361A Corrected System Performance with WR-28 Connectors</u></a> .....	6-71
<a href="#"><u>Table 24. R11644A Calibration Kit E8361A - Standard Configuration and Standard Power Range</u></a> .....	6-71
<a href="#"><u>Table 25. R11644A Calibration Kit E8361A - Fully Optioned (Option 014, and 080)</u></a> .....	6-74
<a href="#"><u>E8361A Corrected System Performance with WR-42 Connectors</u></a> .....	6-77
<a href="#"><u>Table 26. K11644A Calibration Kit E8361A - Standard Configuration and Standard Power Range</u></a> .....	6-77
<a href="#"><u>Table 27. K11644A Calibration Kit E8361A - Fully Optioned (Option 014, and 080)</u></a> .....	6-80
<a href="#"><u>E8361A Corrected System Performance with WR-62 Connectors</u></a> .....	6-83
<a href="#"><u>Table 28. P11644A Calibration Kit E8361A - Standard Configuration and Standard Power Range</u></a> .....	6-83
<a href="#"><u>Table 29. P11644A Calibration Kit E8361A - Fully Optioned (Option 014, and 080)</u></a> .....	6-86
<a href="#"><u>E8361A Corrected System Performance with WR-90 Connectors</u></a> .....	6-89
<a href="#"><u>Table 30. X11644A Calibration Kit E8361A - Standard Configuration and Standard Power Range</u></a> .....	6-89
<a href="#"><u>Table 31. X11644A Calibration Kit E8361A - Fully Optioned (Option 014, and 080)</u></a> .....	6-92
<a href="#"><u>Table 32. Uncorrected System Performance</u></a> .....	6-95
<a href="#"><u>Table 33. Test Port Output</u></a> .....	6-97
<a href="#"><u>Table 34: Test Port Input</u></a> .....	6-102
<a href="#"><u>Table 35. Dynamic Accuracy (Specification)</u></a> .....	6-108

<b><u>Table 36. Test Port Input (Group Delay)</u></b> .....	6-114
<b><u>General Information</u></b> .....	6-114
<b><u>Table 37. Miscellaneous Information</u></b> .....	6-114
<b><u>Table 38. Front Panel Information</u></b> .....	6-114
<b><u>Table 39. Rear Panel Information</u></b> .....	6-115
<b><u>Table 40. Analyzer Environment and Dimensions</u></b> .....	6-116
<b><u>Measurement Throughput Summary</u></b> .....	6-117
<b><u>Table 41 Typical Cycle Time (ms) for Measurement Completion</u></b> .....	6-117
<b><u>Table 42. Cycle Time vs IF Bandwidth</u></b> .....	6-118
<b><u>Table 43. Cycle Time vs Number of Points</u></b> .....	6-118
<b><u>Table 44. Data Transfer Time (ms)</u></b> .....	6-119
<b><u>Specifications: Front-Panel Jumpers</u></b> .....	6-119
<b><u>Table 45: Measurement Receiver Inputs (Rcvr A In, Rcvr B In)</u></b> .....	6-119
<b><u>Table 46: Reference Receiver Inputs (Rcvr R1, Rcvr R2)</u></b> .....	6-120
<b><u>Table 47: Reference Outputs (Reference 1 Source Out, Reference 2 Source Out)</u></b> .....	6-120
<b><u>Table 48: Source Outputs (Port 1 Source Out, Port 2 Source Out)</u></b> .....	6-121
<b><u>Table 49: Coupler Inputs (Port 1 Cplr Thru, Port 2 Cplr Thru)</u></b> .....	6-121
<b><u>Table 50: Coupler Outputs (Port 1 Cplr Arm, Port 2 Cplr Arm)</u></b> .....	6-121
<b><u>Test Set Block Diagrams</u></b> .....	6-122
<b><u>E8361A - Standard Configuration and Standard Power Range</u></b> .....	6-122
<b><u>Test Set with Option 014 Block Diagrams</u></b> .....	6-123
<b><u>E8361A - Option 014 Configurable Test Set and Standard Power Range</u></b> .....	6-123

This is a complete list of the E8361A network analyzer technical specifications.

- To view or print the Data Sheet (a condensed version of the specifications), visit our web site at <http://www.agilent.com/find/pna>, click "Library," and then click "PNA Series Microwave Network Analyzers Data Sheet."
- The uncertainty curves contained in this document apply only to the setup conditions listed. Please download our free Uncertainty Calculator from [http://www.agilent.com/find/na\\_calculator](http://www.agilent.com/find/na_calculator) to generate the curves for your PNA setup.

---

## Definitions

All specifications and characteristics apply over a 25 °C  $\pm$ 5 °C range (unless otherwise stated) and 90 minutes after the instrument has been turned on.

**Specification (spec.):** Warranted performance. Specifications include guardbands to account for the expected statistical performance distribution, measurement uncertainties, and changes in performance due to environmental conditions.

**Characteristic (char.):** A performance parameter that the product is expected to meet before it leaves the factory, but that is not verified in the field and is not covered by the product warranty. A characteristic includes the same guardbands as a specification.

**Typical (typ.):** Expected performance of an average unit which does not include guardbands. It is not covered by the product warranty.

**Nominal (nom.):** A general, descriptive term that does not imply a level of performance. It is not covered by the product warranty.

**Calibration:** The process of measuring known standards to characterize a network analyzer's systematic (repeatable) errors.

**Corrected (residual):** Indicates performance after **error correction** (calibration). It is determined by the quality of calibration standards and how well "known" they are, plus system repeatability, stability, and noise.

**Uncorrected (raw):** Indicates instrument performance without error correction. The uncorrected performance affects the stability of a **calibration**.

**Standard:** When referring to the analyzer, this includes no options unless noted otherwise.

## Corrected System Performance

The specifications in this section apply for measurements made with the E8361A analyzer with the following conditions:

- 10 Hz IF bandwidth
- No averaging applied to data

**Table 1. System Dynamic Range<sup>a</sup>**

Description	Specification (dB) at Test Port <sup>b</sup>	Typical (dB) at Direct Receiver Access Input <sup>c</sup>	Supplemental Information
<b>Dynamic Range (in a 10 Hz BW)</b>			
<b>Standard Configuration (E8361A - Standard)</b>			
10 MHz to 45 MHz <sup>d</sup>	63	NA	
45 MHz to 500 MHz <sup>e</sup>	87	NA	
500 MHz to 2 GHz	112	NA	
2 GHz to 10 GHz	112	NA	
10 GHz to 24 GHz	117	NA	
24 GHz to 30 GHz	106	NA	
30 GHz to 40 GHz	104	NA	
40 GHz to 45 GHz	98	NA	
45 GHz to 50 GHz	100	NA	
50 GHz to 60 GHz	97	NA	
60 GHz to 67 GHz	94	NA	
67 GHz to 70 GHz <sup>d</sup>	94	NA	
<b>Configurable Test Set (E8361A - Option 014 or Option 014 and 080)</b>			
10 MHz to 45 MHz <sup>d</sup>	63	99	
45 MHz to 500 MHz <sup>e</sup>	87	102	
500 MHz to 2 GHz	112	125.5	
2 GHz to 10 GHz	112	125	
10 GHz to 24 GHz	115	128	
24 GHz to 30 GHz	104	117.5	
30 GHz to 40 GHz	102	115	
40 GHz to 45 GHz	96	109	
45 GHz to 50 GHz	98	110.5	
50 GHz to 60 GHz	95	107	
60 GHz to 67 GHz	90	101	
67 GHz to 70 GHz <sup>d</sup>	90	100	

<sup>a</sup> The system dynamic range is calculated as the difference between the noise floor and the source maximum output power. The effective dynamic range must take measurement uncertainties and interfering signals into account.

<sup>b</sup> The test port system dynamic range is calculated as the difference between the test port noise floor and the source maximum output power. The effective dynamic range must take measurement uncertainties and interfering signals into account.

<sup>c</sup> The direct receiver access input system dynamic range is calculated as the difference between the receiver access input noise floor and the source maximum output power. The effective dynamic range must take measurement uncertainties and interfering signals into account. This set-up should only be used when the receiver input will never exceed its damage level. When the analyzer is in segment sweep mode, the analyzer can have predefined frequency segments which will output a higher power level when the extended dynamic range is required (i.e. devices with high insertion loss), and reduced power when receiver damage may occur (i.e. devices with low insertion loss). The extended range is only available in one-path transmission measurements.

<sup>d</sup> Typical performance.

<sup>e</sup> May be limited to 100 dB at particular frequencies below 500 MHz due to spurious receiver residuals. Methods are available to regain the full dynamic range.

---

**Note:** This E8361A document does NOT provide technical specifications for Receiver Dynamic Range.

---



---

**Note:** This E8361A document provides technical specifications for the following calibration kits only: 85056A, 85056D, 85056K, 85052B, 85052C, 85052D, 85050B, 85050C, 85050D, 85054B, 85054D, 85058B, 85058E, K11644A, P11644A, R11644A, and the X11644A.

---



## E8361A Corrected System Performance with 1.85mm Connectors

- To view or print the **Corrected System Performance with 1.85mm Connectors**, see the Data Sheet (a condensed version of the specifications) at <http://www.agilent.com/find/pna>. Click "Library," and then click "PNA Series Microwave Network Analyzers Data Sheet."
- Please download our free Uncertainty Calculator from [http://www.agilent.com/find/na\\_calculator](http://www.agilent.com/find/na_calculator) to generate the curves for your PNA setup.

## E8361A Corrected System Performance with 2.4mm Connectors

**Table 2.** 85056A Calibration Kit

### E8361A - Standard Configuration and Standard Power Range

Applies to the E8361A analyzers, 85056A (2.4mm) calibration kit, 85133F flexible test port cable set, and a full 2-port calibration. Also applies to the following condition:

Environmental temperature 23° ±3 °C, with < 1 °C deviation from calibration temperature

Description	Specification (dB)			
	45 MHz to 2 GHz	2 to 20 GHz	20 to 40 GHz	40 to 50 GHz
Directivity	42	42	38	36
Source Match	41	38	33	31
Load Match	42	42	37	35
Reflection Tracking	±0.001 +0.02/°C	±0.008 +0.02/°C	±0.020 +0.02/°C	±0.027 +0.03/°C
Transmission Tracking	±0.035 +0.02/°C	±0.060 +0.02/°C	±0.146 +0.02/°C	±0.181 +0.03/°C

## Transmission Uncertainty (Specifications)

### Magnitude

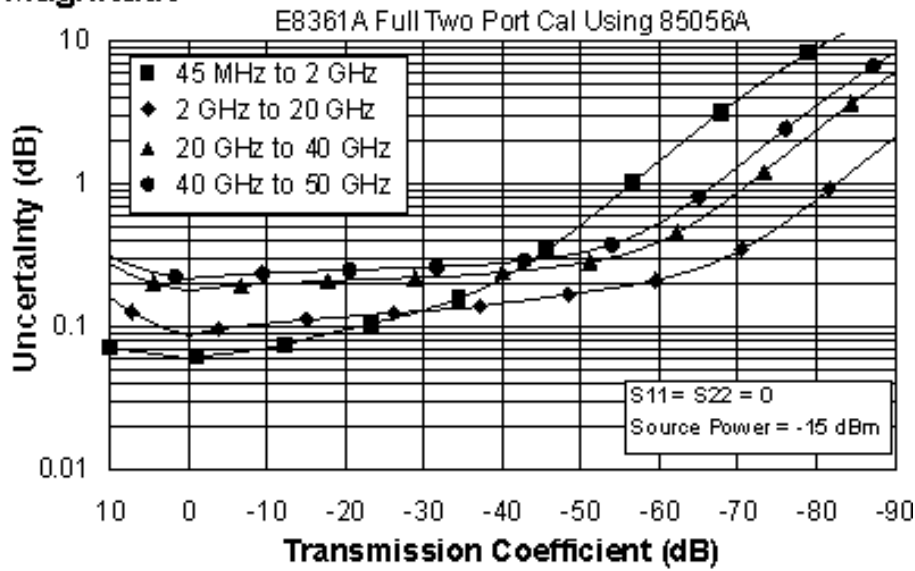

### Phase

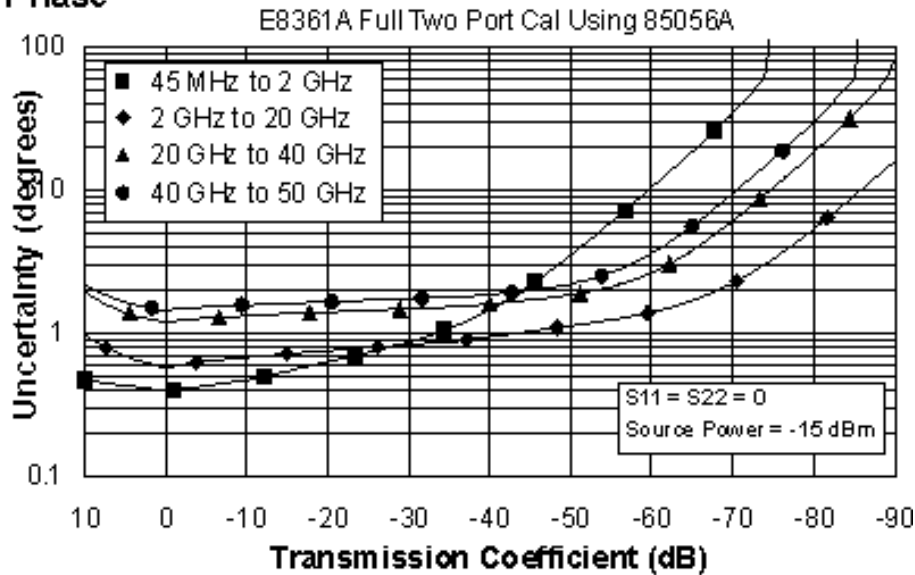

## Reflection Uncertainty (Specifications)

### Magnitude

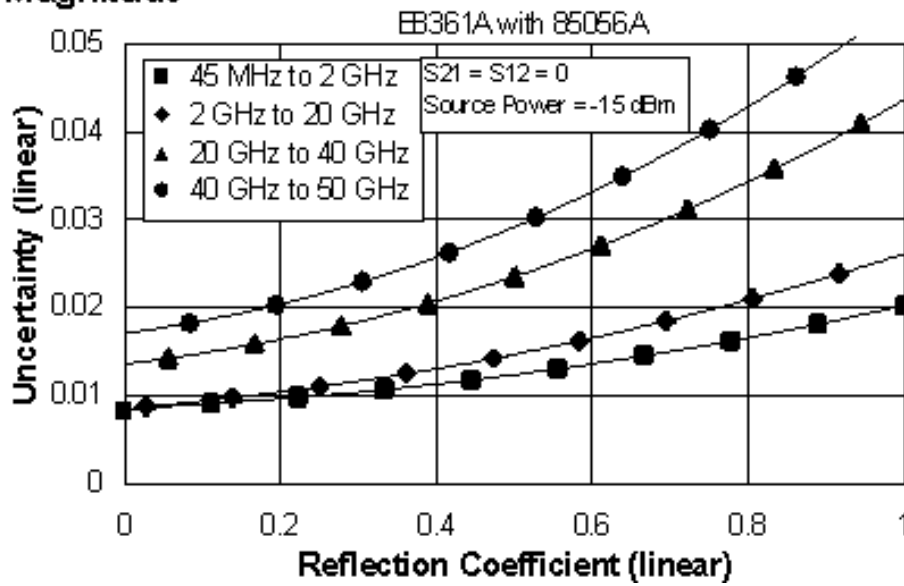

### Phase

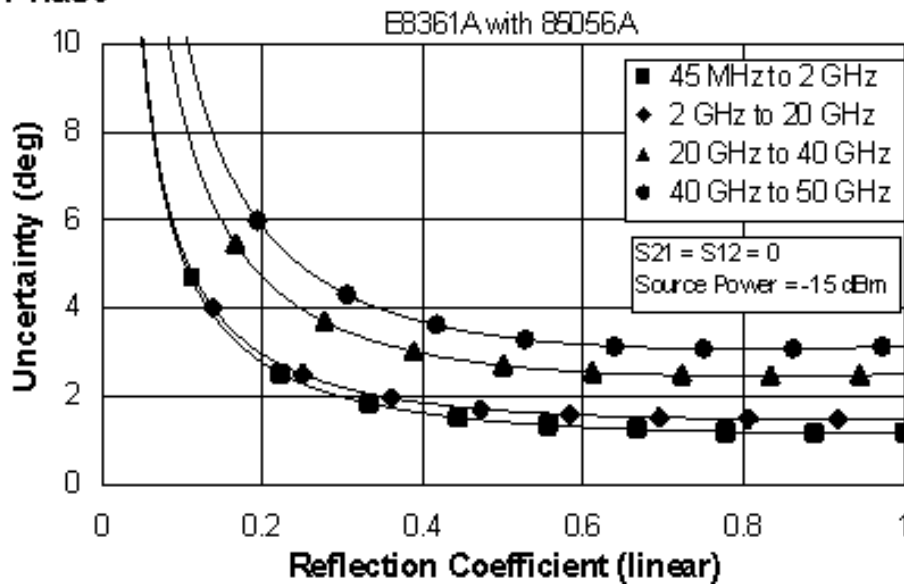

**Table 3. 85056A Calibration Kit**  
 E8361A - Fully Optioned (Option 014, and 080)  
 Configurable Test Set, and Frequency Offset Mode

Applies to the, E8361A analyzers, 85056A (2.4mm) calibration kit, 85133F flexible test port cable set, and a full 2-port calibration. Also applies to the following condition:

Environmental temperature 23° ±3 °C, with < 1 °C deviation from calibration temperature

Description	Specification (dB)			
	45 MHz to 2 GHz	2 to 20 GHz	20 to 40 GHz	40 to 50 GHz
Directivity	42	42	38	36
Source Match	41	38	33	31
Load Match	42	42	37	35
Reflection Tracking	±0.001 +0.02/°C	±0.008 +0.02/°C	±0.020 +0.02/°C	±0.027 +0.03/°C
Transmission Tracking	±0.038 +0.02/°C	±0.064 +0.02/°C	±0.130 +0.02/°C	±0.157 +0.03/°C

## Transmission Uncertainty (Specifications)

### Magnitude

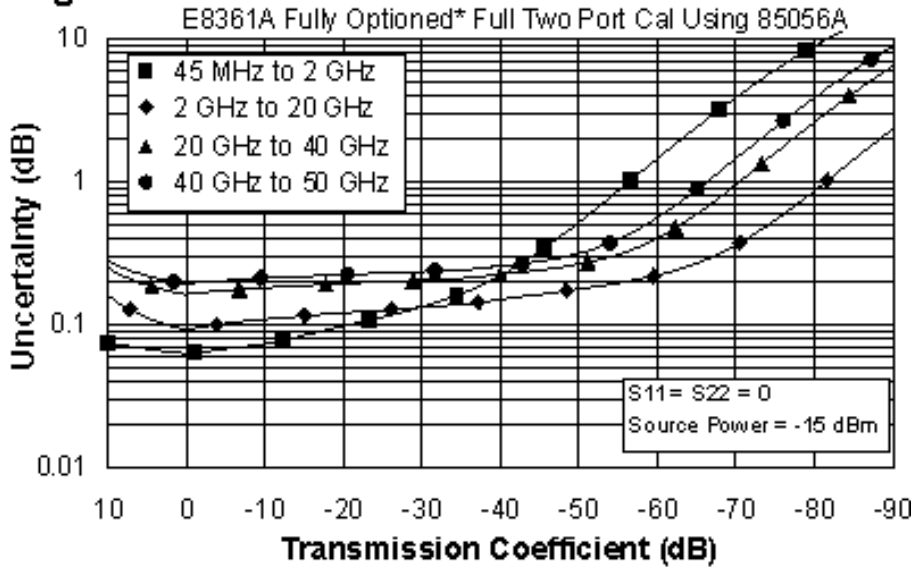

### Phase

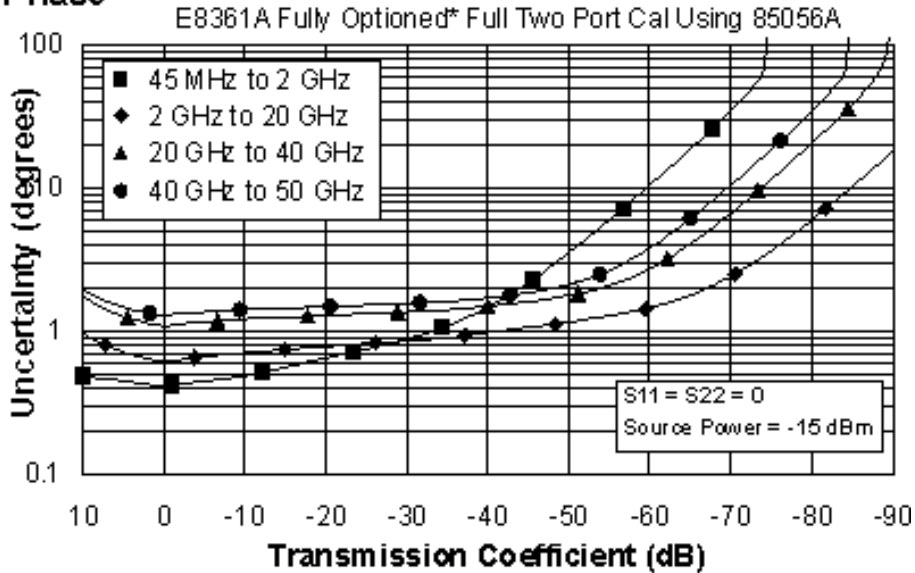

\* Configurable Test Set, and Frequency Offset Mode (E8361A - Option 014, and 080)

**Reflection Uncertainty (Specifications)**

**Magnitude**

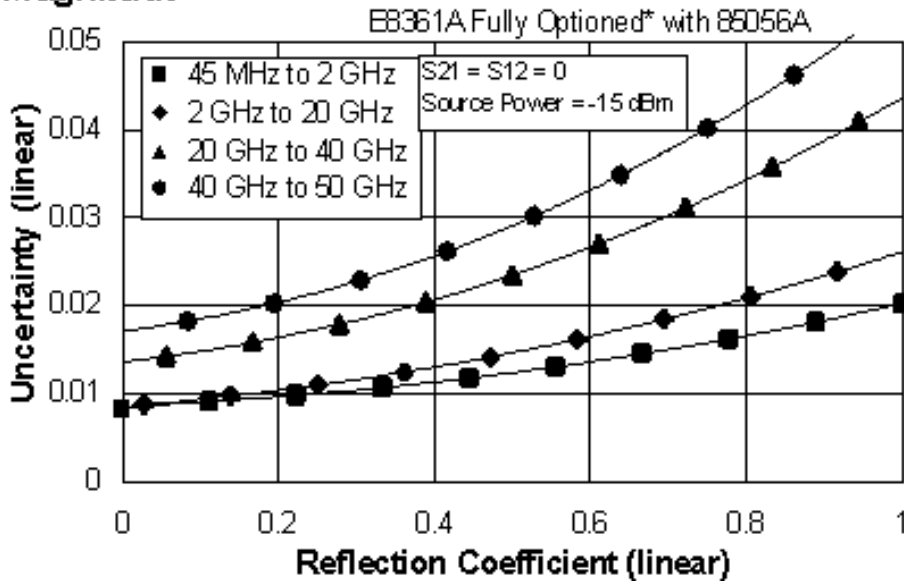

**Phase**

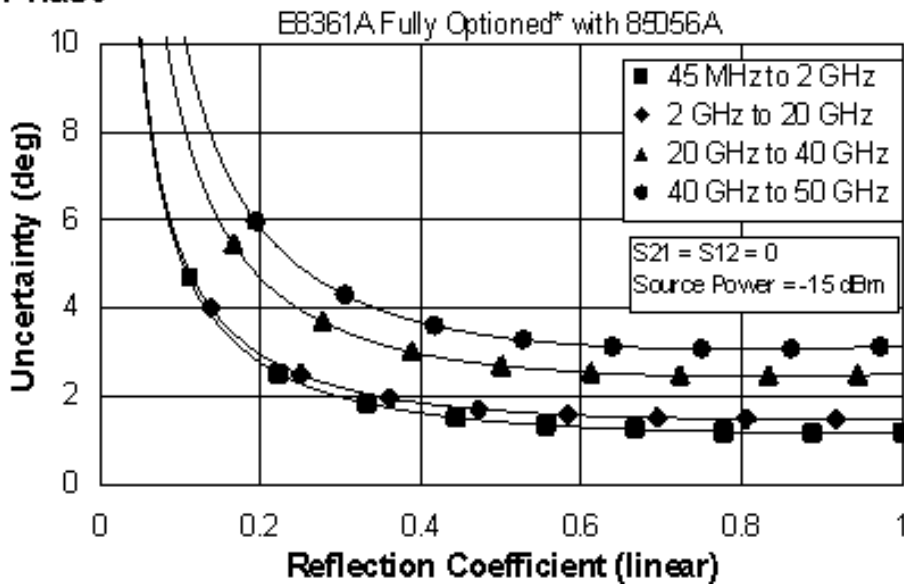

\* Configurable Test Set, and Frequency Offset Mode (E8361A - Option 014, and 080)

**Table 4. 85056D Calibration Kit**  
**E8361A - Standard Configuration and Standard Power Range**

Applies to the, E8361A analyzers, 85056D (2.4mm) calibration kit, 85133F flexible test port cable set, and a full 2-port calibration. Also applies to the following condition:

Environmental temperature 23° ±3 °C, with < 1 °C deviation from calibration temperature

Description	Specification (dB)			
	45 MHz to 2 GHz	2 to 20 GHz	20 to 40 GHz	40 to 50 GHz
Directivity	42	34	26	26
Source Match	40	30	24	23
Load Match	42	33	25	25
Reflection Tracking	±0.002 +0.02/°C	±0.029 +0.02/°C	±0.079 +0.02/°C	±0.075 +0.03/°C
Transmission Tracking	±0.041 +0.02/°C	±0.146 +0.02/°C	±0.480 +0.02/°C	±0.489 +0.03/°C

## Transmission Uncertainty (Specifications)

### Magnitude

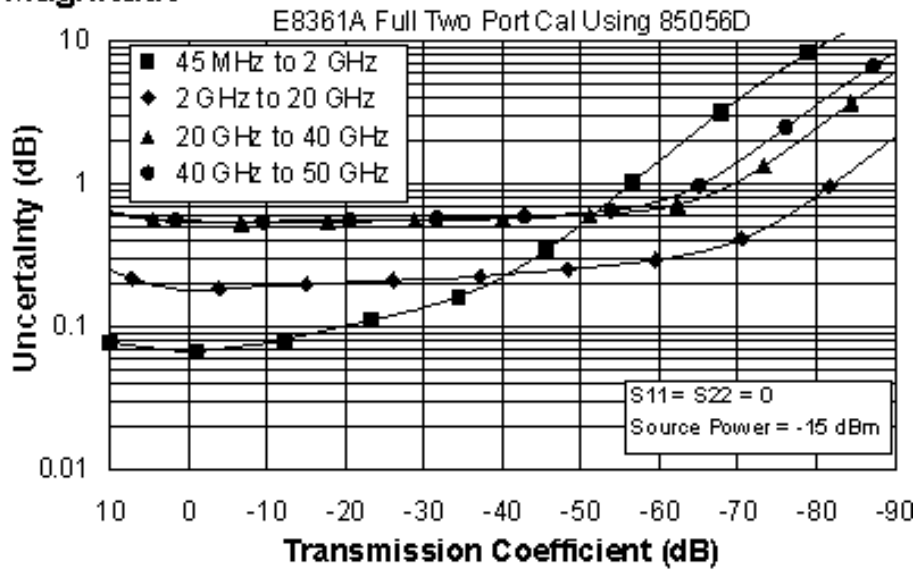

### Phase

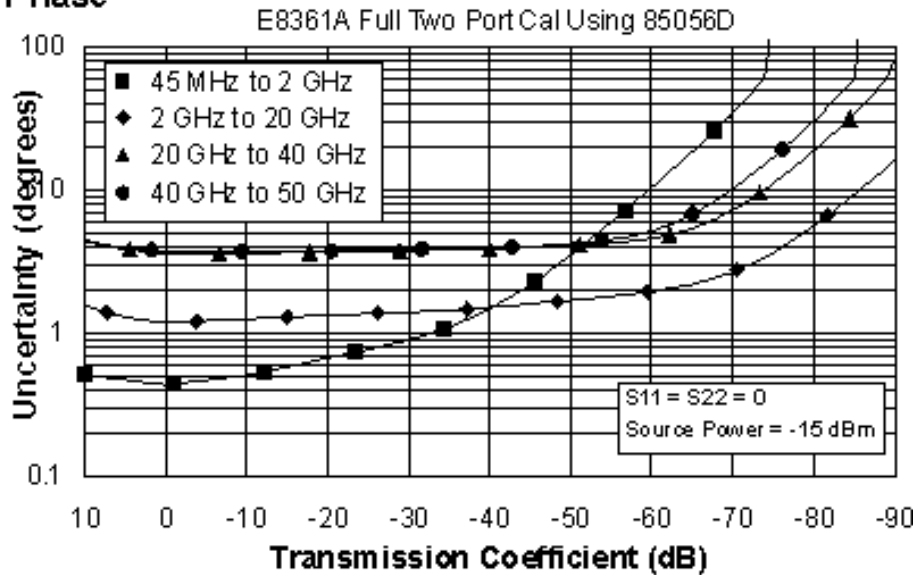



Magnitude

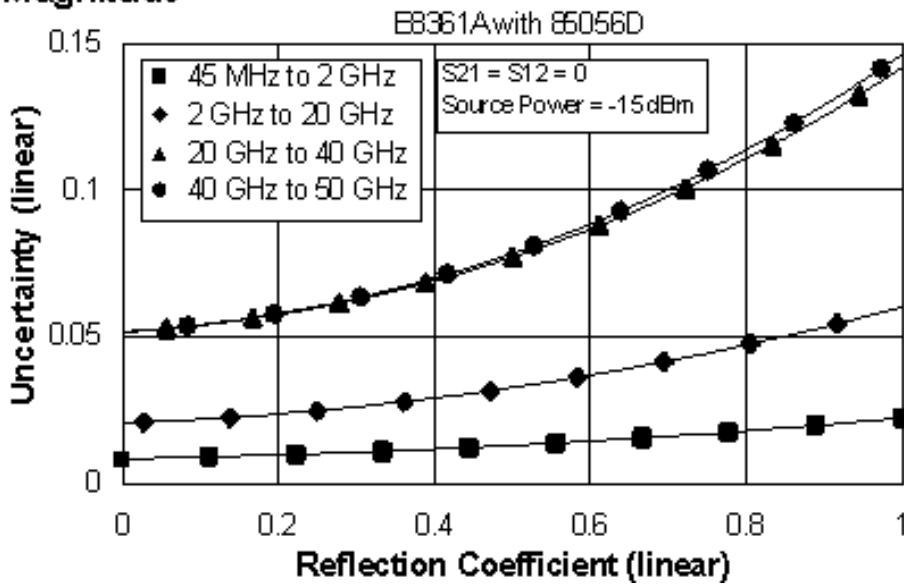

Phase

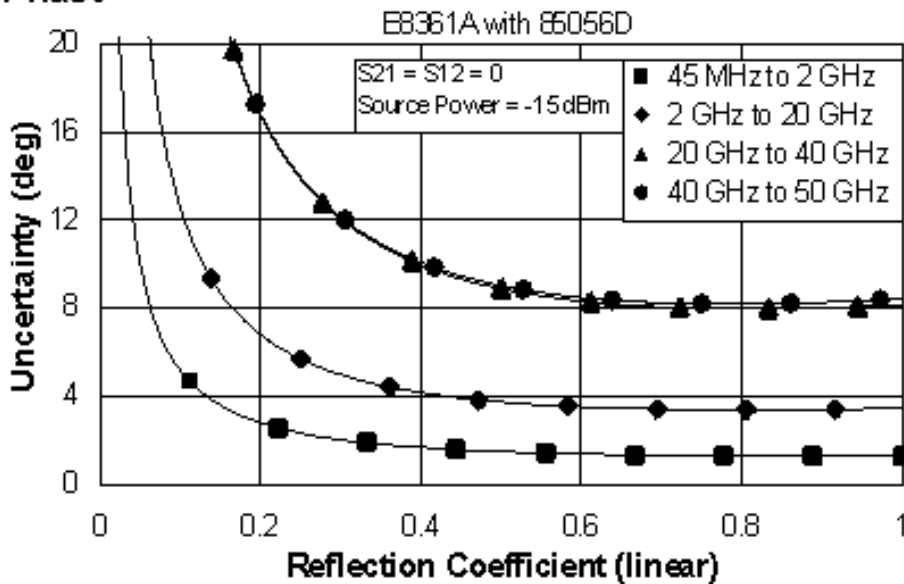

**Table 5. 85056D Calibration Kit**  
 E8361A - Fully Optioned (Option 014, and 080)  
 Configurable Test Set, and Frequency Offset Mode

Applies to the, E8361A analyzers, 85056D (2.4mm) calibration kit, 85133F flexible test port cable set, and a full 2-port calibration. Also applies to the following condition:

Environmental temperature 23° ±3 °C, with < 1 °C deviation from calibration temperature

Description	Specification (dB)			
	45 MHz to 2 GHz	2 to 20 GHz	20 to 40 GHz	40 to 50 GHz
Directivity	42	34	26	26
Source Match	40	30	24	23
Load Match	42	33	25	25
Reflection Tracking	±0.002 +0.02/°C	±0.029 +0.02/°C	±0.079 +0.02/°C	±0.075 +0.03/°C
Transmission Tracking	±0.044 +0.02/°C	±0.158 +0.02/°C	±0.428 +0.02/°C	±0.426 +0.03/°C

## Transmission Uncertainty (Specifications)

### Magnitude

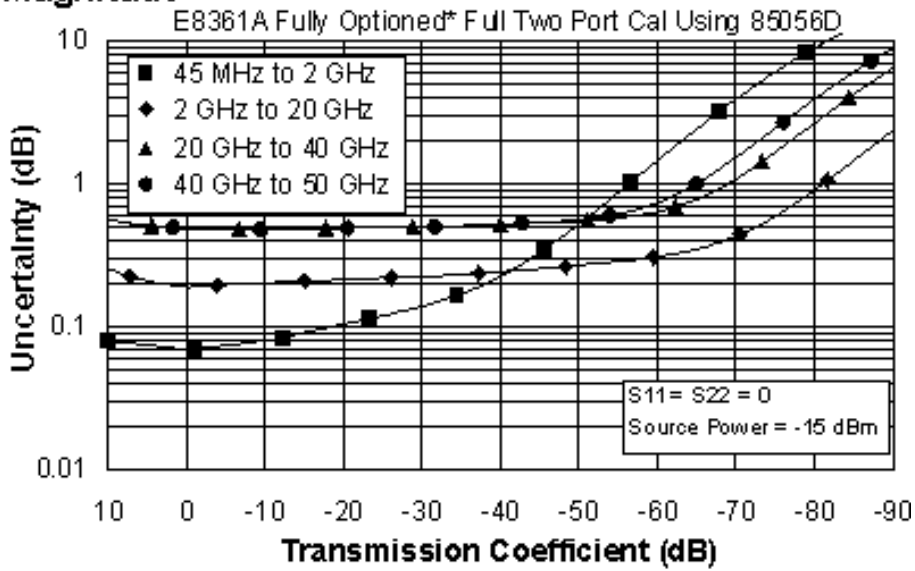

### Phase

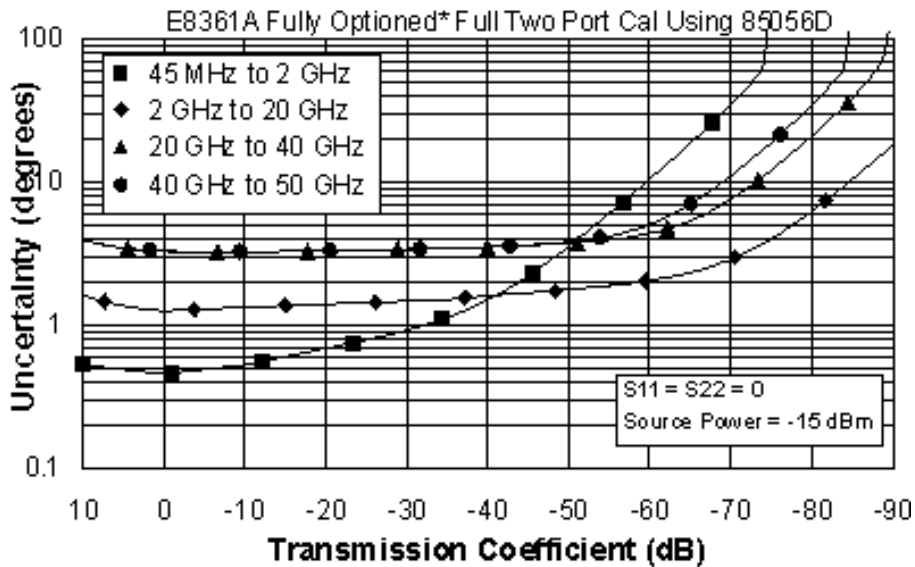

\* Configurable Test Set, and Frequency Offset Mode (E8361A - Option 014, and 080)

**Reflection Uncertainty (Specifications)**

**Magnitude**

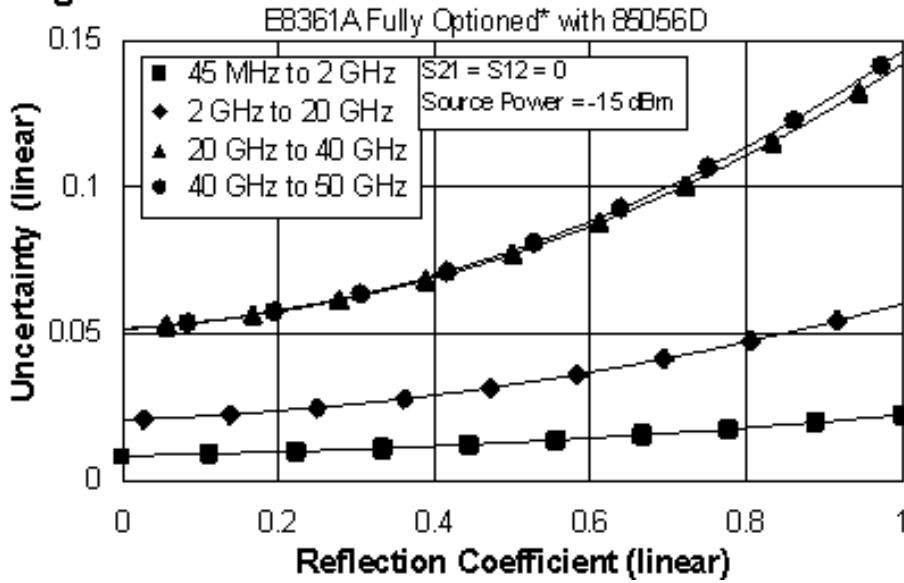

**Phase**

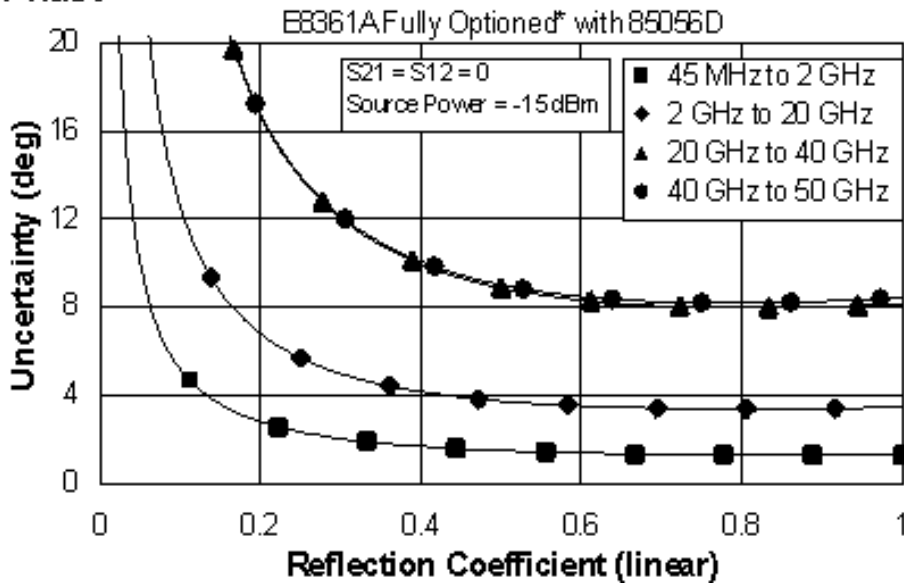

\* Configurable Test Set, and Frequency Offset Mode (E8361A - Option 014, and 080)

## E8361A Corrected System Performance with 2.92mm Connectors

**Table 6.** 85056K Calibration Kit

### E8361A - Standard Configuration and Standard Power Range

Applies to the, E8361A analyzers, 85056K (2.92mm) calibration kit, 85133F flexible test port cable set, and a full 2-port calibration. Also applies to the following condition:

Environmental temperature  $23^{\circ} \pm 3^{\circ} \text{C}$ , with  $< 1^{\circ} \text{C}$  deviation from calibration temperature

Description	Specification (dB)		
	0.045 to 2 GHz	2 to 20 GHz	20 to 40 GHz
Directivity	42	42	40
Source Match	40	40	35
Load Match	41	41	37
Reflection Tracking	$\pm 0.018$ $+0.02/^{\circ}\text{C}$	$\pm 0.018$ $+0.02/^{\circ}\text{C}$	$\pm 0.067$ $+0.03/^{\circ}\text{C}$
Transmission Tracking	$\pm 0.040$ $+0.02/^{\circ}\text{C}$	$\pm 0.052$ $+0.02/^{\circ}\text{C}$	$\pm 0.127$ $+0.03/^{\circ}\text{C}$

## Transmission Uncertainty (Specifications)

### Magnitude

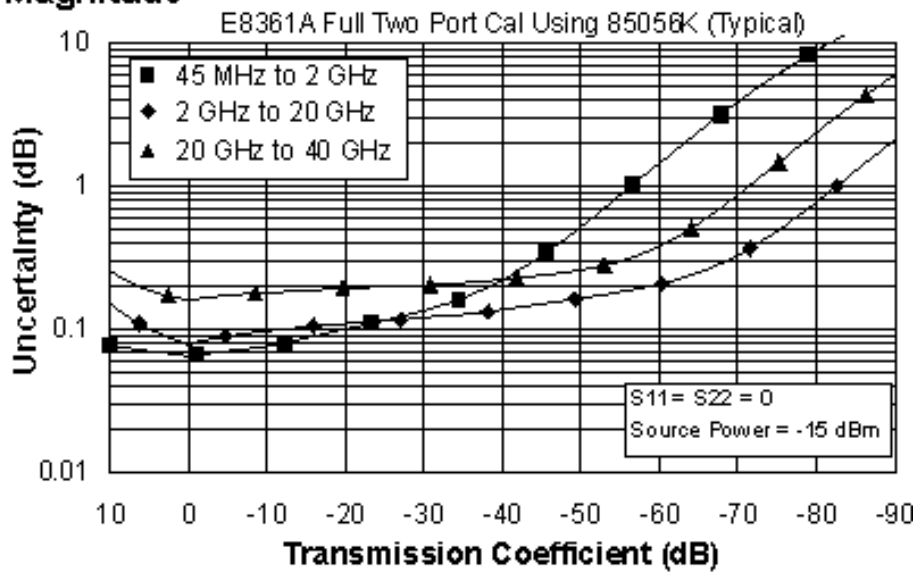

### Phase

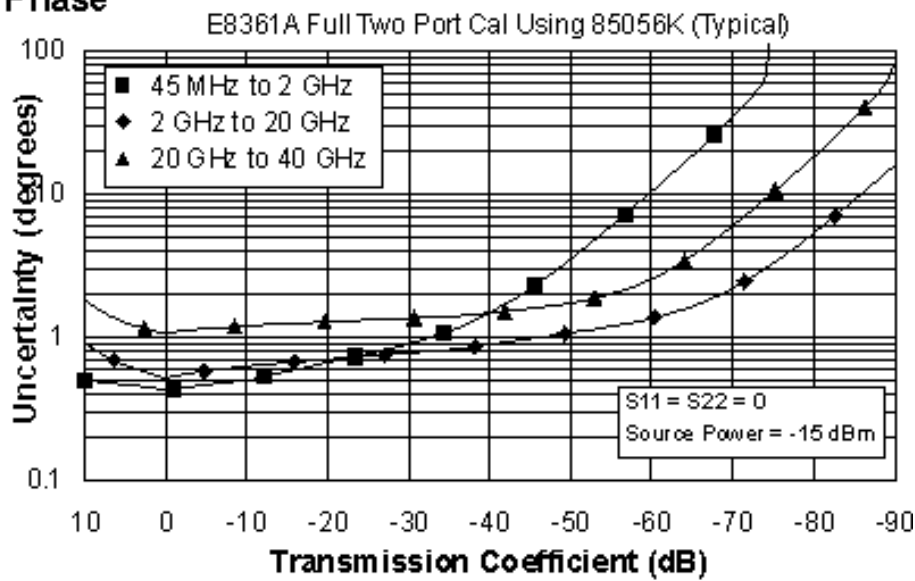

Reflection Uncertainty (Specifications)

Magnitude

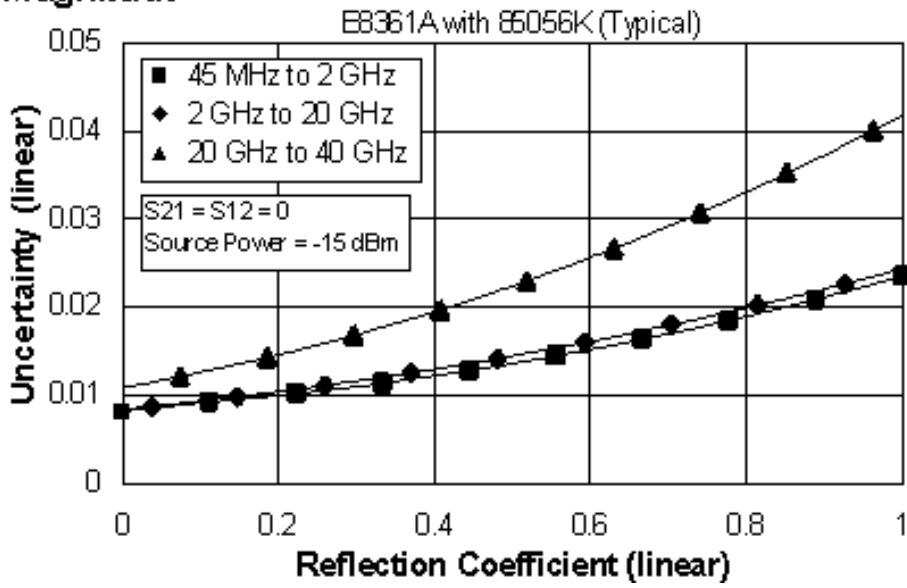

Phase

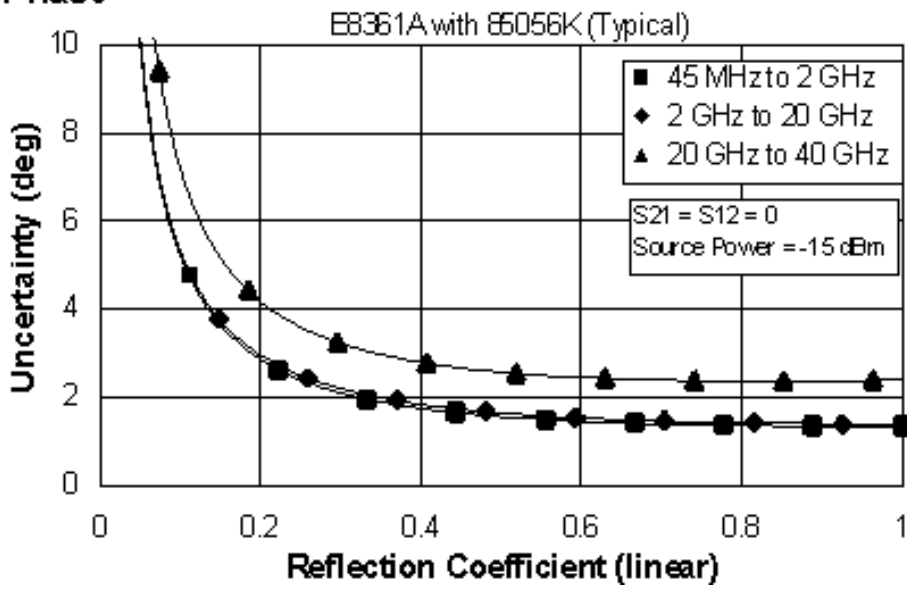

**Table 7. 85056K Calibration Kit**  
 E8361A - Fully Optioned (Option 014, and 080)  
 Configurable Test Set, and Frequency Offset Mode

Applies to the, E8361A analyzers, 85056K (2.92mm) calibration kit, 85133F flexible test port cable set, and a full 2-port calibration. Also applies to the following condition:

Environmental temperature 23° ±3 °C, with < 1 °C deviation from calibration temperature

Description	Specification (dB)		
	0.045 to 2 GHz	2 to 20 GHz	20 to 40 GHz
Directivity	42	42	40
Source Match	40	40	35
Load Match	41	41	37
Reflection Tracking	±0.018 +0.02/°C	±0.018 +0.02/°C	±0.067 +0.03/°C
Transmission Tracking	±0.043 +0.02/°C	±0.056 +0.02/°C	±0.112 +0.03/°C



## Transmission Uncertainty (Specifications)

### Magnitude

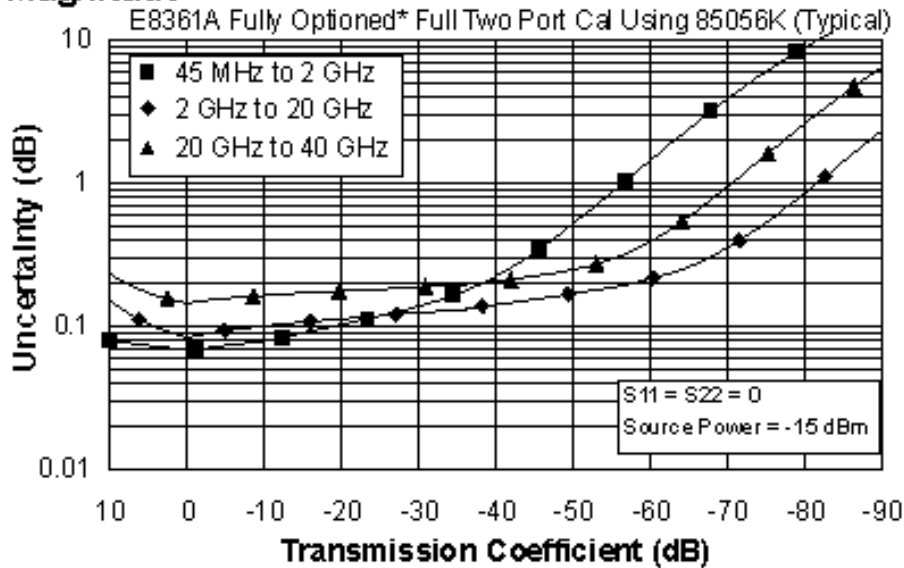

### Phase

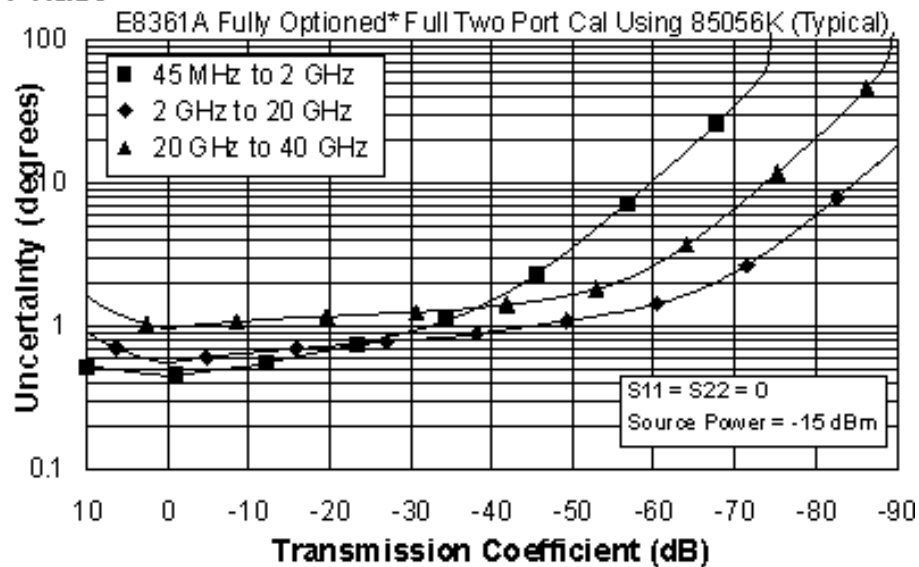

\* Configurable Test Set, and Frequency Offset Mode (E8361A - Option 014, and 080)

**Reflection Uncertainty (Specifications)**

**Magnitude**

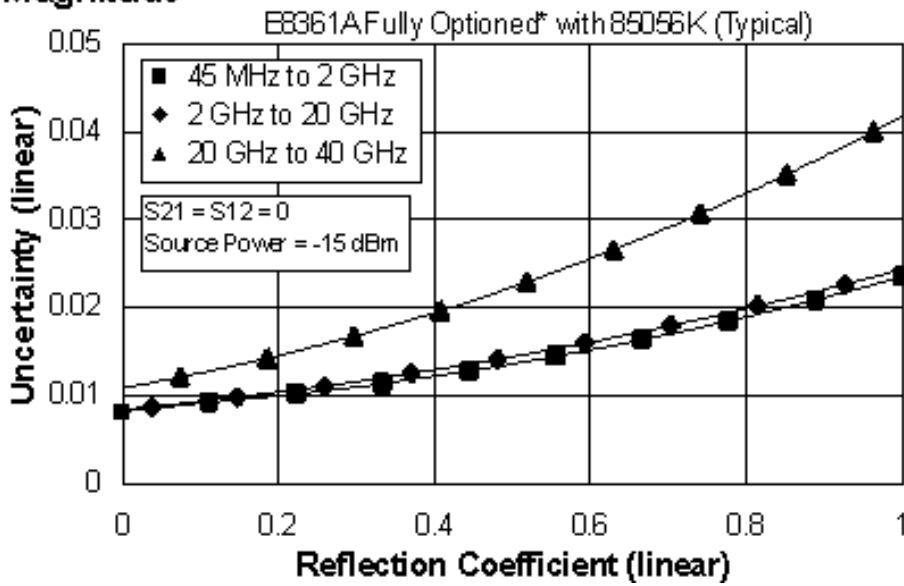

**Phase**

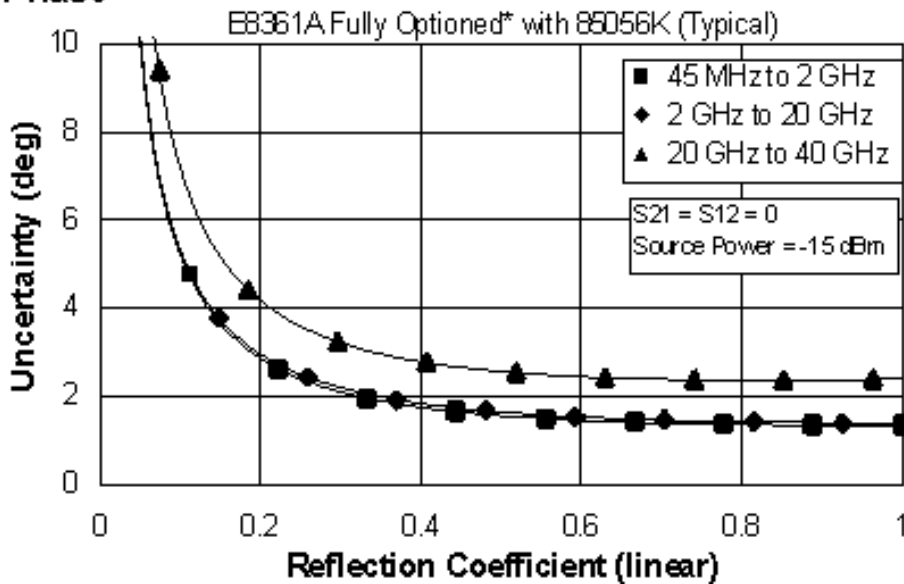

\* Configurable Test Set, and Frequency Offset Mode (E8361A - Option 014, and 080)

## E8361A Corrected System Performance with 3.5mm Connectors

**Table 8.** 85052B Calibration Kit

### E8361A - Standard Configuration and Standard Power Range

Applies to the, E8361A analyzers, 85052B (3.5mm) calibration kit, 85131F flexible test port cable set, and a full 2-port calibration. Also applies to the following condition:

Environmental temperature  $23^{\circ} \pm 3^{\circ} \text{C}$ , with  $< 1^{\circ} \text{C}$  deviation from calibration temperature

Description	Specification (dB)		
	45 MHz to 2 GHz	2 to 20 GHz	20 to 26.5 GHz
Directivity	48	44	44
Source Match	40	31	31
Load Match	48	44	44
Reflection Tracking	$\pm 0.003$ $+0.02/^{\circ}\text{C}$	$\pm 0.006$ $+0.02/^{\circ}\text{C}$	$\pm 0.006$ $+0.03/^{\circ}\text{C}$
Transmission Tracking	$\pm 0.035$ $+0.02/^{\circ}\text{C}$	$\pm 0.106$ $+0.02/^{\circ}\text{C}$	$\pm 0.131$ $+0.03/^{\circ}\text{C}$

## Transmission Uncertainty (Specifications)

### Magnitude

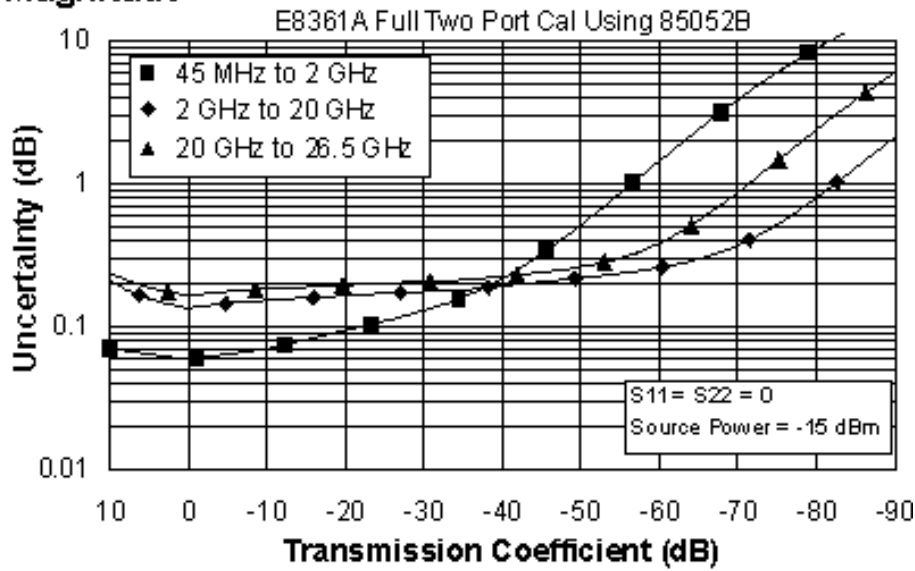

### Phase

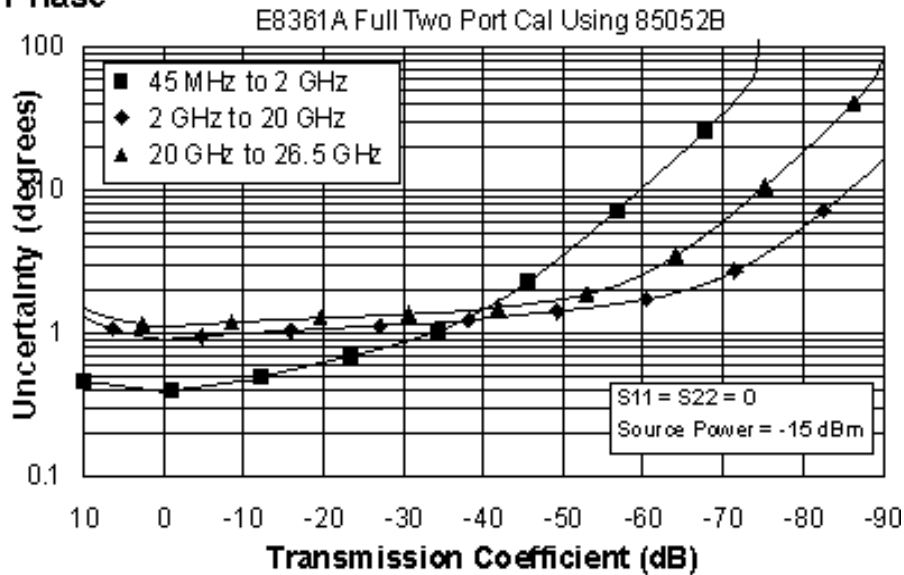

Reflection Uncertainty (Specifications)

Magnitude

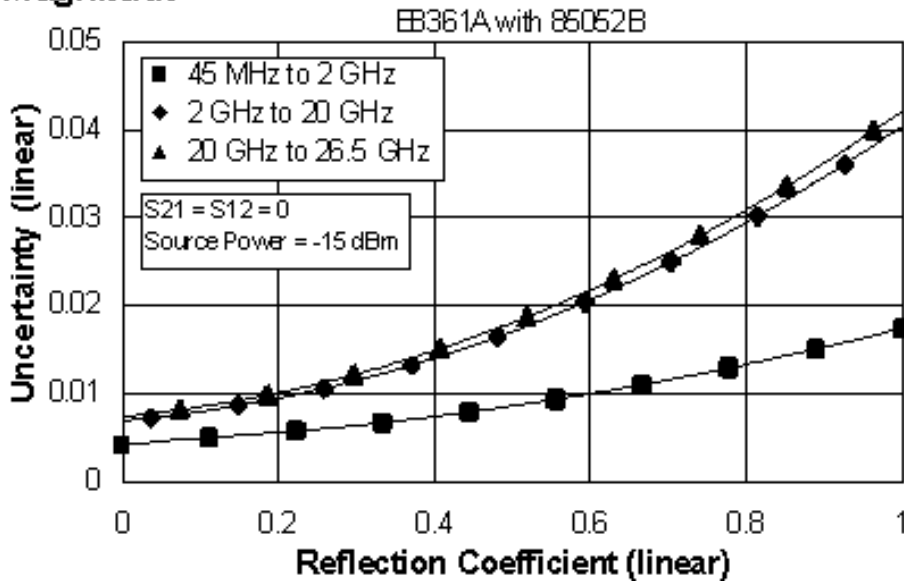

Phase

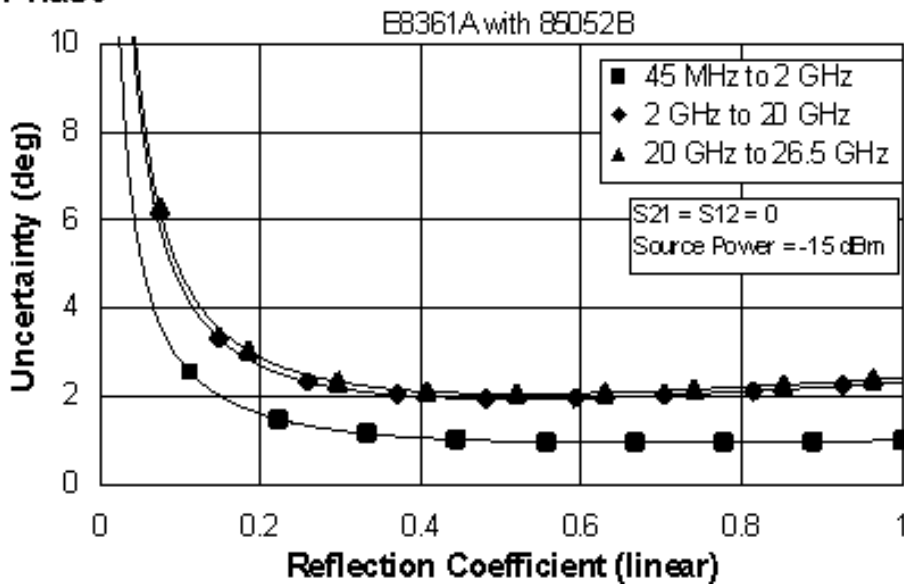

**Table 9. 85052B Calibration Kit**  
 E8361A - Fully Optioned (Option 014, and 080)  
 Configurable Test Set, and Frequency Offset Mode

Applies to the, E8361A analyzers, 85052B (3.5mm) calibration kit, 85131F flexible test port cable set, and a full 2-port calibration. Also applies to the following condition:

Environmental temperature 23° ±3 °C, with < 1 °C deviation from calibration temperature

Description	Specification (dB)		
	45 MHz to 2 GHz	2 to 20 GHz	20 to 26.5 GHz
Directivity	48	44	44
Source Match	40	31	31
Load Match	48	44	44
Reflection Tracking	±0.003 +0.02/°C	±0.006 +0.02/°C	±0.006 +0.03/°C
Transmission Tracking	±0.038 +0.02/°C	±0.113 +0.02/°C	±0.121 +0.03/°C

## Transmission Uncertainty (Specifications)

### Magnitude

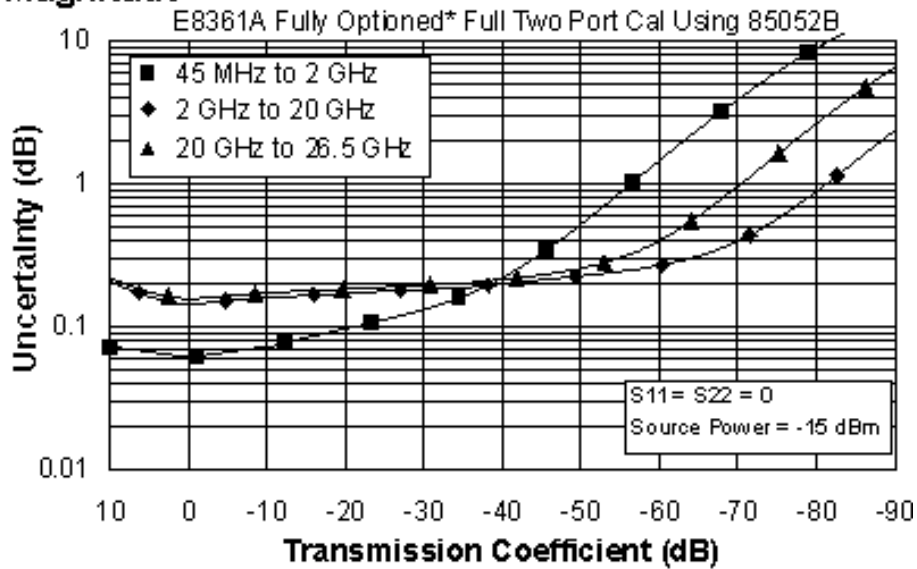

### Phase

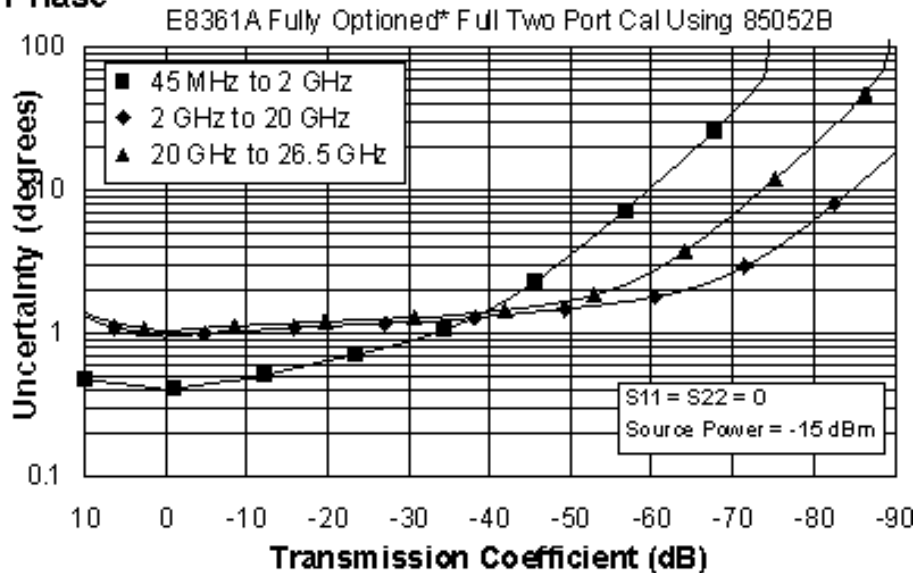

\* Configurable Test Set, and Frequency Offset Mode  
(E8361A - Option 014, and 080)

## Reflection Uncertainty (Specifications)

### Magnitude

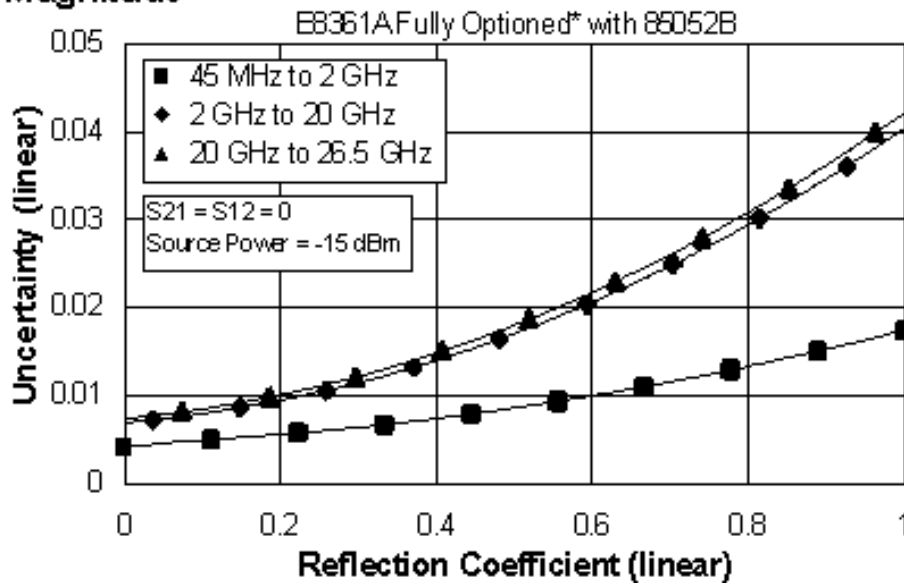

### Phase

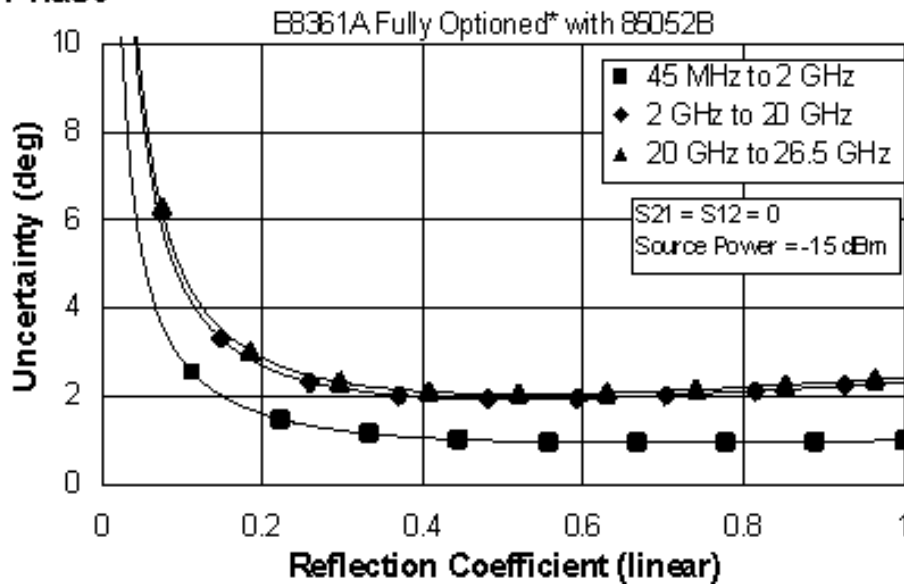

\* Configurable Test Set, and Frequency Offset Mode  
(E8361A - Option 014, and 080)



**Table 10. 85052C Calibration Kit  
E8361A - Standard Configuration and Standard Power Range**

Applies to the, E8361A analyzers, 85052C (3.5mm) calibration kit, 85131F flexible test port cable set, and a full 2-port calibration. Also applies to the following condition:

Environmental temperature 23° ±3 °C, with < 1 °C deviation from calibration temperature

Description	Specification (dB)		
	45 MHz to 2 GHz	2 to 20 GHz	20 to 26.5 GHz
Directivity	48	50	50
Source Match	40	50	50
Load Match	48	50	50
Reflection Tracking	±0.003 +0.02/°C	±0.000 +0.02/°C	±0.000 +0.03/°C
Transmission Tracking	±0.035 +0.02/°C	±0.017 +0.02/°C	±0.023 +0.03/°C

## Transmission Uncertainty (Specifications)

### Magnitude

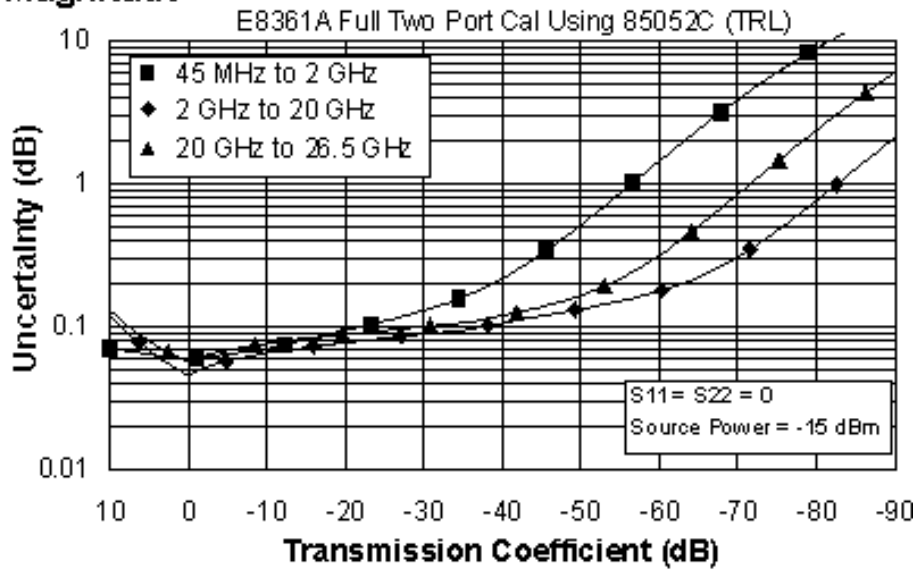

### Phase

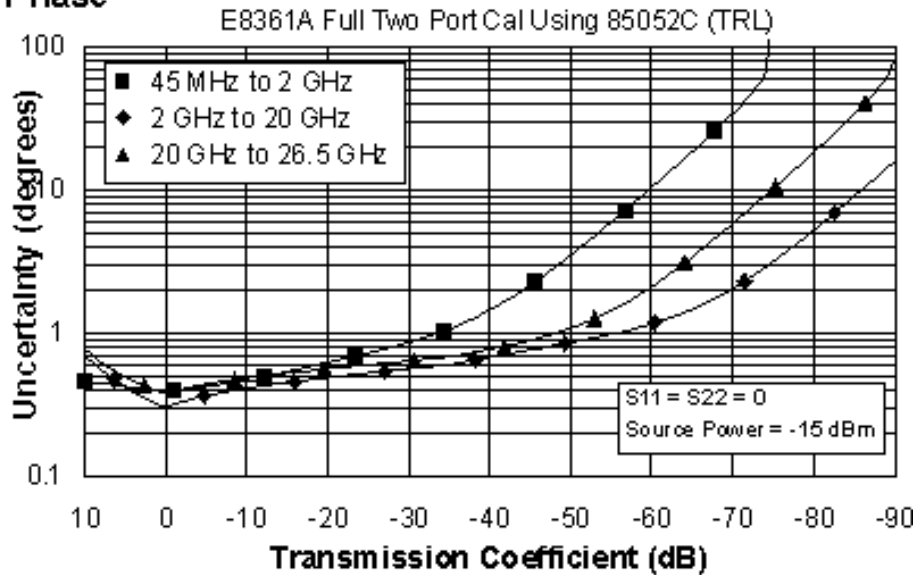

Reflection Uncertainty (Specifications)

Magnitude

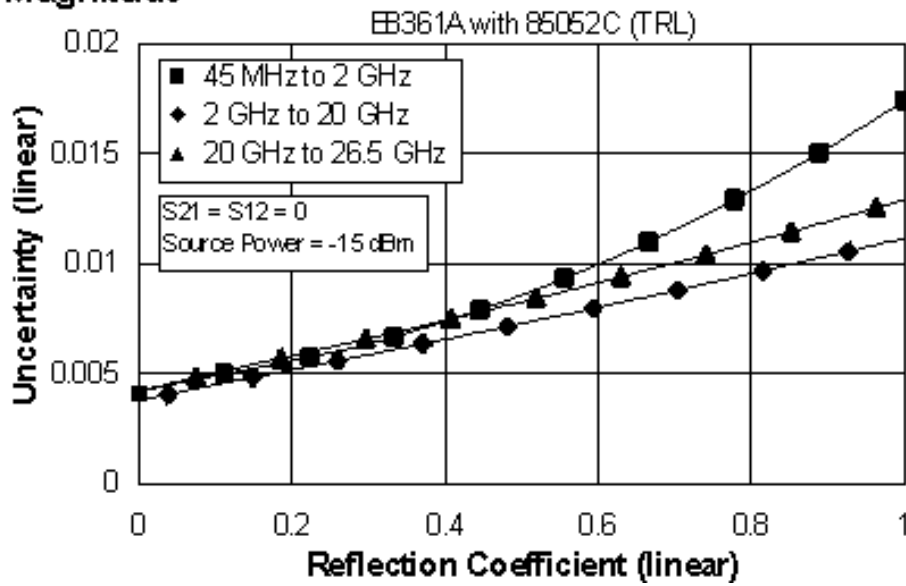

Phase

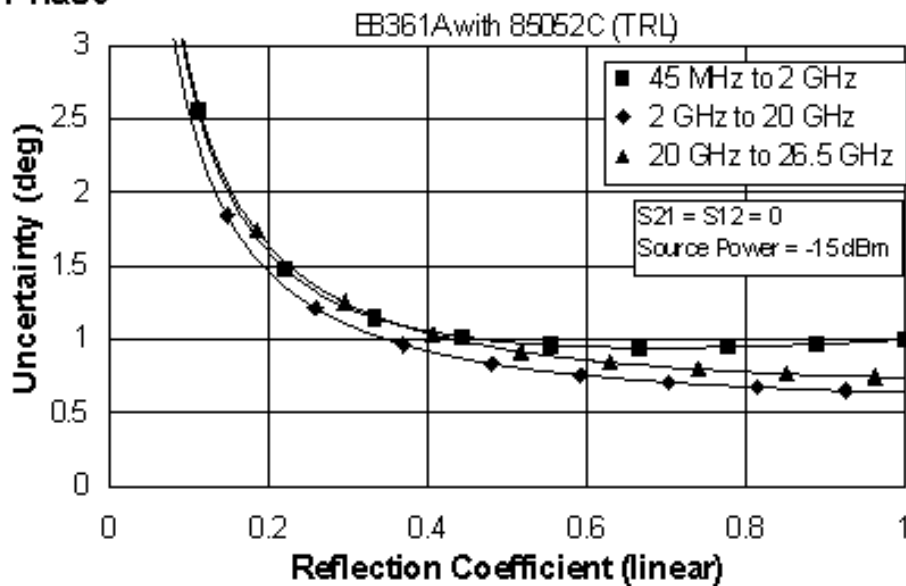

**Table 11. 85052C Calibration Kit**  
 E8361A - Fully Optioned (Option 014, and 080)  
 Configurable Test Set and Frequency Offset Mode

Applies to the, E8361A analyzers, 85052C (3.5mm) calibration kit, 85131F flexible test port cable set, and a full 2-port calibration. Also applies to the following condition:

Environmental temperature 23° ±3 °C, with < 1 °C deviation from calibration temperature

Description	Specification (dB)		
	45 MHz to 2 GHz	2 to 20 GHz	20 to 26.5 GHz
Directivity	48	50	50
Source Match	40	50	50
Load Match	48	50	50
Reflection Tracking	±0.003 +0.02/°C	±0.000 +0.02/°C	±0.000 +0.03/°C
Transmission Tracking	±0.038 +0.02/°C	±0.019 +0.02/°C	±0.020 +0.03/°C

## Transmission Uncertainty (Specifications)

### Magnitude

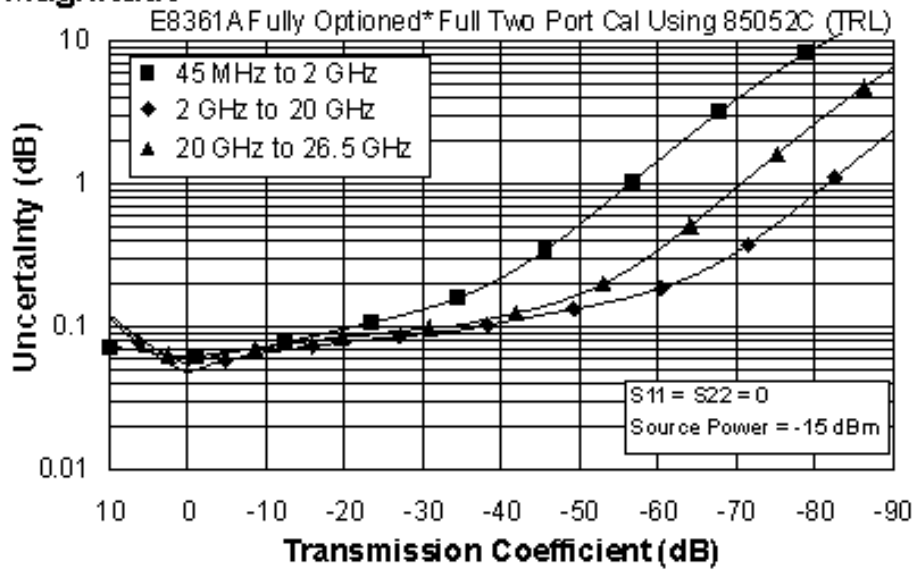

### Phase

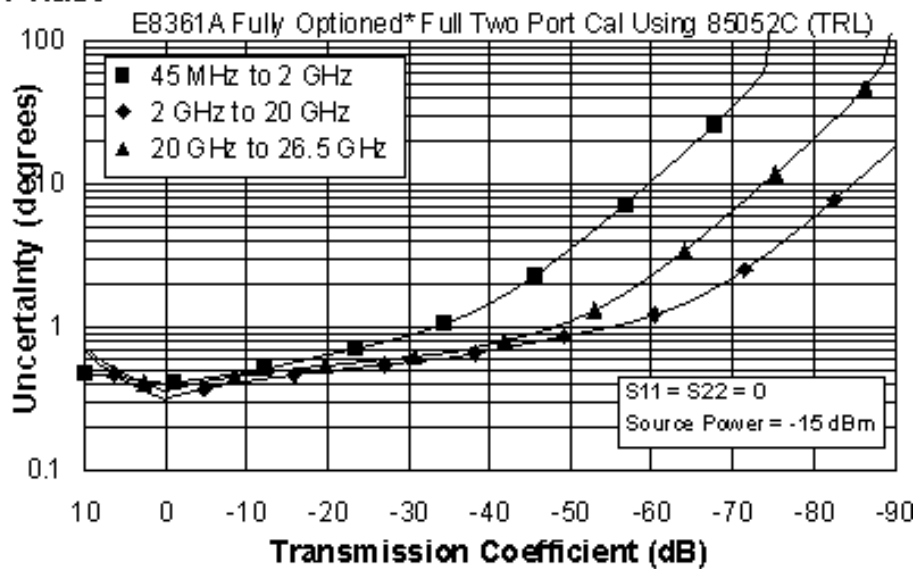

\* Configurable Test Set, and Frequency Offset Mode (E8361A - Option 014, and 080)

**Reflection Uncertainty (Specifications)**

**Magnitude**

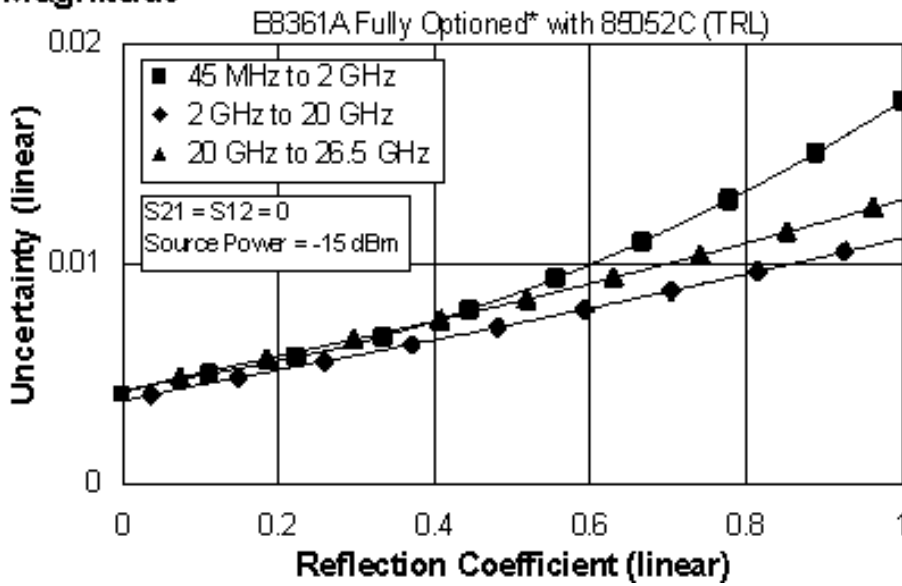

**Phase**

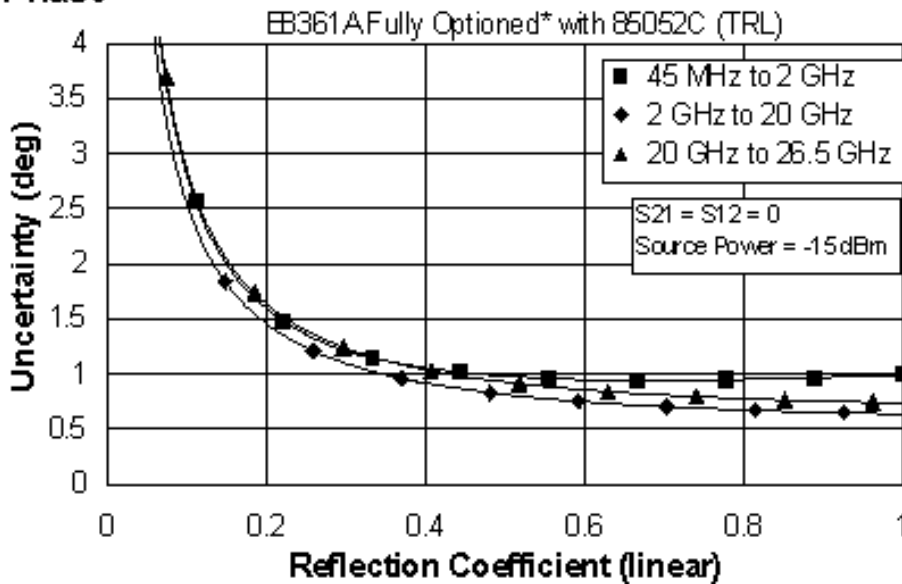

\* Configurable Test Set, and Frequency Offset Mode (E8361A - Option 014, and 080)

**Table 12. 85052D Calibration Kit**  
**E8361A - Standard Configuration and Standard Power Range**

Applies to the, E8361A analyzers, 85052D (3.5mm) calibration kit, 85131F flexible test port cable set, and a full 2-port calibration. Also applies to the following condition:

Environmental temperature 23° ±3 °C, with < 1 °C deviation from calibration temperature

Description	Specification (dB)		
	45 MHz to 2 GHz	2 to 20 GHz	20 to 26.5 GHz
Directivity	42	36	30
Source Match	37	28	25
Load Match	42	36	30
Reflection Tracking	±0.003 +0.02/°C	±0.008 +0.02/°C	±0.011 +0.03/°C
Transmission Tracking	±0.052 +0.02/°C	±0.158 +0.02/°C	±0.314 +0.03/°C

## Transmission Uncertainty (Specifications)

### Magnitude

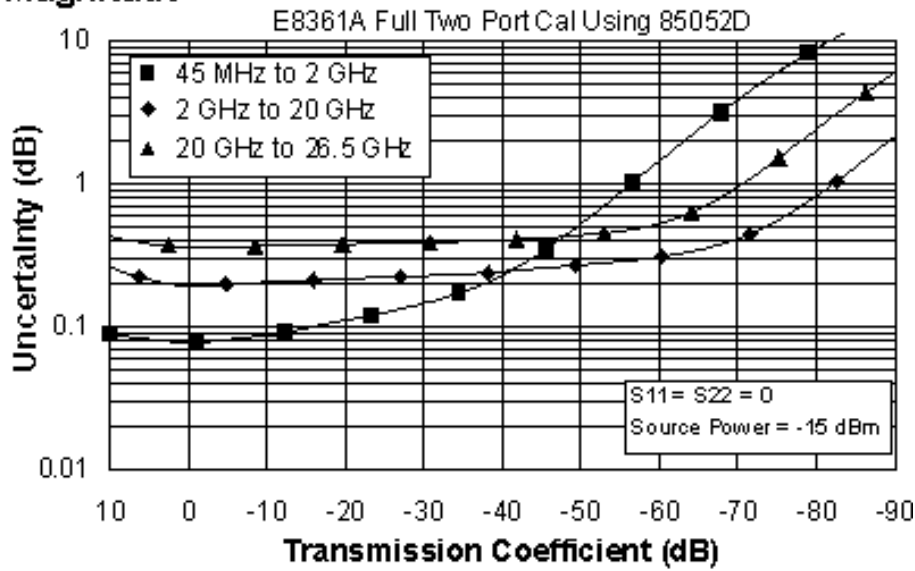

### Phase

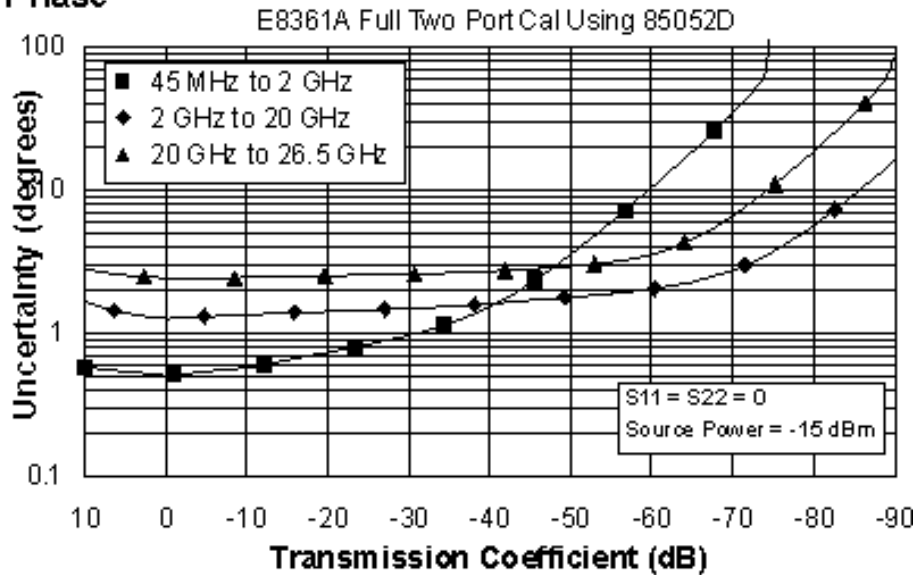



Reflection Uncertainty (Specifications)

Magnitude

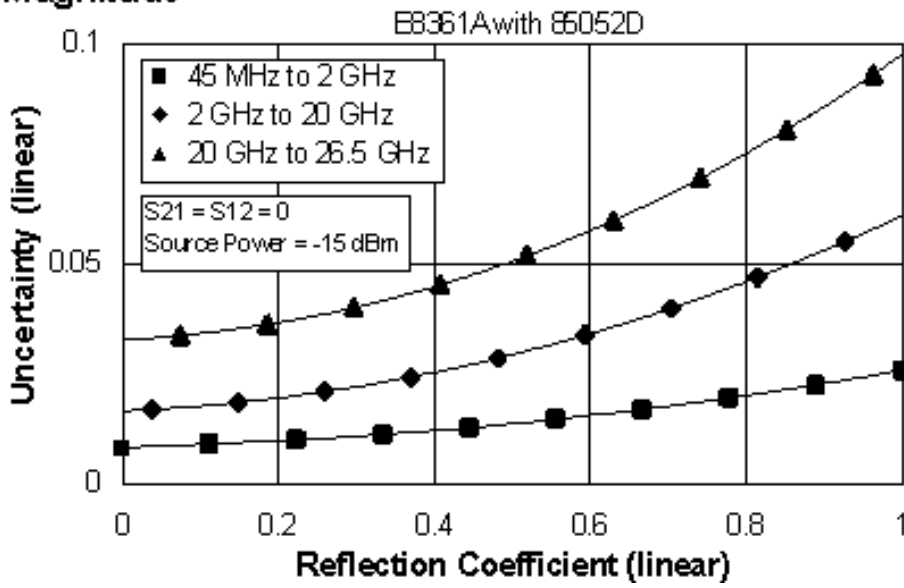

Phase

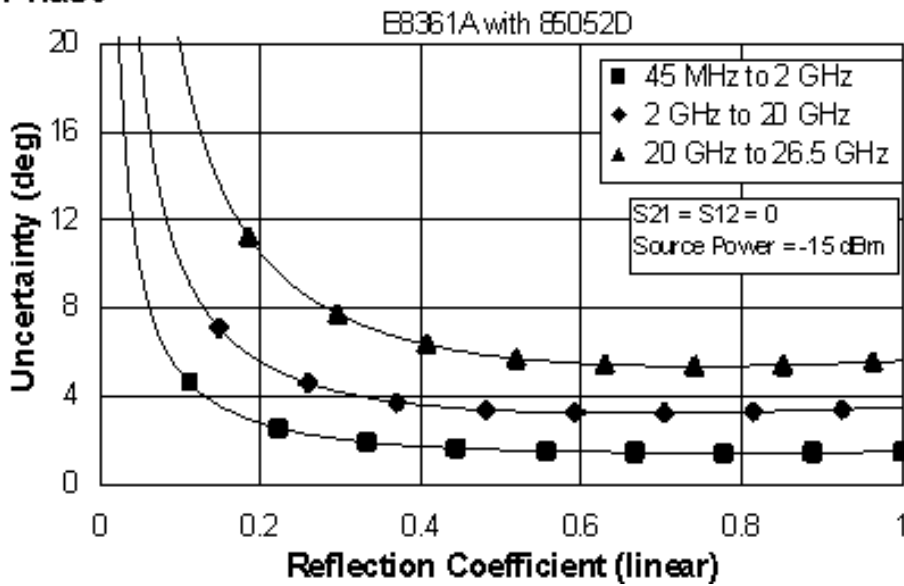

**Table 13. 85052D Calibration Kit**  
 E8361A - Fully Optioned (Option 014, and 080)  
 Configurable Test Set, and Frequency Offset Mode

Applies to the, E8361A analyzers, 85052D (3.5mm) calibration kit, 85131F flexible test port cable set, and a full 2-port calibration. Also applies to the following condition:

Environmental temperature 23° ±3 °C, with < 1 °C deviation from calibration temperature

Description	Specification (dB)		
	45 MHz to 2 GHz	2 to 20 GHz	20 to 26.5 GHz
Directivity	42	36	30
Source Match	37	28	25
Load Match	42	36	30
Reflection Tracking	±0.003 +0.02/°C	±0.008 +0.02/°C	±0.011 +0.03/°C
Transmission Tracking	±0.056 +0.02/°C	±0.169 +0.02/°C	±0.281 +0.03/°C

## Transmission Uncertainty (Specifications)

### Magnitude

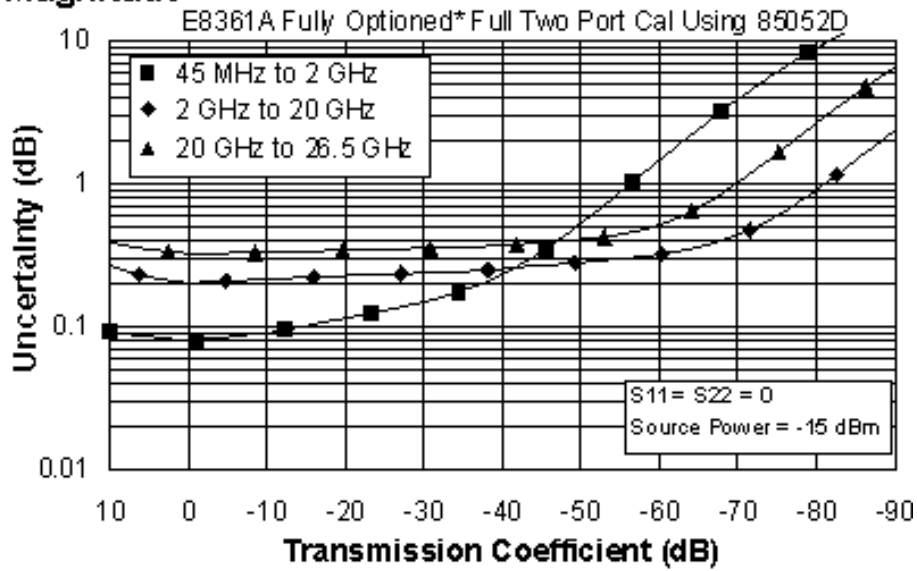

### Phase

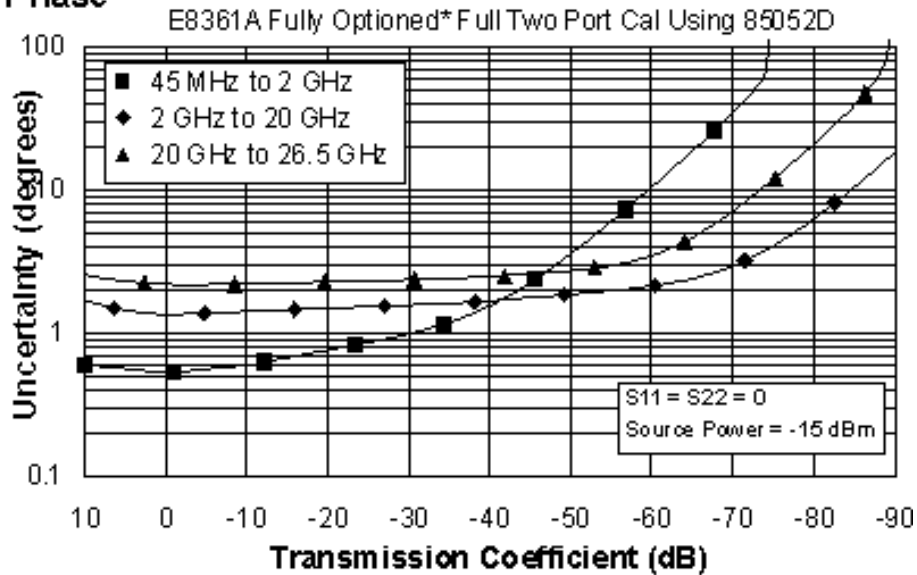

\* Configurable Test Set, and Frequency Offset Mode  
(E8361A - Option 014, and 080)

**Reflection Uncertainty (Specifications)**

**Magnitude**

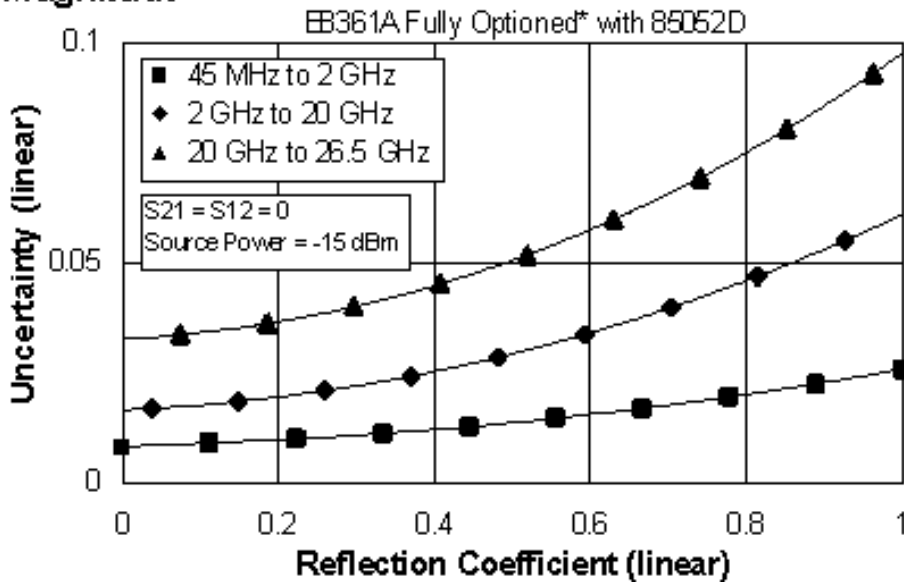

**Phase**

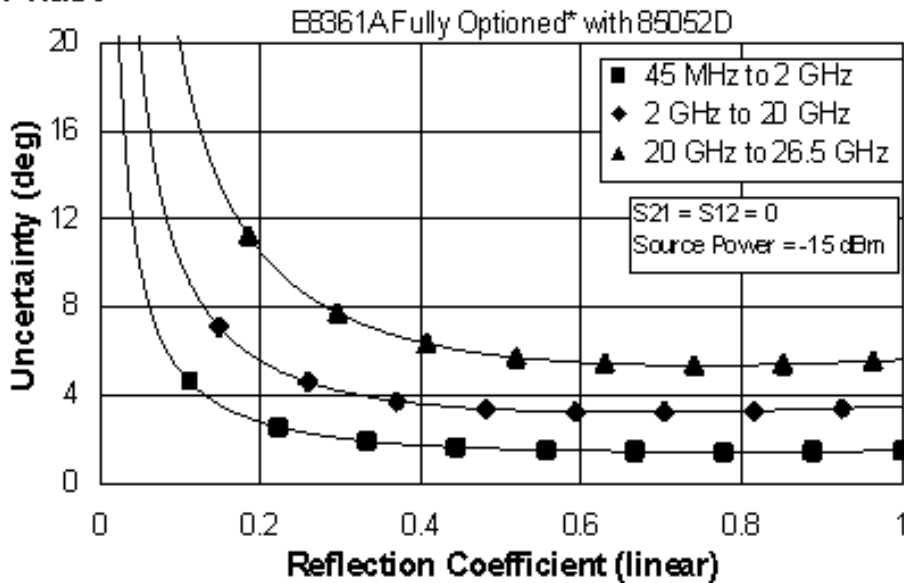

\* Configurable Test Set, and Frequency Offset Mode (E8361A - Option 014, and 080)

## E8361A Corrected System Performance with 7mm Connectors

**Table 14.** 85050B Calibration Kit

E8361A - Standard Configuration and Standard Power Range

Applies to the, E8361A analyzers, 85050B (7mm) calibration kit, 85132F flexible test port cable set, and a full 2-port calibration. Also applies to the following condition:

Environmental temperature 23° ±3 °C, with < 1 °C deviation from calibration temperature

Description	Specification (dB)	
	0.045 to 2 GHz	2 to 18 GHz
Directivity	52	52
Source Match	48	41
Load Match	52	47
Reflection Tracking	±0.003 +0.02/°C	±0.047 +0.02/°C
Transmission Tracking	±0.015 +0.02/°C	±0.039 +0.02/°C

## Transmission Uncertainty (Specifications)

### Magnitude

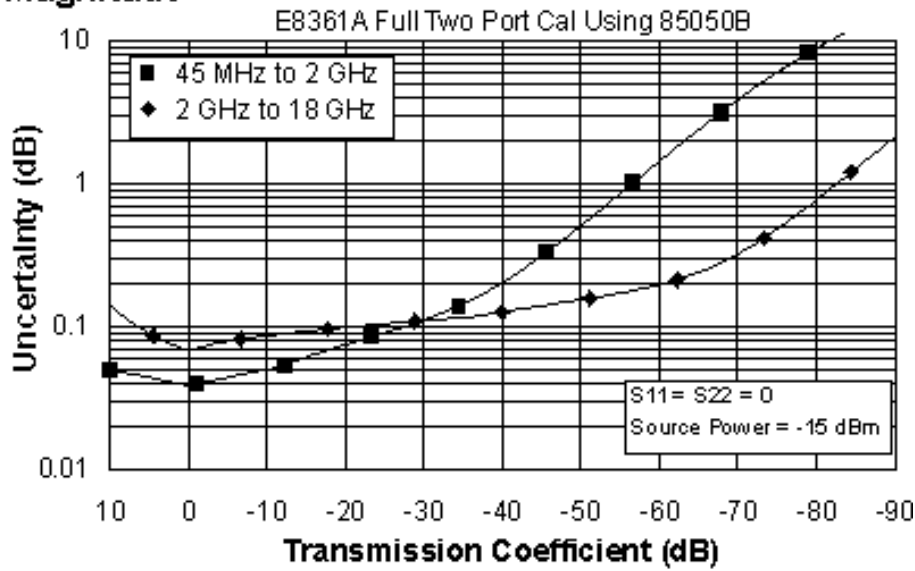

### Phase

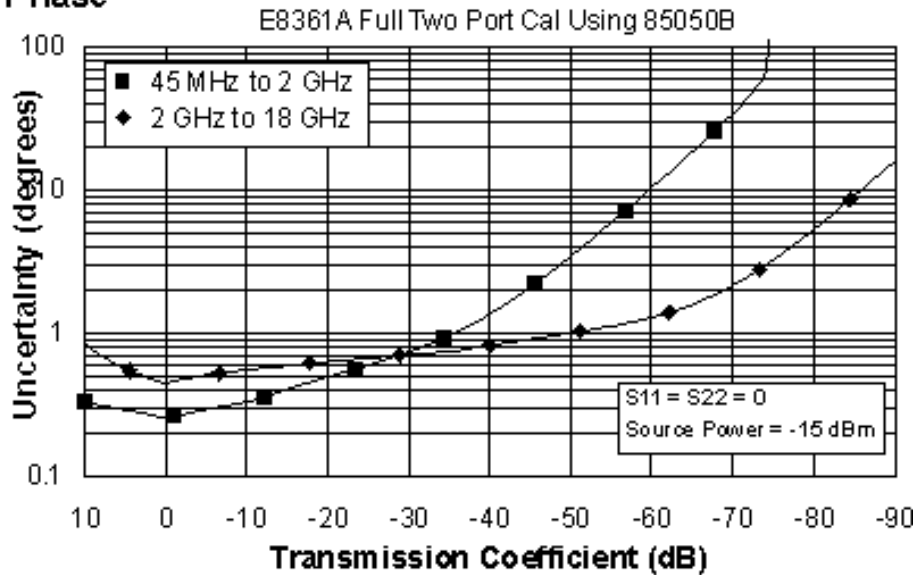

## Reflection Uncertainty (Specifications)

### Magnitude

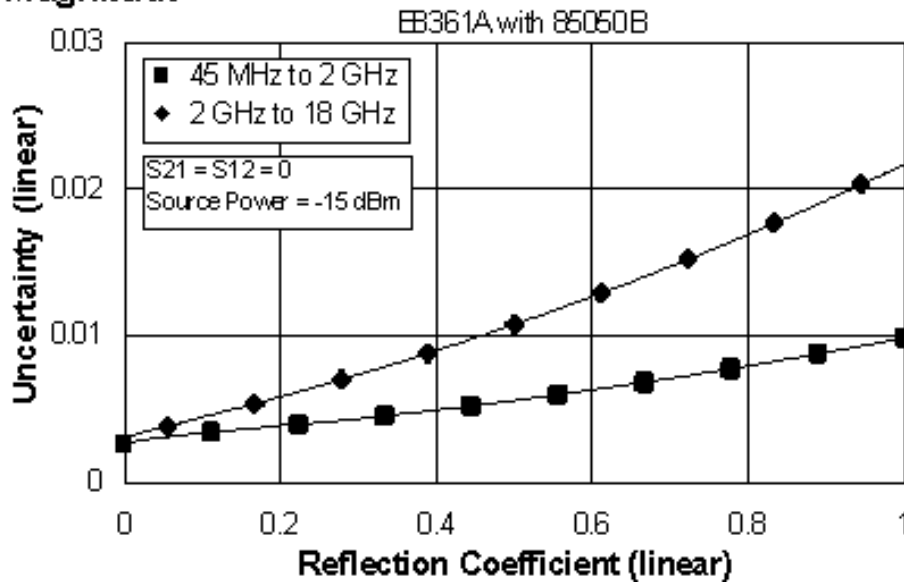

### Phase

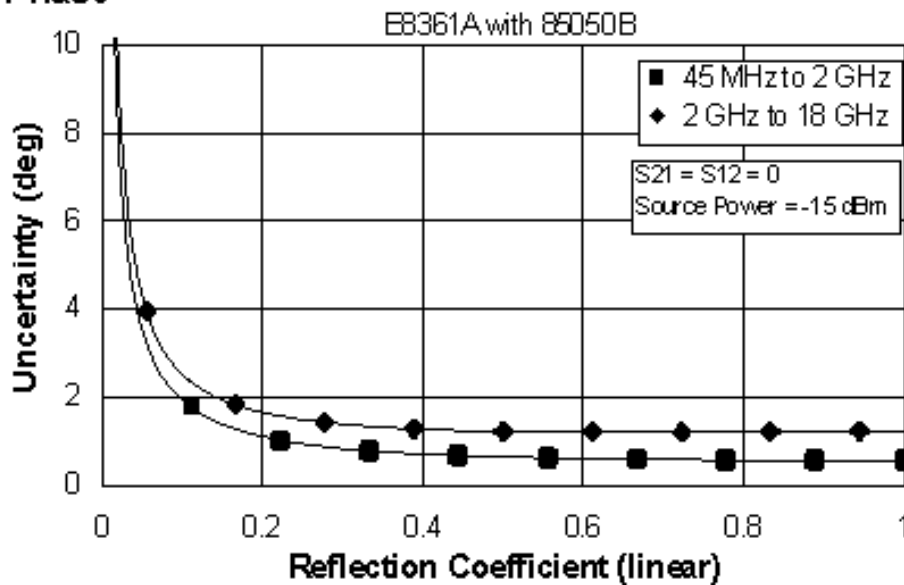

**Table 15. 85050B Calibration Kit**  
 E8361A - Fully Optioned (Option 014, and 080)  
 Configurable Test Set, and Frequency Offset Mode

Applies to the, E8361A analyzers, 85050B (7mm) calibration kit, 85132F flexible test port cable set, and a full 2-port calibration. Also applies to the following condition:

Environmental temperature 23° ±3 °C, with < 1 °C deviation from calibration temperature

Description	Specification (dB)	
	0.045 to 2 GHz	2 to 18 GHz
Directivity	52	52
Source Match	48	41
Load Match	52	47
Reflection Tracking	±0.003 +0.02/°C	±0.047 +0.02/°C
Transmission Tracking	±0.016 +0.02/°C	±0.042 +0.02/°C



## Transmission Uncertainty (Specifications)

### Magnitude

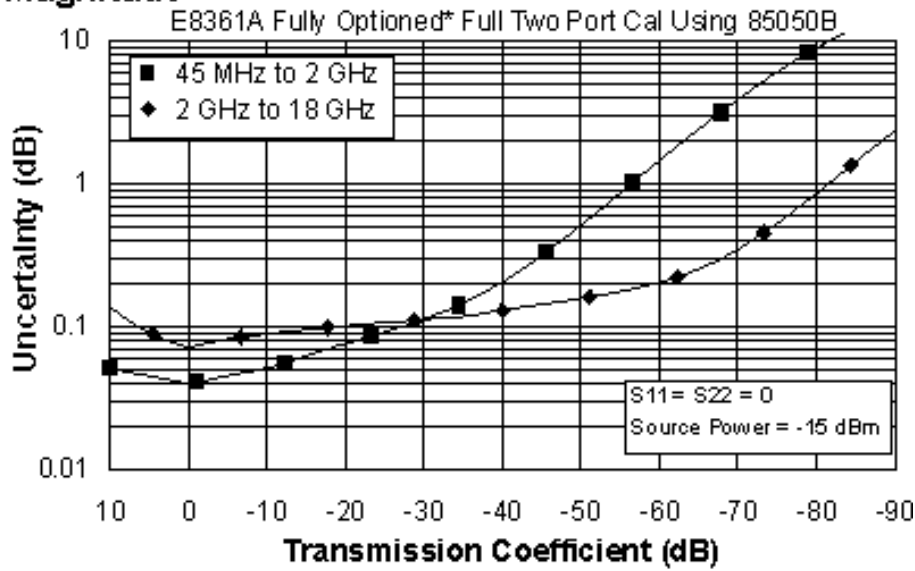

### Phase

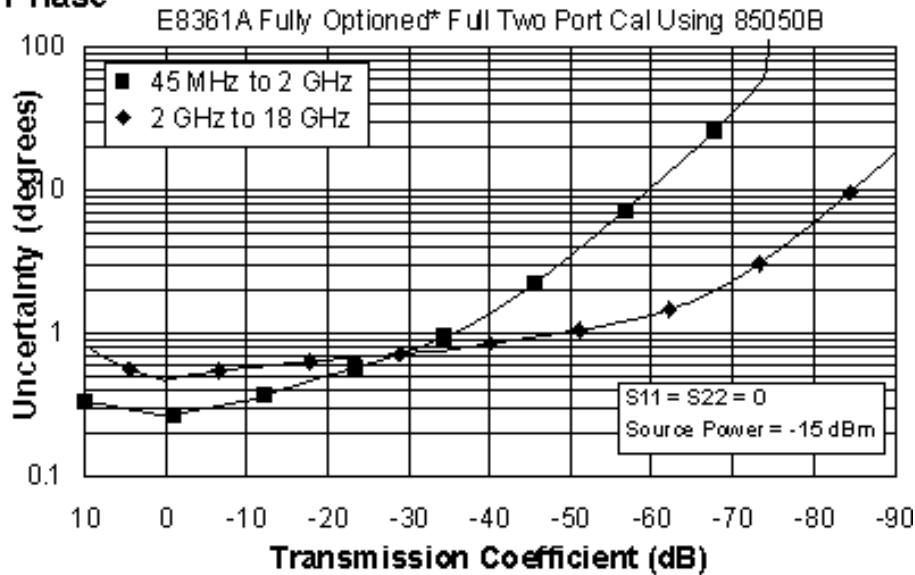

\*Configurable Test Set, and Frequency Offset Mode (E8361A - Option 014, and 080)

Reflection Uncertainty (Specifications)

Magnitude

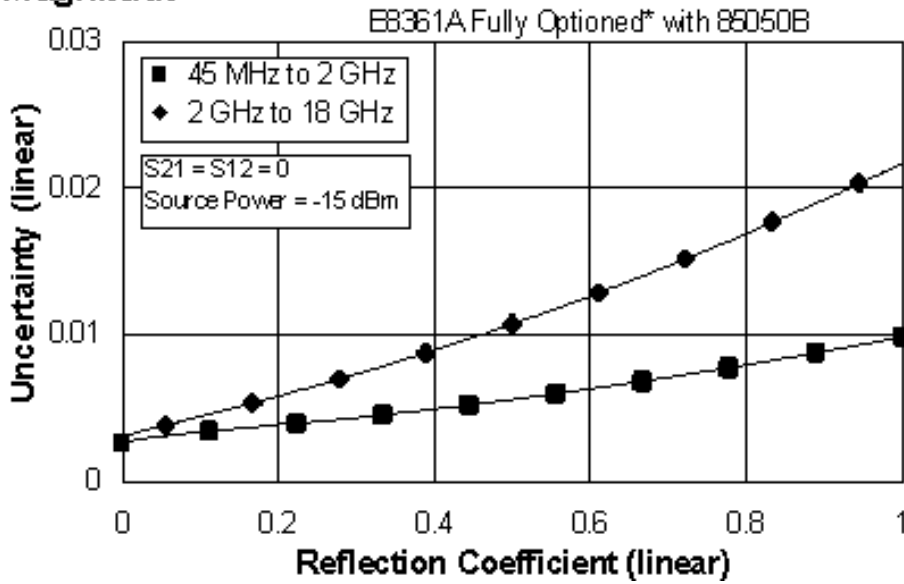

Phase

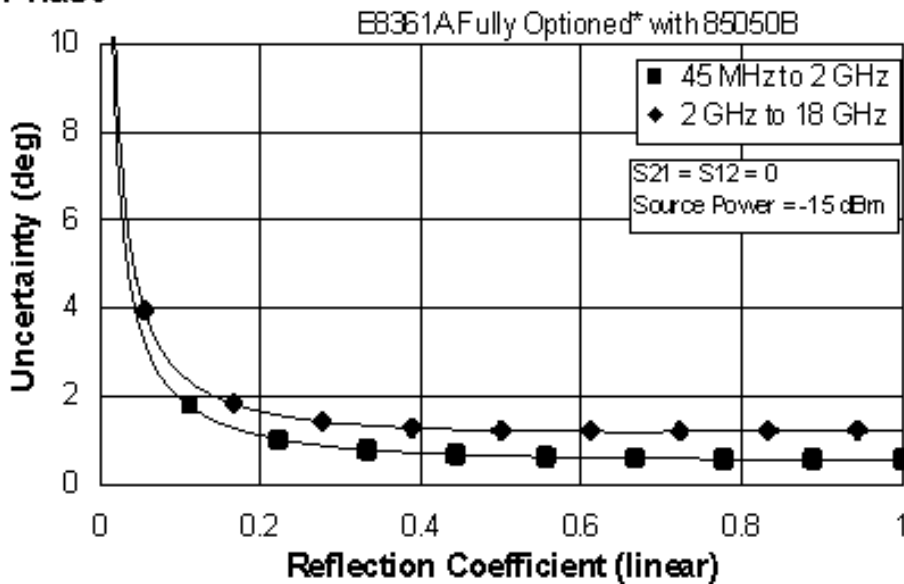

\*Configurable Test Set, and Frequency Offset Mode (E8361A - Option 014, and 080)

**Table 16. 85050C Calibration Kit**  
**E8361A - Standard Configuration and Standard Power Range**

Applies to the, E8361A analyzers, 85050C (7mm) calibration kit, 85132F flexible test port cable set, and a full 2-port calibration. Also applies to the following condition:

Environmental temperature 23° ±3 °C, with < 1 °C deviation from calibration temperature

Description	Specification (dB)	
	0.045 to 2 GHz	2 to 18 GHz
Directivity	52	60
Source Match	48	60
Load Match	52	60
Reflection Tracking	±0.003 +0.02/°C	±0.000 +0.02/°C
Transmission Tracking	±0.015 +0.02/°C	±0.005 +0.02/°C

## Transmission Uncertainty (Specifications)

### Magnitude

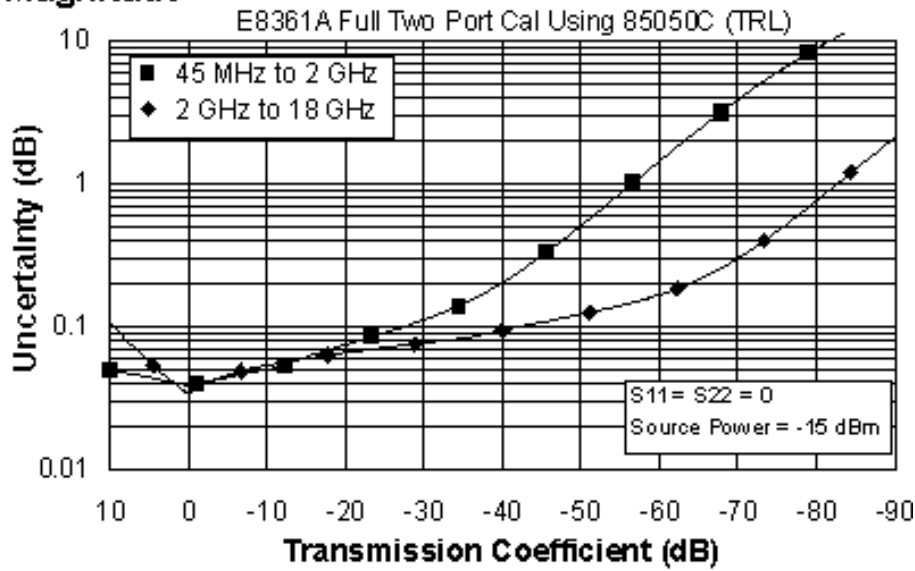

### Phase

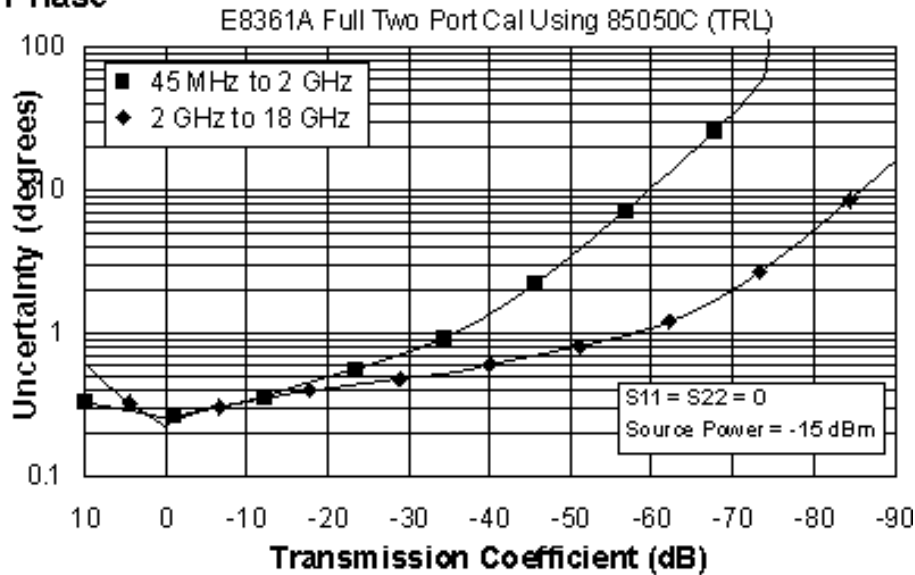

Reflection Uncertainty (Specifications)

Magnitude

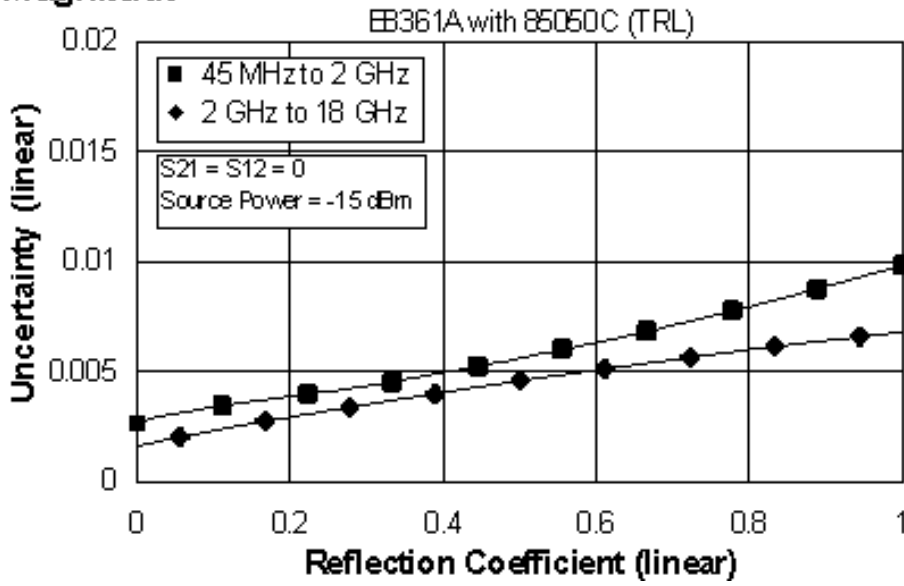

Phase

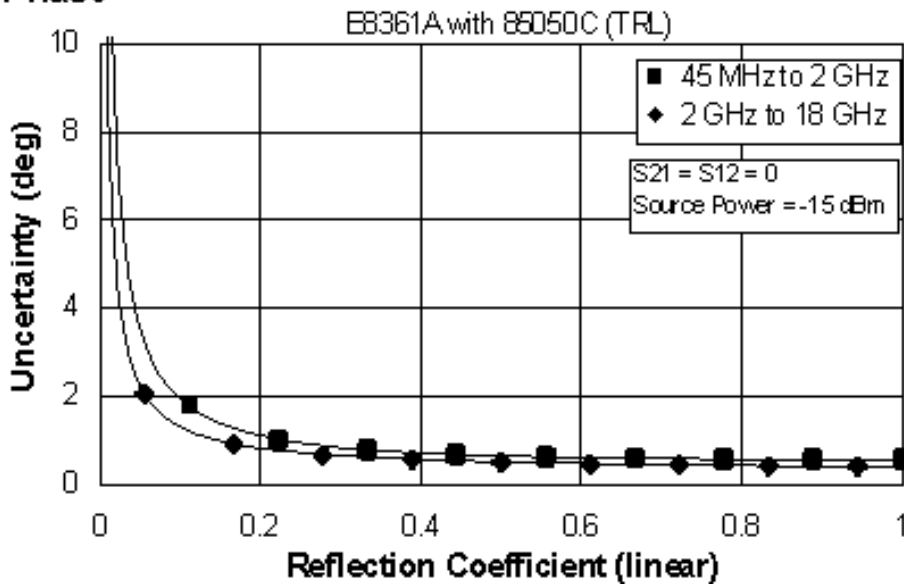

**Table 17. 85050C Calibration Kit**  
 E8361A - Fully Optioned (Option 014, and 080)  
 Configurable Test Set, and Frequency Offset Mode

Applies to the, E8361A analyzers, 85050C (7mm) calibration kit, 85132F flexible test port cable set, and a full 2-port calibration. Also applies to the following condition:

Environmental temperature  $23^{\circ} \pm 3^{\circ} \text{C}$ , with  $< 1^{\circ} \text{C}$  deviation from calibration temperature

Description	Specification (dB)	
	0.045 to 2 GHz	2 to 18 GHz
Directivity	52	60
Source Match	48	60
Load Match	52	60
Reflection Tracking	$\pm 0.003$ $+0.02/^{\circ}\text{C}$	$\pm 0.000$ $+0.02/^{\circ}\text{C}$
Transmission Tracking	$\pm 0.016$ $+0.02/^{\circ}\text{C}$	$\pm 0.006$ $+0.02/^{\circ}\text{C}$

## Transmission Uncertainty (Specifications)

### Magnitude

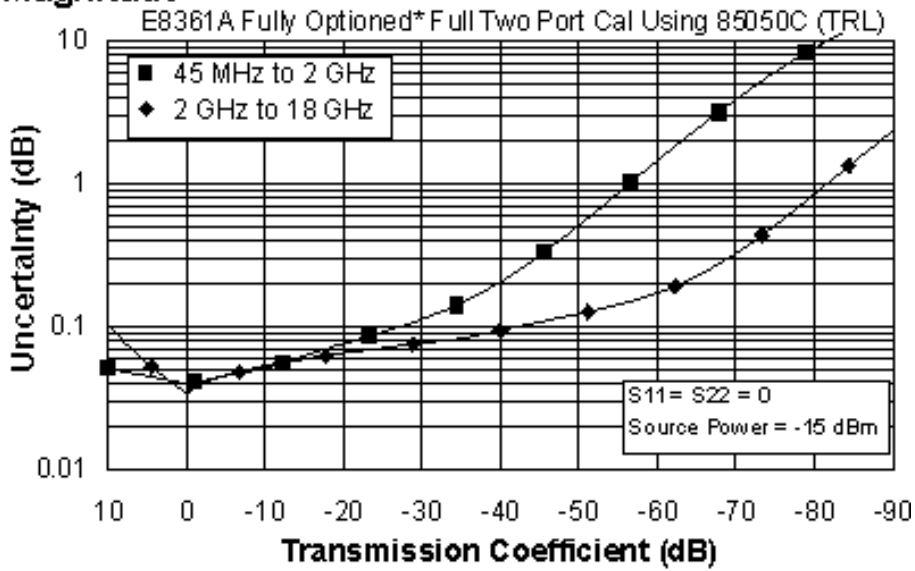

### Phase

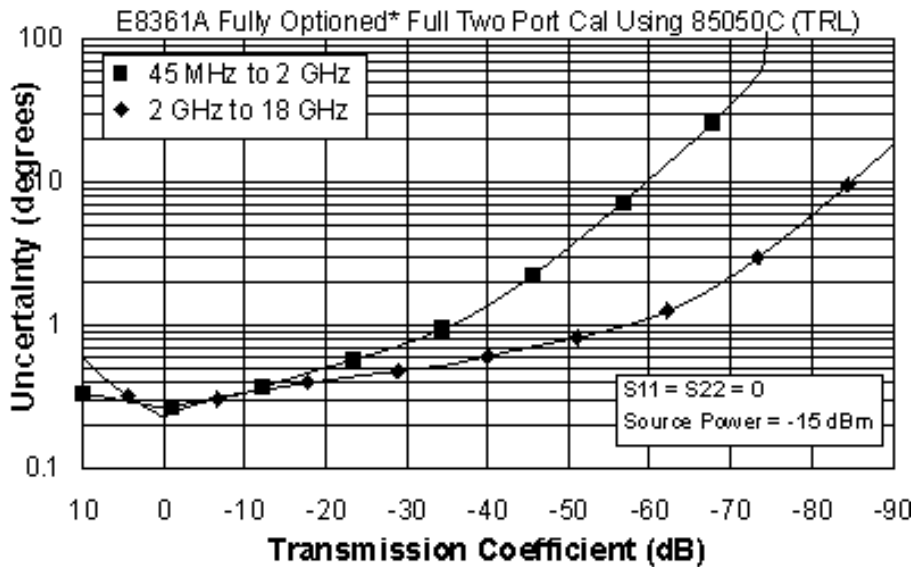

\*Configurable Test Set, and Frequency Offset Mode(E8361A - Option 014, and 080)

## Reflection Uncertainty (Specifications)

### Magnitude

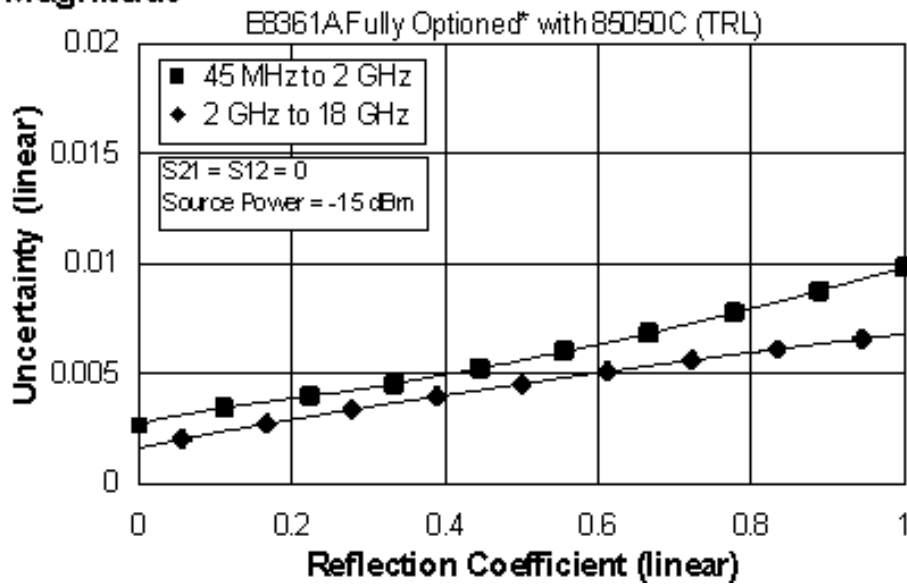

### Phase

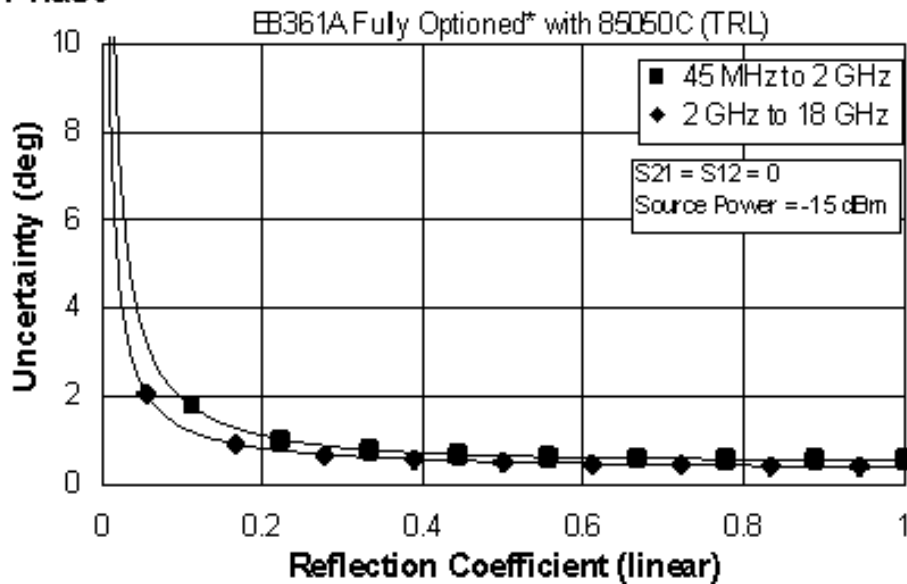

\*Configurable Test Set, and Frequency Offset Mode (E8361A - Option 014, and 080)



**Table 18. 85050D Calibration Kit  
E8361A - Standard Configuration and Standard Power Range**

Applies to the, E8361A analyzers, 85050D (7mm) calibration kit, 85132F flexible test port cable set, and a full 2-port calibration. Also applies to the following condition:

Environmental temperature 23° ±3 °C, with < 1 °C deviation from calibration temperature

Description	Specification (dB)	
	0.045 to 2 GHz	2 to 18 GHz
Directivity	40	40
Source Match	39	35
Load Match	40	37
Reflection Tracking	±0.010 +0.02/°C	±0.100 +0.02/°C
Transmission Tracking	±0.046 +0.02/°C	±0.089 +0.02/°C

## Transmission Uncertainty (Specifications)

### Magnitude

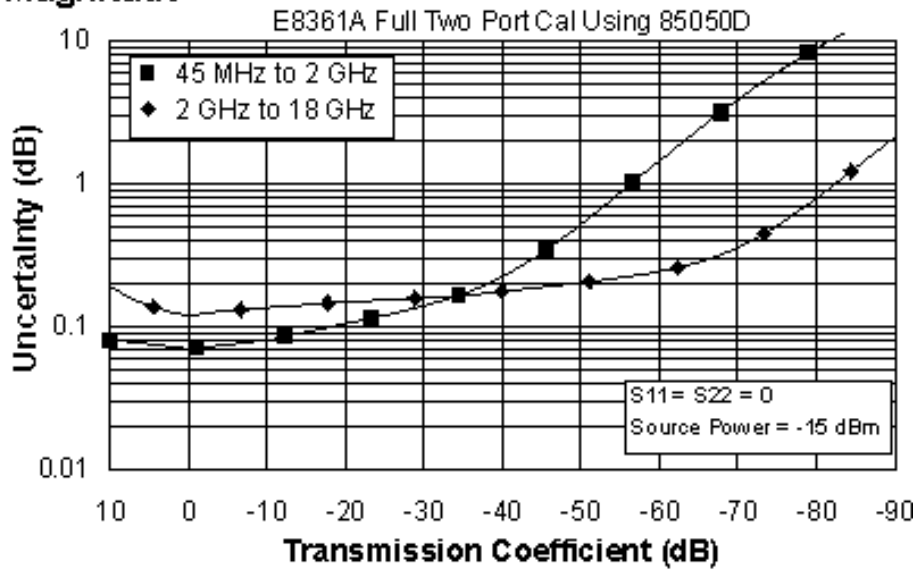

### Phase

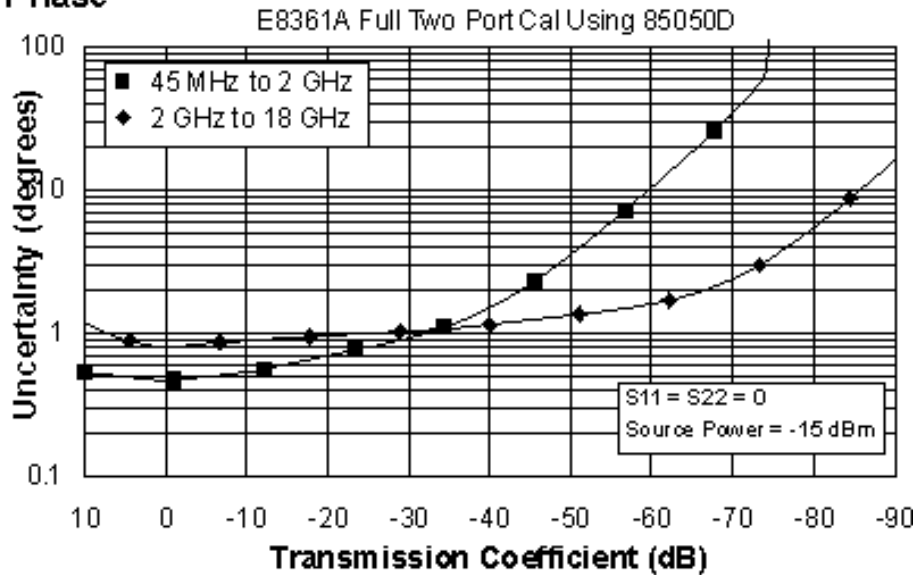

## Reflection Uncertainty (Specifications)

### Magnitude

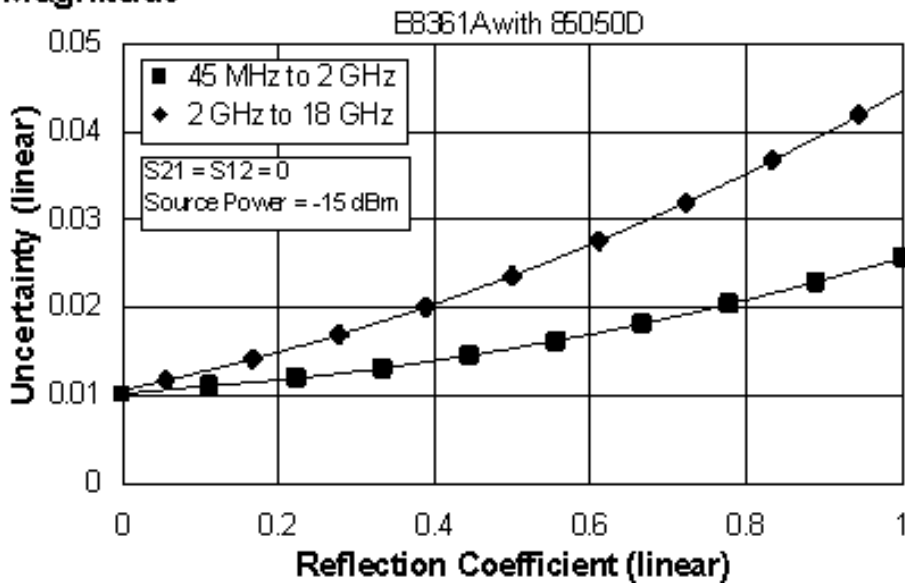

### Phase

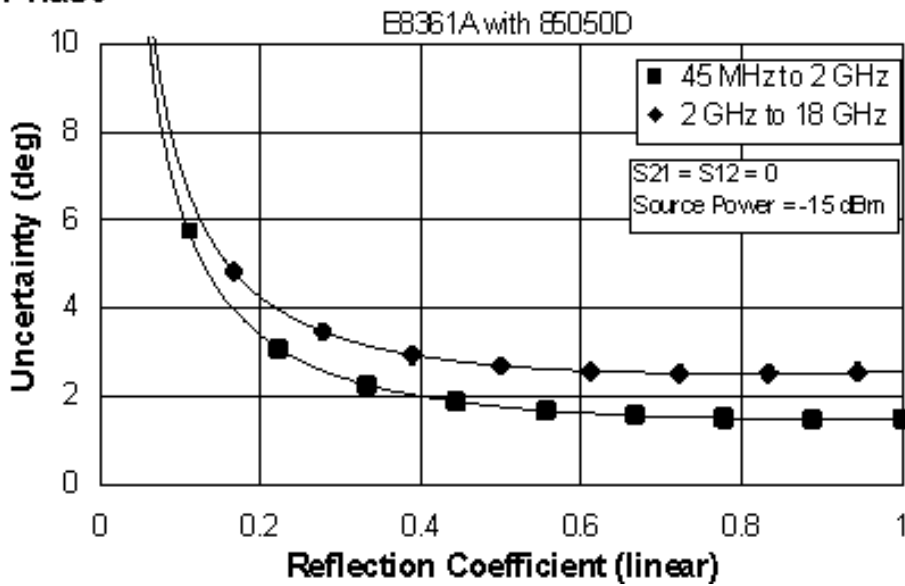

**Table 19. 85050D Calibration Kit**  
 E8361A - Fully Optioned (Option 014, and 080)  
 Configurable Test Set, and Frequency Offset Mode

Applies to the, E8361A analyzers, 85050D (7mm) calibration kit, 85132F flexible test port cable set, and a full 2-port calibration. Also applies to the following condition:

Environmental temperature 23° ±3 °C, with < 1 °C deviation from calibration temperature

Description	Specification (dB)	
	0.045 to 2 GHz	2 to 18 GHz
Directivity	40	40
Source Match	39	35
Load Match	40	37
Reflection Tracking	±0.010 +0.02/°C	±0.100 +0.02/°C
Transmission Tracking	±0.049 +0.02/°C	±0.097 +0.02/°C

## Transmission Uncertainty (Specifications)

### Magnitude

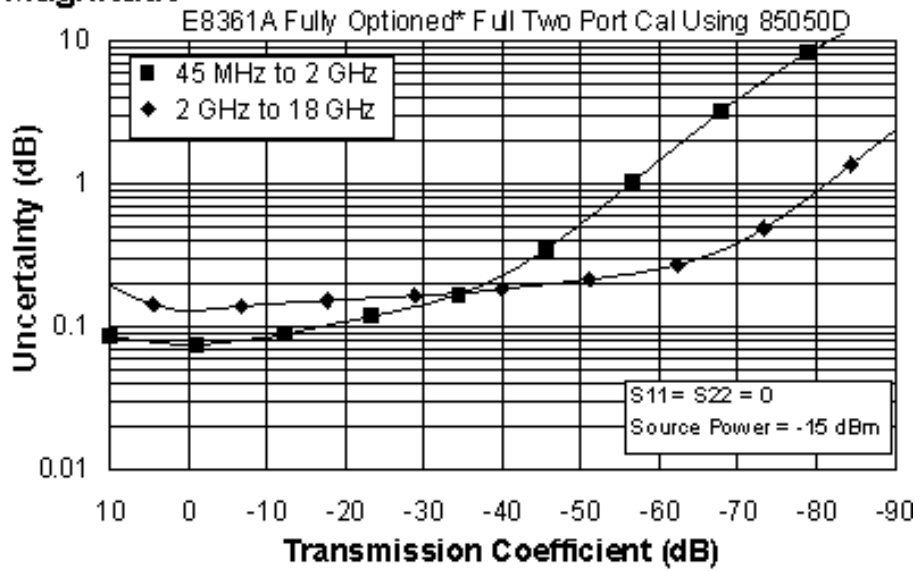

### Phase

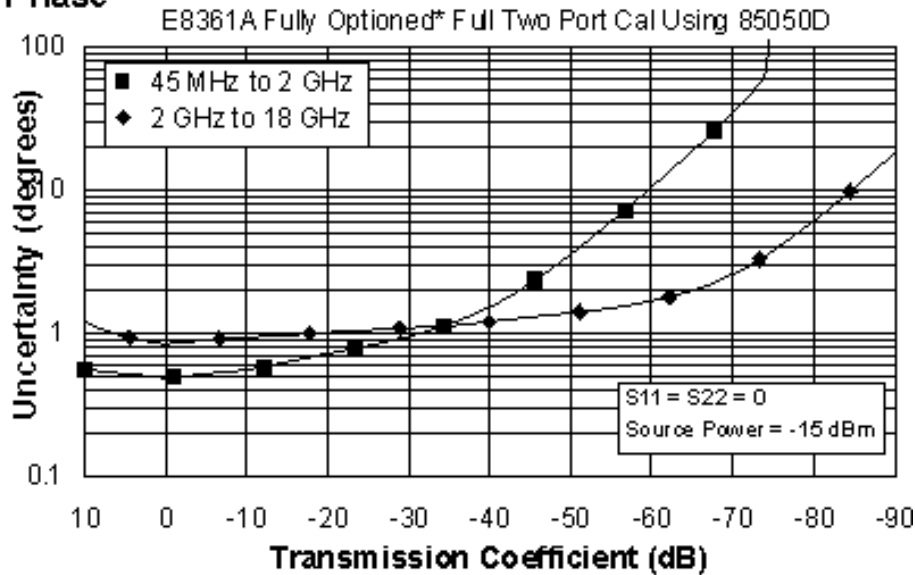

\*Configurable Test Set, and Frequency Offset Mode(E8361A - Option 014, and 080)

## Reflection Uncertainty (Specifications)

### Magnitude

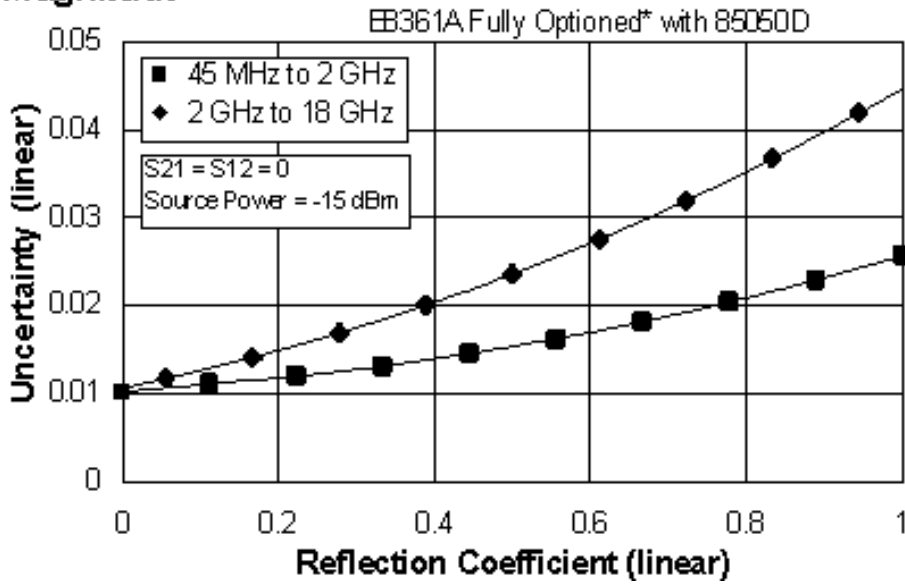

### Phase

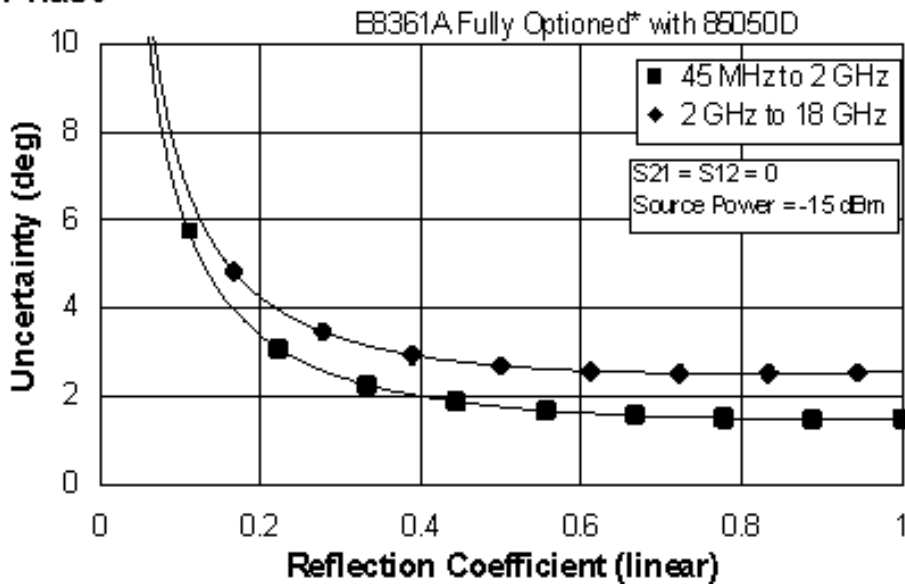

\*Configurable Test Set, and Frequency Offset Mode (E8361A - Option 014, and 080)

## E8361A Corrected System Performance with Type-N Connectors

**Table 20.** 85054B Calibration Kit

E8361A - Standard Configuration and Standard Power Range

Applies to the, E8361A analyzers, 85054B (Type-N) calibration kit, 85132F flexible test port cable set with 85130C adapter set, and a full 2-port calibration. Also applies to the following condition:

Environmental temperature  $23^{\circ} \pm 3^{\circ} \text{C}$ , with  $< 1^{\circ} \text{C}$  deviation from calibration temperature

Description	Specification (dB)	
	0.045 to 2 GHz	2 to 18 GHz
Directivity	48	42
Source Match	45	33
Load Match	48	41
Reflection Tracking	$\pm 0.001$ $+0.02/^{\circ}\text{C}$	$\pm 0.015$ $+0.02/^{\circ}\text{C}$
Transmission Tracking	$\pm 0.022$ $+0.02/^{\circ}\text{C}$	$\pm 0.096$ $+0.02/^{\circ}\text{C}$

## Transmission Uncertainty (Specifications)

### Magnitude

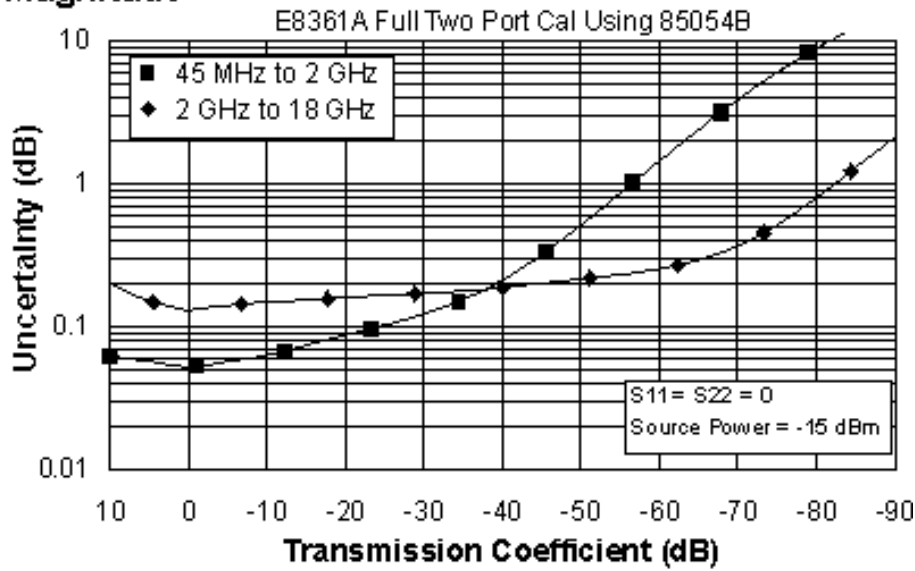

### Phase

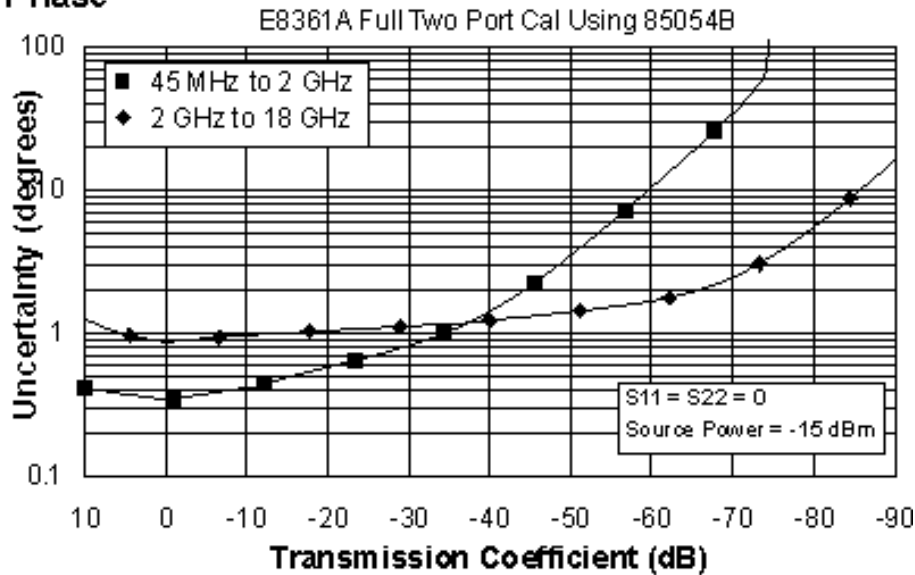



Reflection Uncertainty (Specifications)

Magnitude

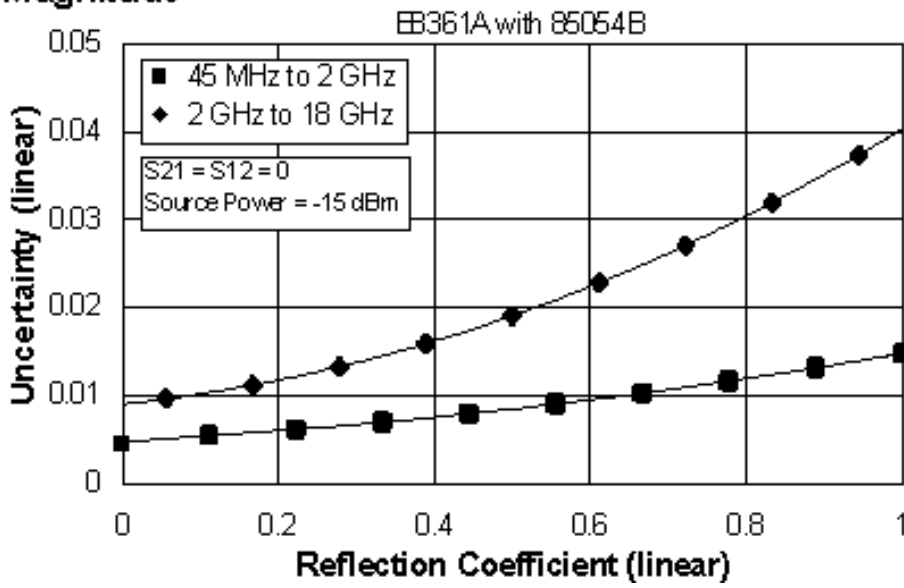

Phase

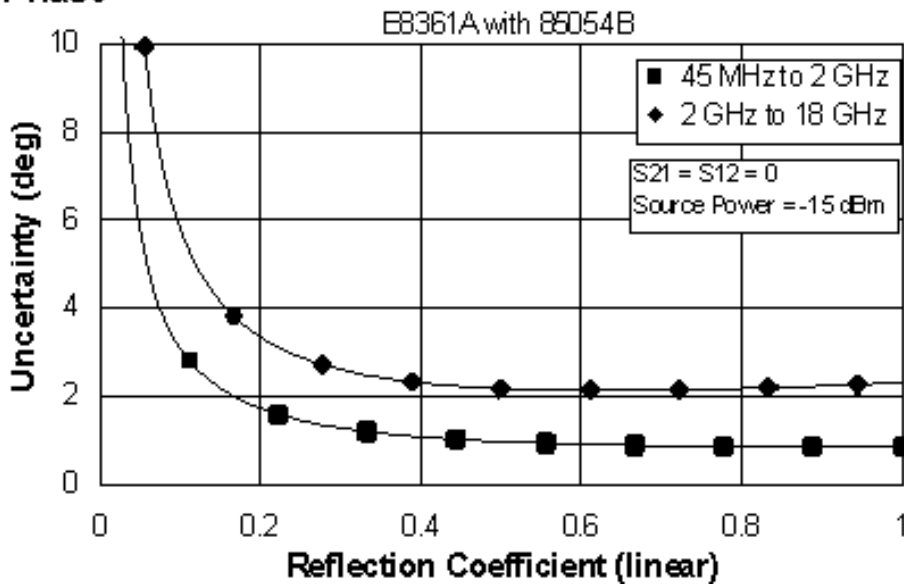

**Table 21. 85054B Calibration Kit**  
 E8361A - Fully Optioned (Option 014, and 080)  
 Configurable Test Set, and Frequency Offset Mode

Applies to the, E8361A analyzers, 85054B (Type-N) calibration kit, 85132F flexible test port cable set with 85130C adapter set, and a full 2-port calibration. Also applies to the following condition:

Environmental temperature 23° ±3 °C, with < 1 °C deviation from calibration temperature

Description	Specification (dB)	
	0.045 to 2 GHz	2 to 18 GHz
Directivity	48	42
Source Match	45	33
Load Match	48	41
Reflection Tracking	±0.001 +0.02/°C	±0.015 +0.02/°C
Transmission Tracking	±0.024 +0.02/°C	±0.102 +0.02/°C

## Transmission Uncertainty (Specifications)

### Magnitude

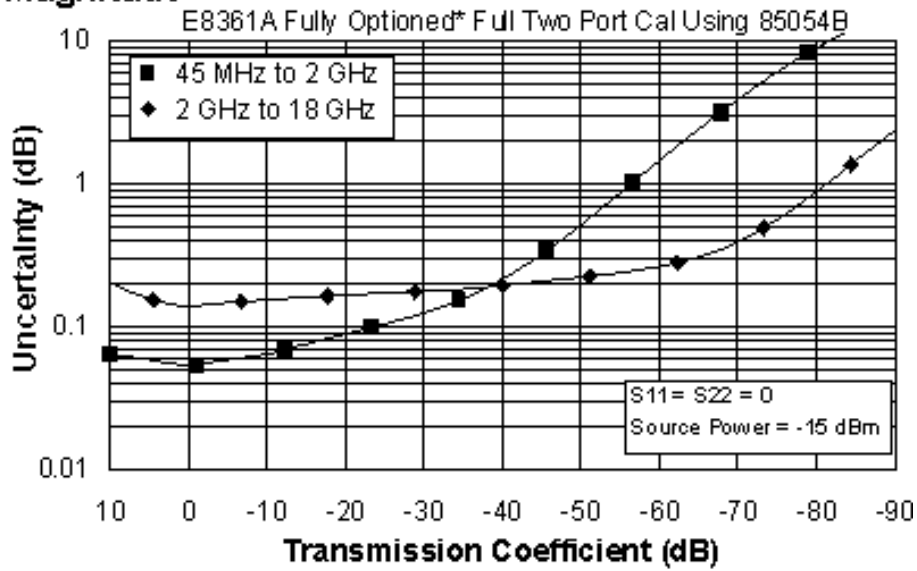

### Phase

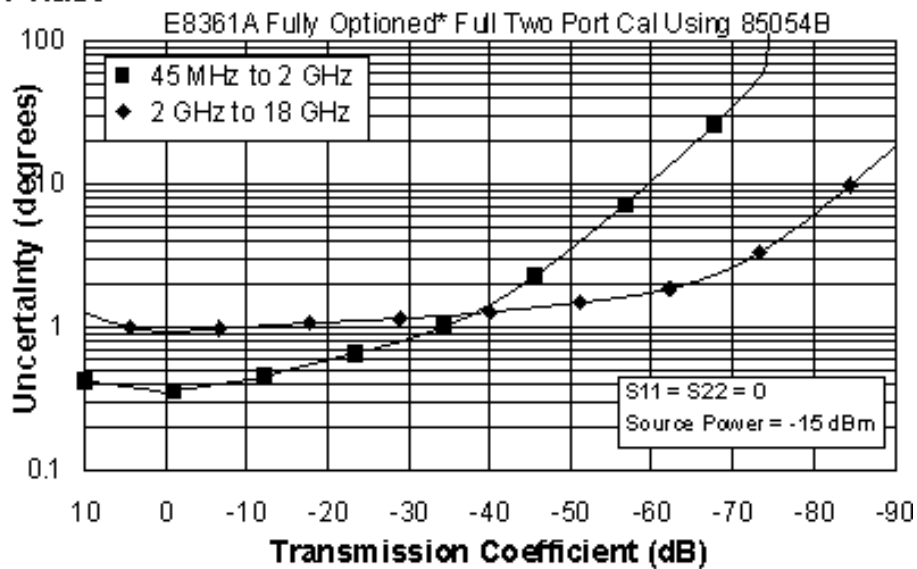

\* Configurable Test Set, and Frequency Offset Mode (E8361A - Option 014, and 080)

## Reflection Uncertainty (Specifications)

### Magnitude

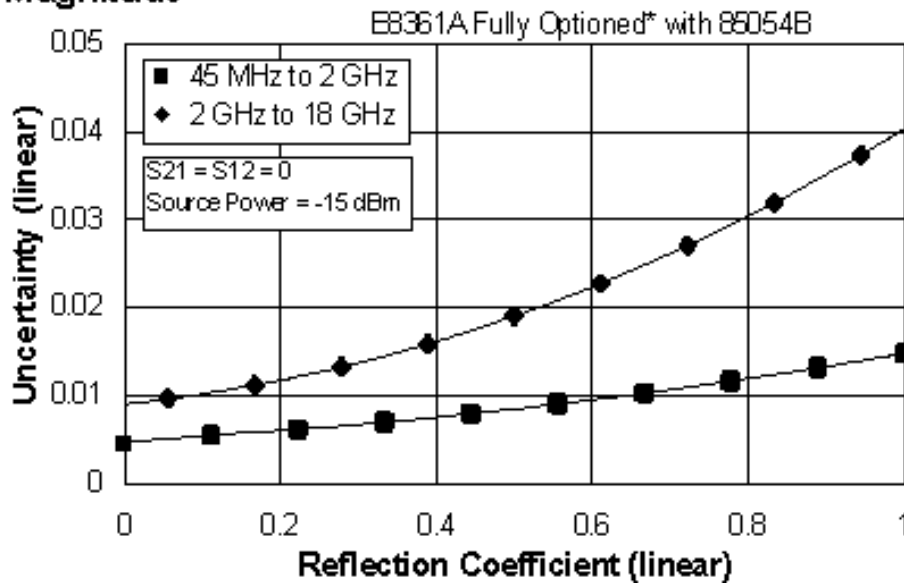

### Phase

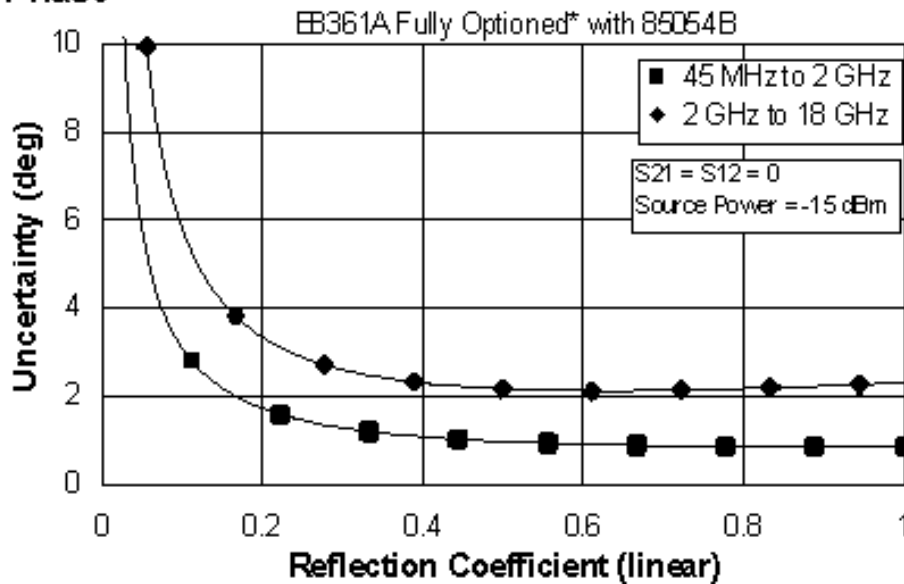

\* Configurable Test Set, and Frequency Offset Mode  
(E8361A - Option 014, and 080)

**Table 22. 85054D Calibration Kit  
E8361A - Standard Configuration and Standard Power Range**

Applies to the, E8361A analyzers, 85054D (Type-N) calibration kit, 85132F flexible test port cable set with 85130C adapter set, and a full 2-port calibration. Also applies to the following condition:

Environmental temperature 23° ±3 °C, with < 1 °C deviation from calibration temperature

Description	Specification (dB)	
	0.045 to 2 GHz	2 to 18 GHz
Directivity	40	34
Source Match	39	29
Load Match	40	34
Reflection Tracking	±0.003 +0.02/°C	±0.027 +0.02/°C
Transmission Tracking	±0.048 +0.02/°C	±0.164 +0.02/°C

## Transmission Uncertainty (Specifications)

### Magnitude

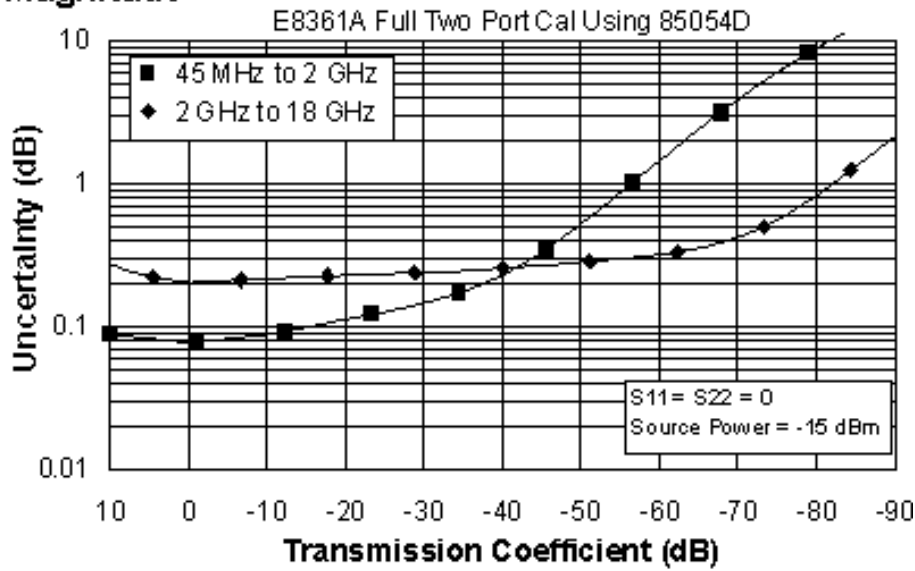

### Phase

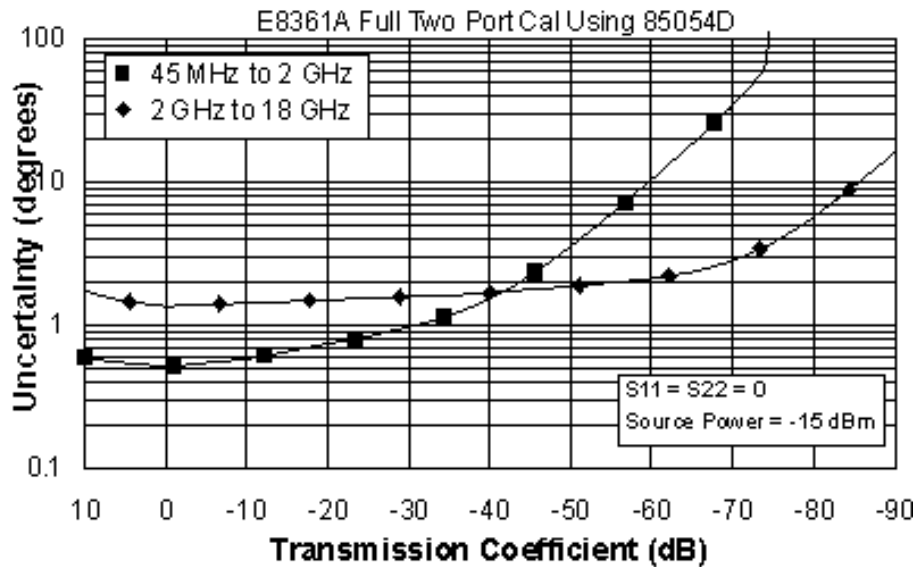

Reflection Uncertainty (Specifications)

Magnitude

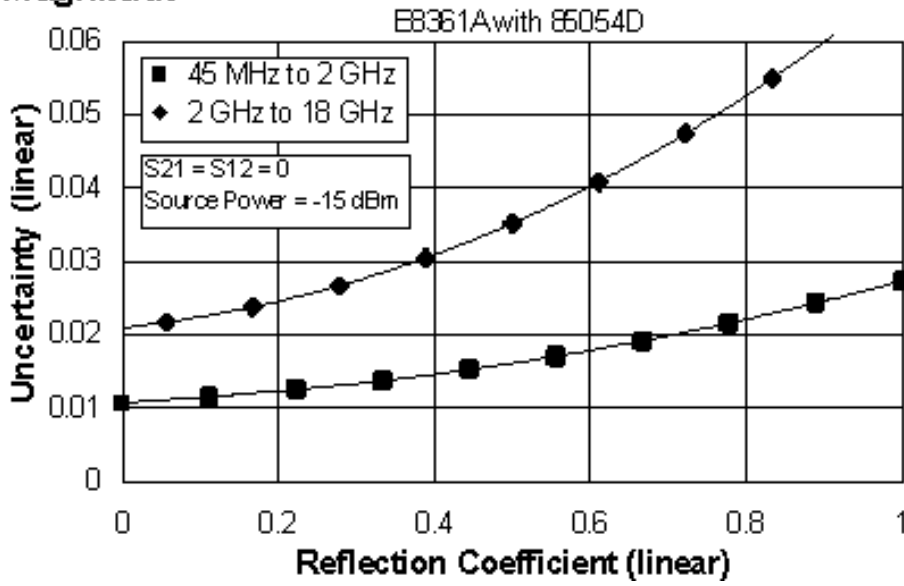

Phase

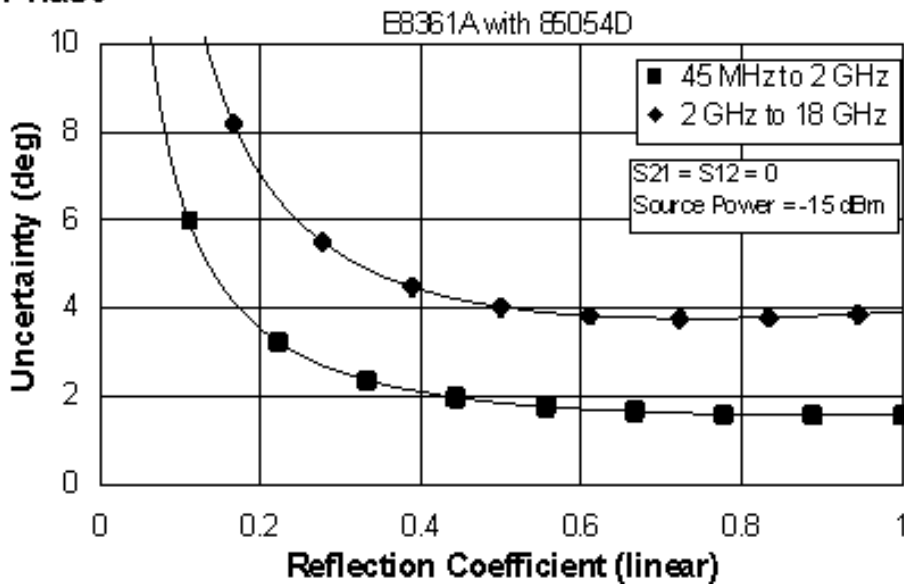

**Table 23. 85054D Calibration Kit**  
 E8361A - Fully Optioned (Option 014, and 080)  
 Configurable Test Set, and Frequency Offset Mode

Applies to the, E8361A analyzers, 85054D (Type-N) calibration kit, 85132F flexible test port cable set with 85130C adapter set, and a full 2-port calibration. Also applies to the following condition:

Environmental temperature  $23^{\circ} \pm 3^{\circ} \text{C}$ , with  $< 1^{\circ} \text{C}$  deviation from calibration temperature

Description	Specification (dB)	
	0.045 to 2 GHz	2 to 18 GHz
Directivity	40	34
Source Match	39	29
Load Match	40	33
Reflection Tracking	$\pm 0.003$ $+0.02/^{\circ}\text{C}$	$\pm 0.027$ $+0.02/^{\circ}\text{C}$
Transmission Tracking	$\pm 0.051$ $+0.02/^{\circ}\text{C}$	$\pm 0.177$ $+0.02/^{\circ}\text{C}$



## Transmission Uncertainty (Specifications)

### Magnitude

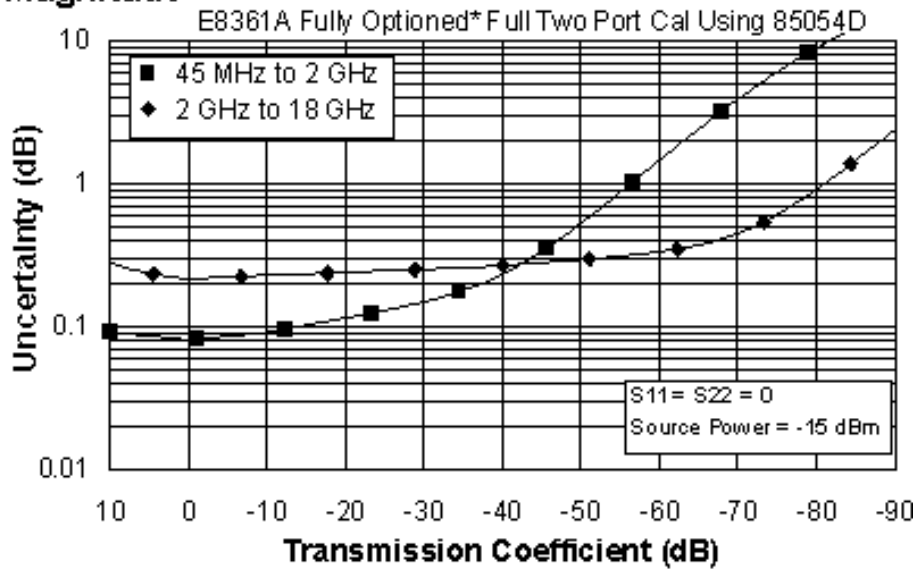

### Phase

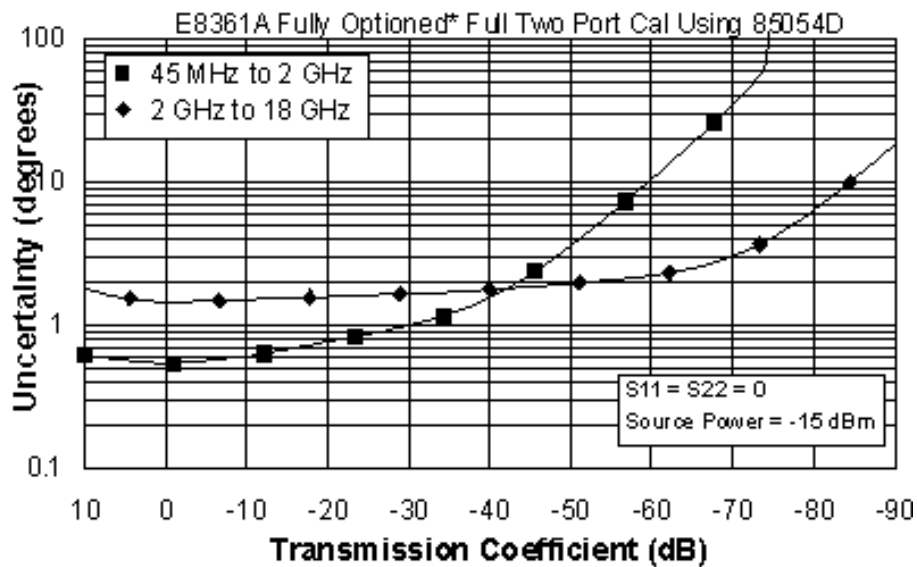

\* Configurable Test Set, and Frequency Offset Mode  
(E8361A - Option 014, and 080)

**Reflection Uncertainty (Specifications)**

**Magnitude**

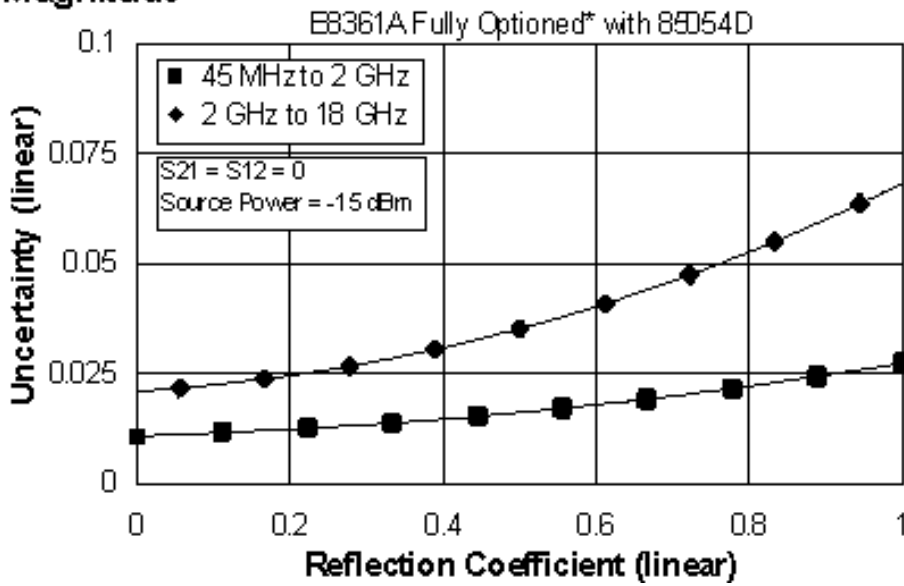

**Phase**

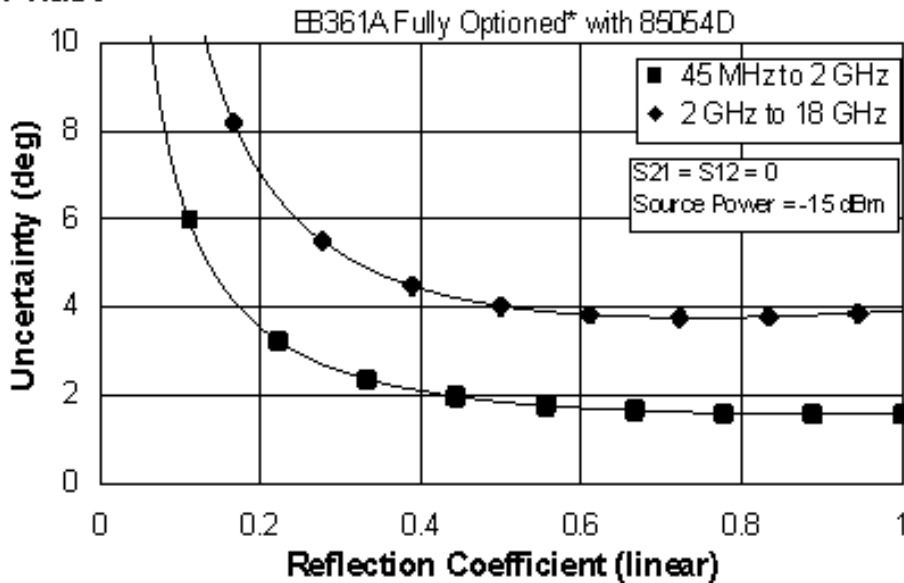

\* Configurable Test Set, and Frequency Offset Mode (E8361A - Option 014, and 080)

## E8361A Corrected System Performance with WR-28 Connectors

**Table 24.** R11644A Calibration Kit

### E8361A - Standard Configuration and Standard Power Range

Applies to the, E8361A analyzers, R11644A (WR-28) calibration kit, 85133F flexible test port cable set with the R281A and R281B launch sets, and a full 2-port calibration. Also applies to the following condition:

Environmental temperature  $23^{\circ} \pm 3^{\circ} \text{C}$ , with  $< 1^{\circ} \text{C}$  deviation from calibration temperature

<b>Description</b>	<b>Specification (dB)</b>
Directivity	50
Source Match	50
Load Match	50
Reflection Tracking	$\pm 0.000$ $+0.03/^{\circ}\text{C}$
Transmission Tracking	$\pm 0.025$ $+0.03/^{\circ}\text{C}$

## Transmission Uncertainty (Specifications)

### Magnitude

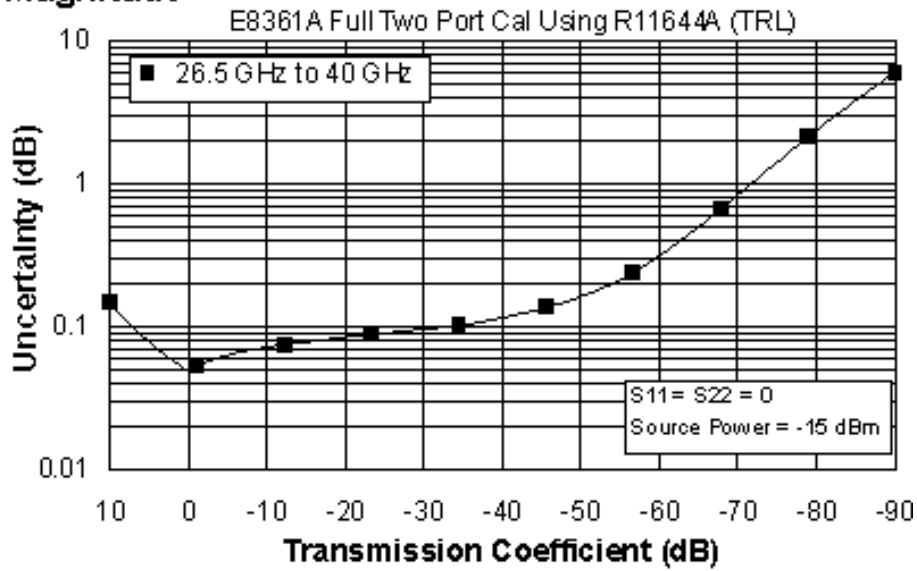

### Phase

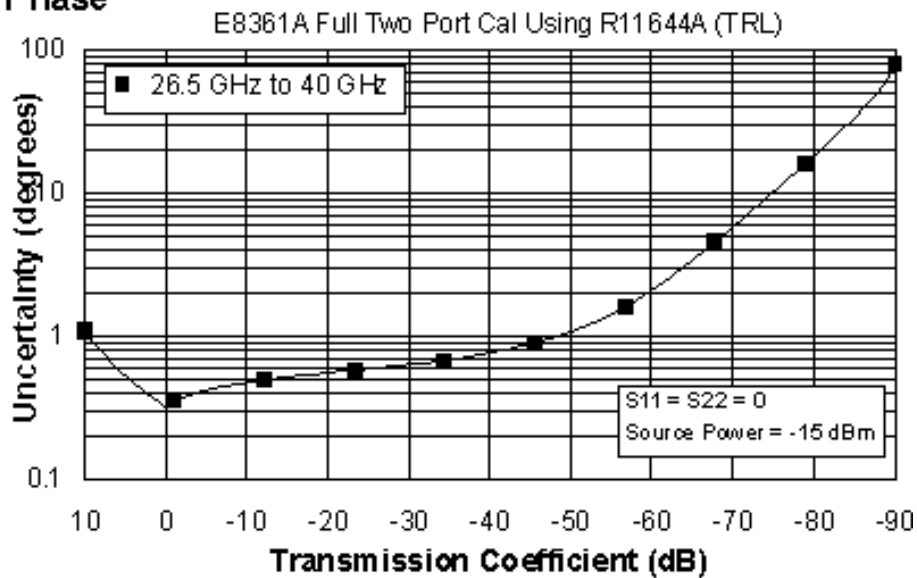

## Reflection Uncertainty (Specifications)

### Magnitude

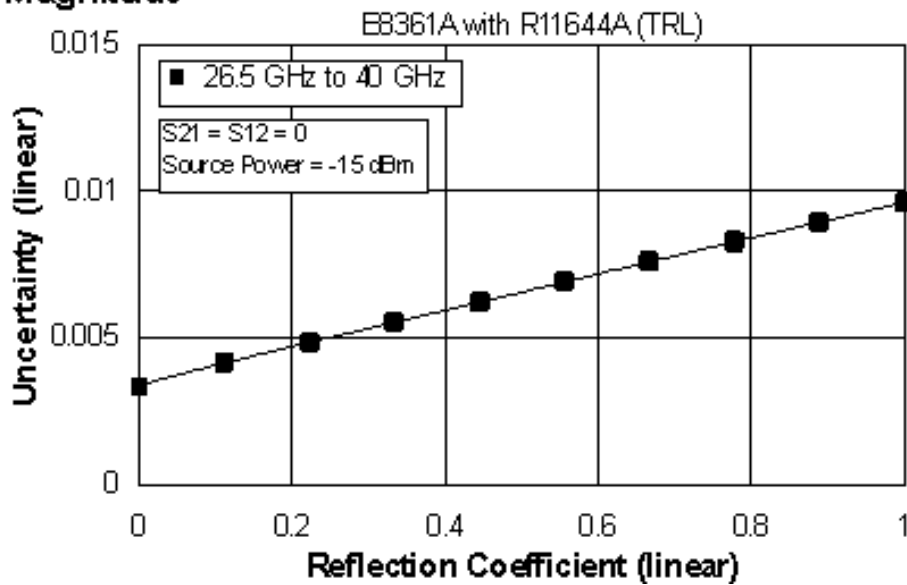

### Phase

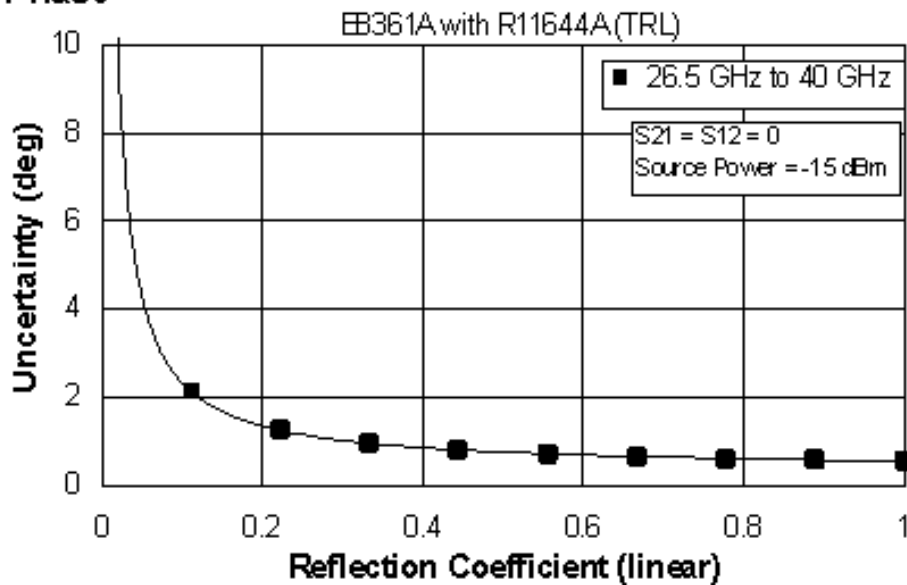

**Table 25. R11644A Calibration Kit**  
 E8361A - Fully Optioned (Option 014, and 080)  
 Configurable Test Set, and Frequency Offset Mode

Applies to the, E8361A analyzers, R11644A (WR-28) calibration kit, 85133F flexible test port cable set with the R281A and R281B launch sets, and a full 2-port calibration. Also applies to the following condition:

Environmental temperature 23° ±3 °C, with < 1 °C deviation from calibration temperature

Description	Specification (dB)
	26.5 to 40 GHz
Directivity	50
Source Match	50
Load Match	50
Reflection Tracking	±0.000 +0.03/°C
Transmission Tracking	±0.023 +0.03/°C

## Transmission Uncertainty (Specifications)

### Magnitude

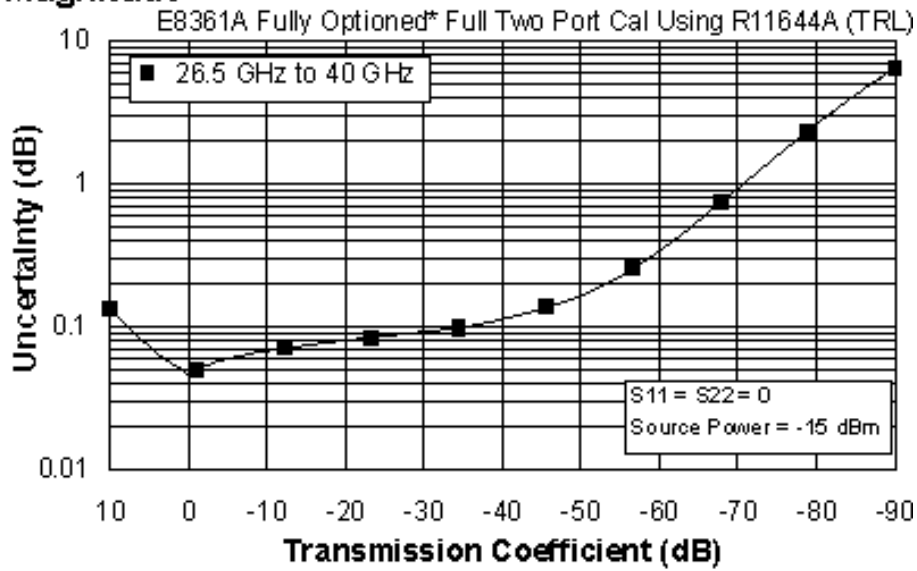

### Phase

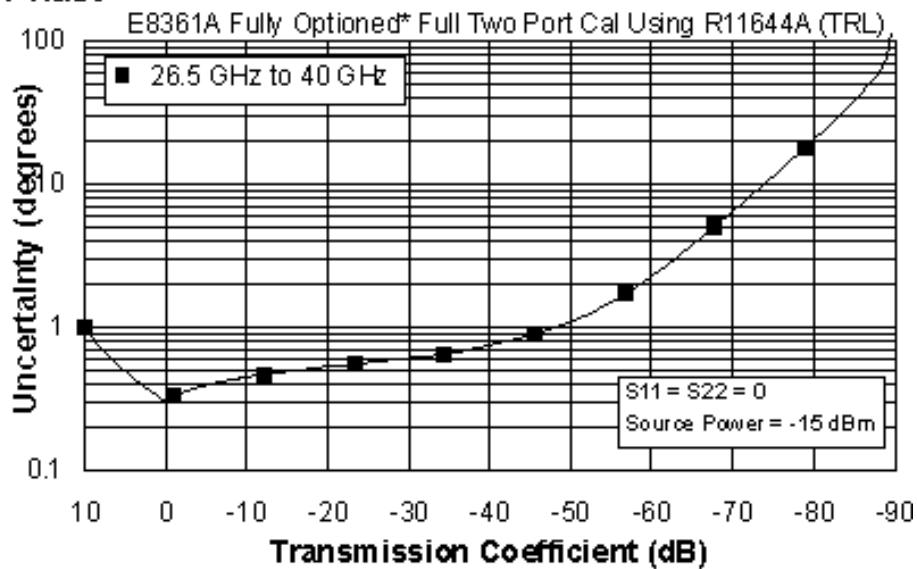

\* Configurable Test Set, and Frequency Offset Mode (E8361A - Option 014, and 080)

## Reflection Uncertainty (Specifications)

### Magnitude

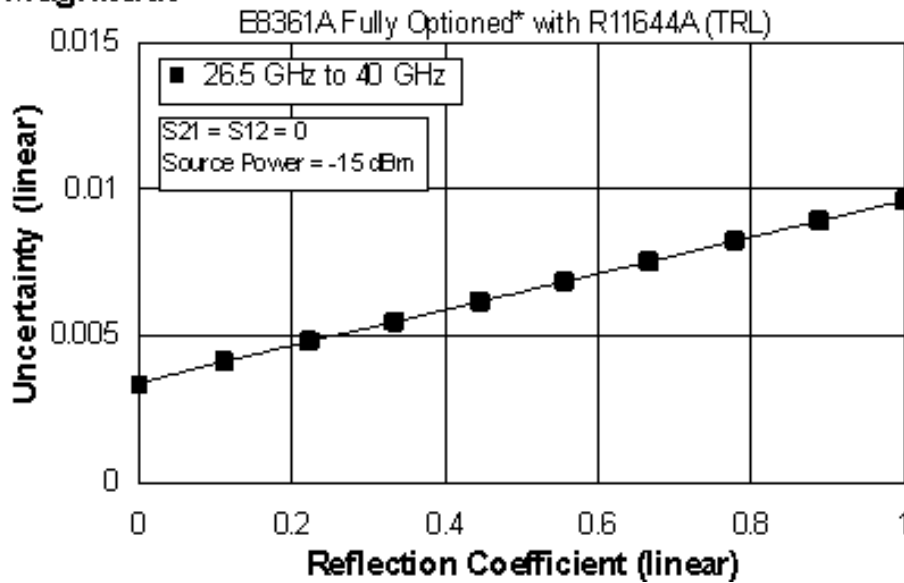

### Phase

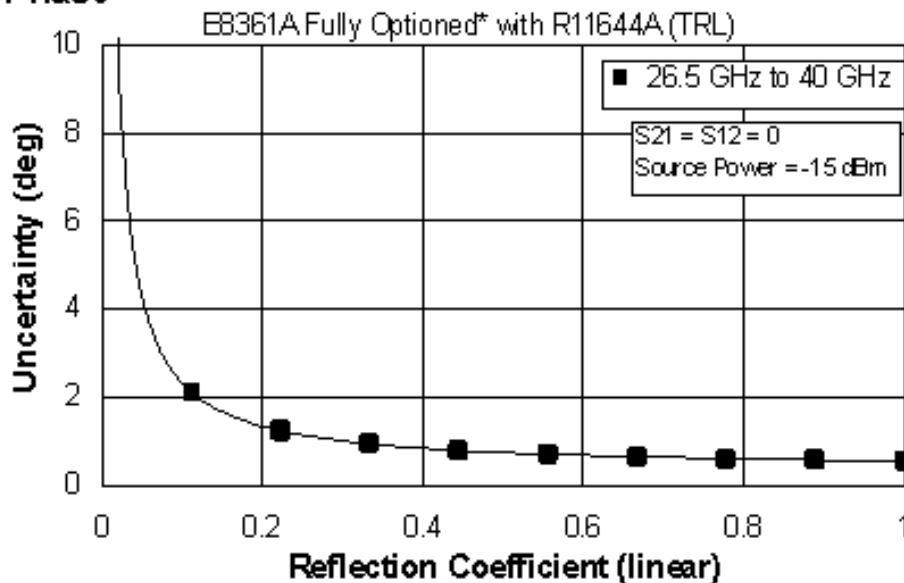

\* Configurable Test Set, and Frequency Offset Mode (E8361A - Option 014, and 080)



## E8361A Corrected System Performance with WR-42 Connectors

**Table 26.** K11644A Calibration Kit

E8361A - Standard Configuration and Standard Power Range

Applies to the, E8361A analyzers, K11644A (WR-42) calibration kit, 85134F flexible test port cable set with the K281C launch set,, and a full 2-port calibration. Also applies to the following condition:

Environmental temperature 23° ±3 °C, with < 1 °C deviation from calibration temperature

Description	Specification (dB)	
	18 to 20 GHz	20 to 26.5 GHz
Directivity	50	50
Source Match	50	50
Load Match	50	50
Reflection Tracking	±0.000 +0.02/°C	±0.000 +0.02/°C
Transmission Tracking	±0.017 +0.02/°C	±0.023 +0.02/°C

## Transmission Uncertainty (Specifications)

### Magnitude

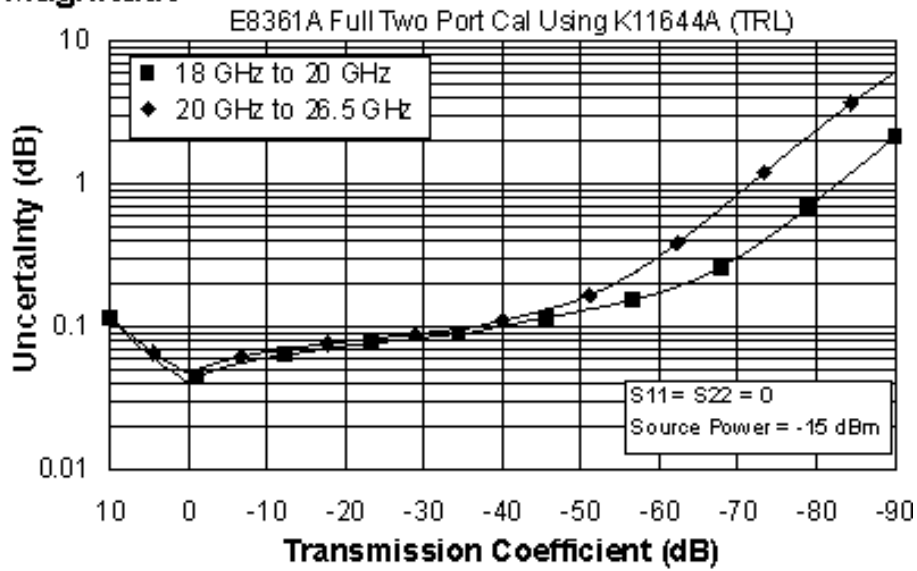

### Phase

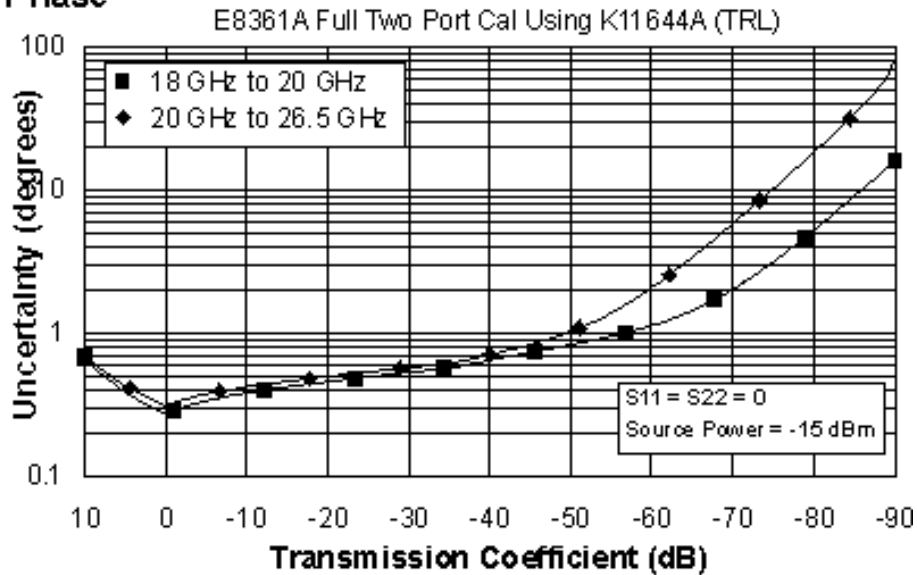

## Reflection Uncertainty (Specifications)

### Magnitude

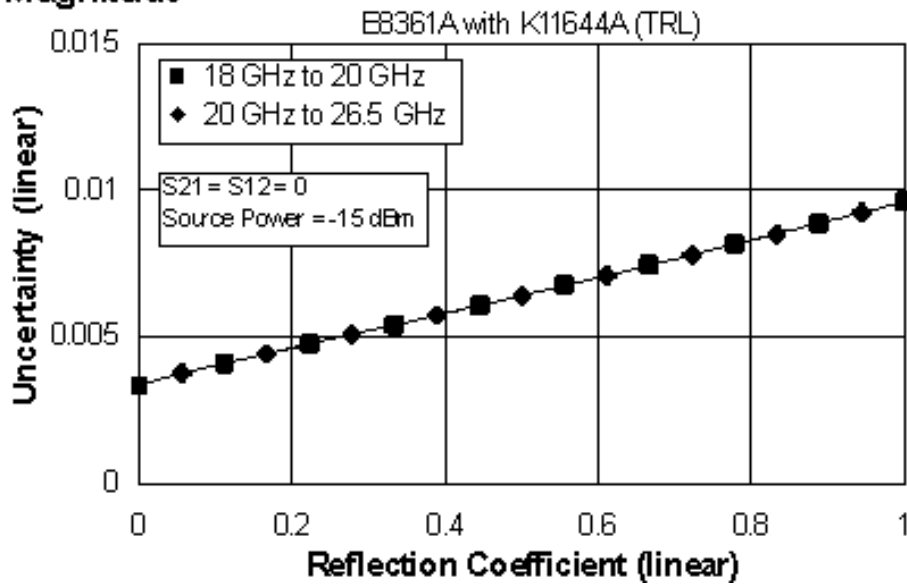

### Phase

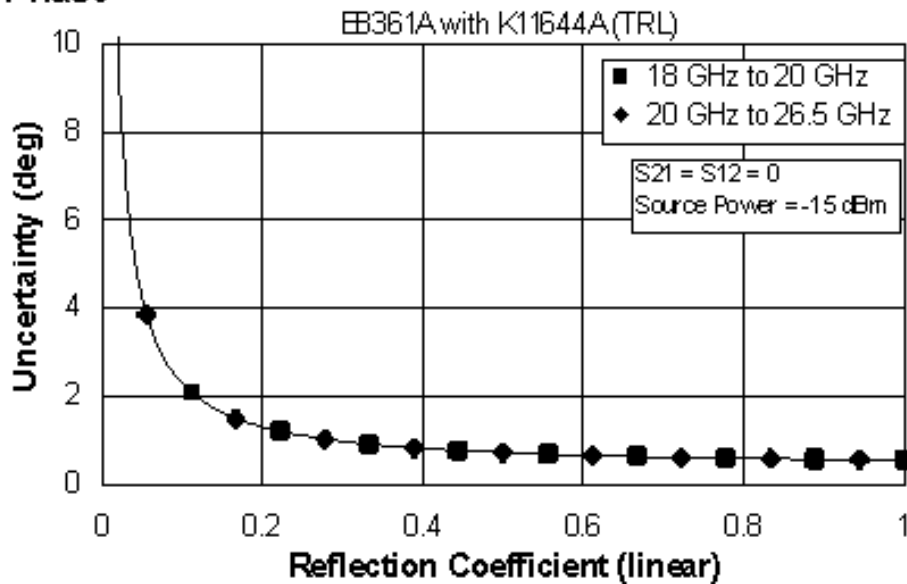

**Table 27. K11644A Calibration Kit**  
 E8361A - Fully Optioned (Option 014, and 080)  
 Configurable Test Set, and Frequency Offset Mode

Applies to the, E8361A analyzers, K11644A (WR-42) calibration kit, 85134F flexible test port cable set with the K281C launch set,, and a full 2-port calibration. Also applies to the following condition:

Environmental temperature 23° ±3 °C, with < 1 °C deviation from calibration temperature

Description	Specification (dB)	
	18 to 20 GHz	20 to 26.5 GHz
Directivity	50	50
Source Match	50	50
Load Match	50	50
Reflection Tracking	±0.000 +0.02/°C	±0.000 +0.02/°C
Transmission Tracking	±0.019 +0.02/°C	±0.020 +0.02/°C

## Transmission Uncertainty (Specifications)

### Magnitude

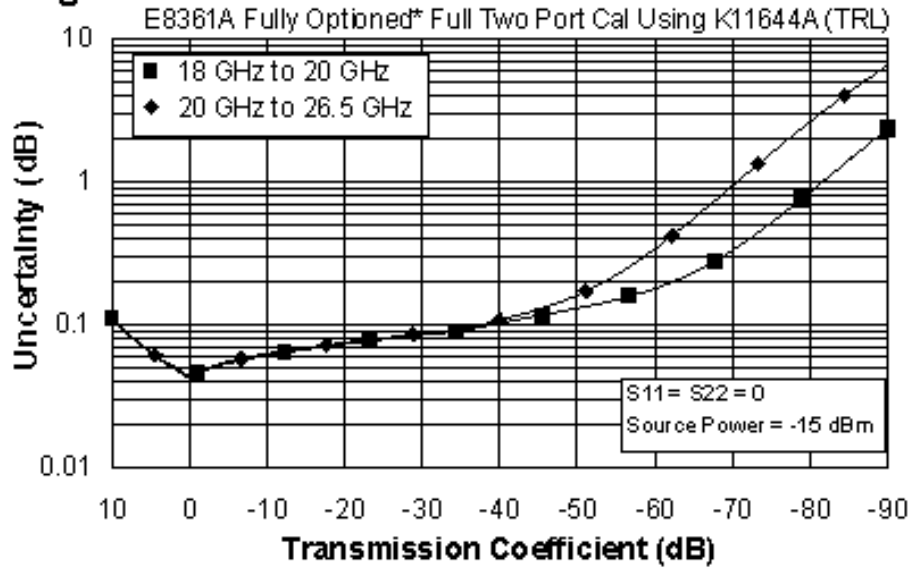

### Phase

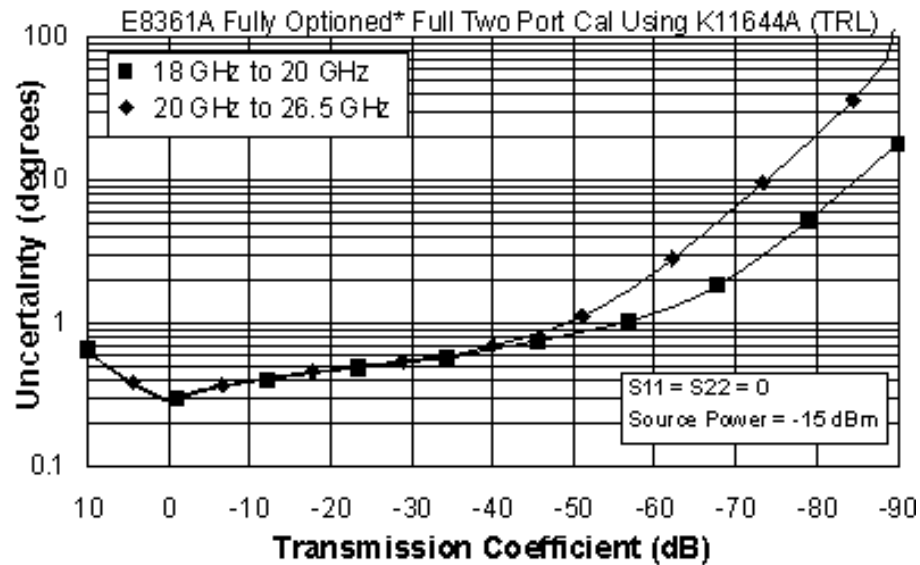

\* Configurable Test Set, and Frequency Offset Mode (E8361A - Option 014, and 080)

## Reflection Uncertainty (Specifications)

### Magnitude

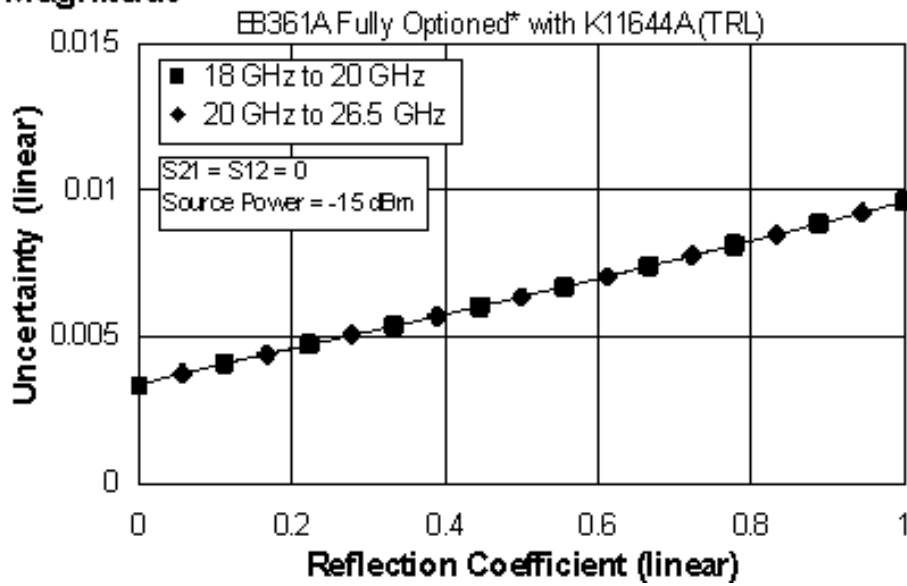

### Phase

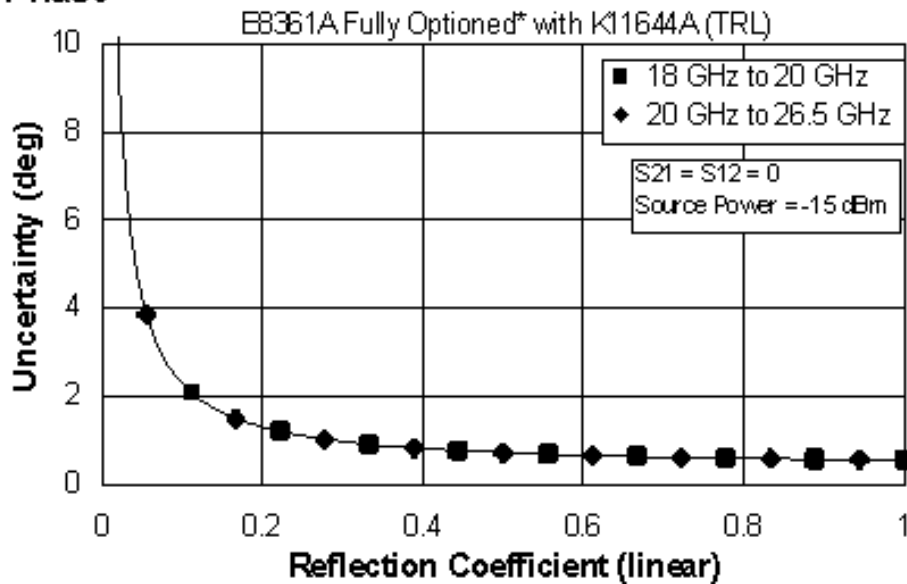

\* Configurable Test Set, and Frequency Offset Mode (E8361A - Option 014, and 080)

## E8361A Corrected System Performance with WR-62 Connectors

**Table 28.** P11644A Calibration Kit

E8361A - Standard Configuration and Standard Power Range

Applies to the, E8361A analyzers, P11644A (WR-62) calibration kit, 85132F flexible test port cable set with the P281B and P281C launch sets, and a full 2-port calibration. Also applies to the following condition:

Environmental temperature  $23^{\circ} \pm 3^{\circ} \text{C}$ , with  $< 1^{\circ} \text{C}$  deviation from calibration temperature

Description	Specification (dB)
	<b>12.4 to 18 GHz</b>
Directivity	50
Source Match	50
Load Match	50
Reflection Tracking	$\pm 0.000$ $+0.02/^{\circ}\text{C}$
Transmission Tracking	$\pm 0.017$ $+0.02/^{\circ}\text{C}$

## Transmission Uncertainty (Specifications)

### Magnitude

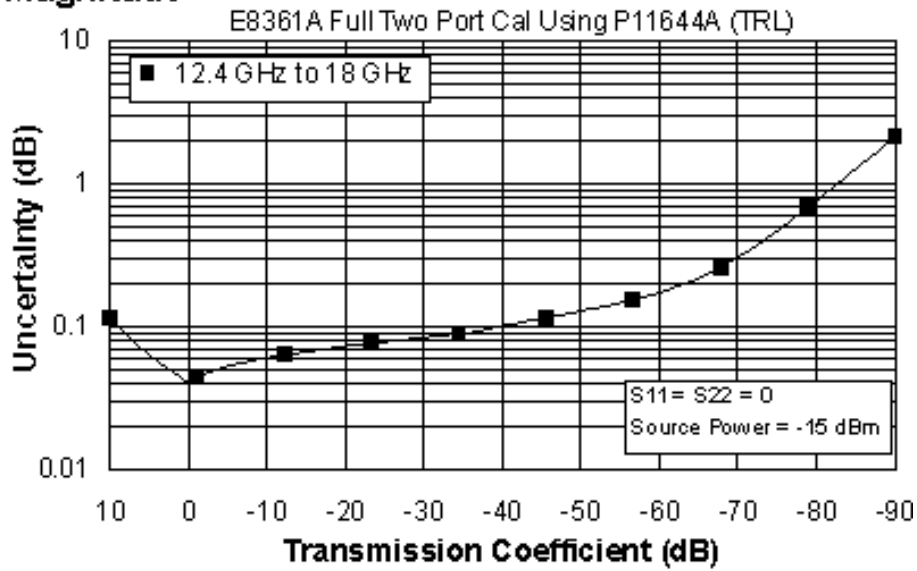

### Phase

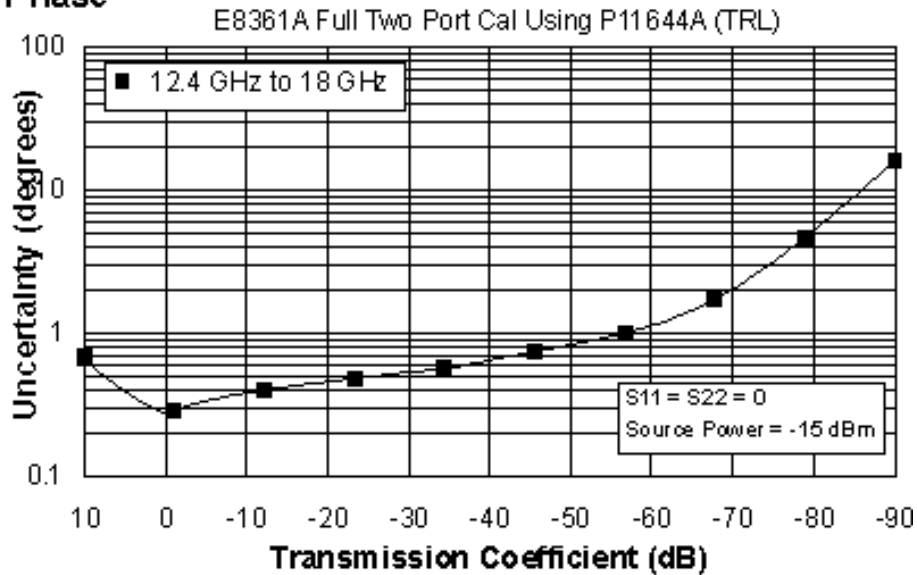



Reflection Uncertainty (Specifications)

Magnitude

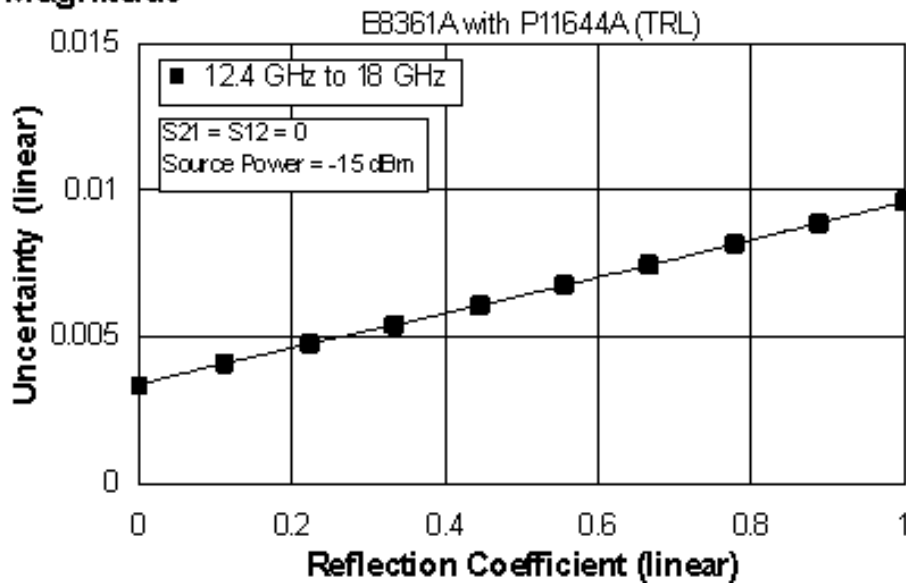

Phase

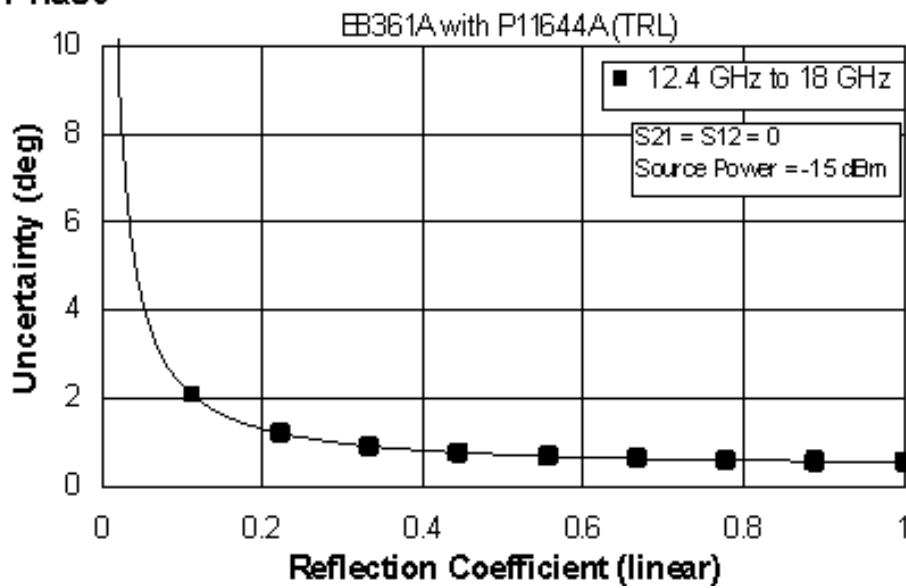

**Table 29.** P11644A Calibration Kit  
 E8361A - Fully Optioned (Option 014, and 080)  
 Configurable Test Set, and Frequency Offset Mode

Applies to the, E8361A analyzers, P11644A (WR-62) calibration kit, 85132F flexible test port cable set with the P281B and P281C launch sets, and a full 2-port calibration. Also applies to the following condition:

Environmental temperature  $23^{\circ} \pm 3^{\circ} \text{C}$ , with  $< 1^{\circ} \text{C}$  deviation from calibration temperature

Description	Specification (dB)
	<b>12.4 to 18 GHz</b>
Directivity	50
Source Match	50
Load Match	50
Reflection Tracking	$\pm 0.000$ $+0.02/^{\circ}\text{C}$
Transmission Tracking	$\pm 0.019$ $+0.02/^{\circ}\text{C}$

## Transmission Uncertainty (Specifications)

### Magnitude

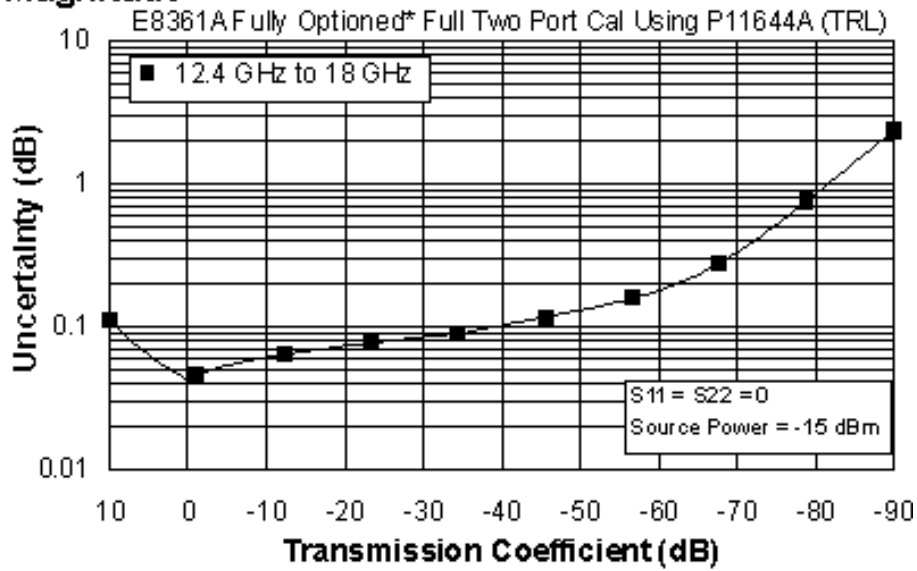

### Phase

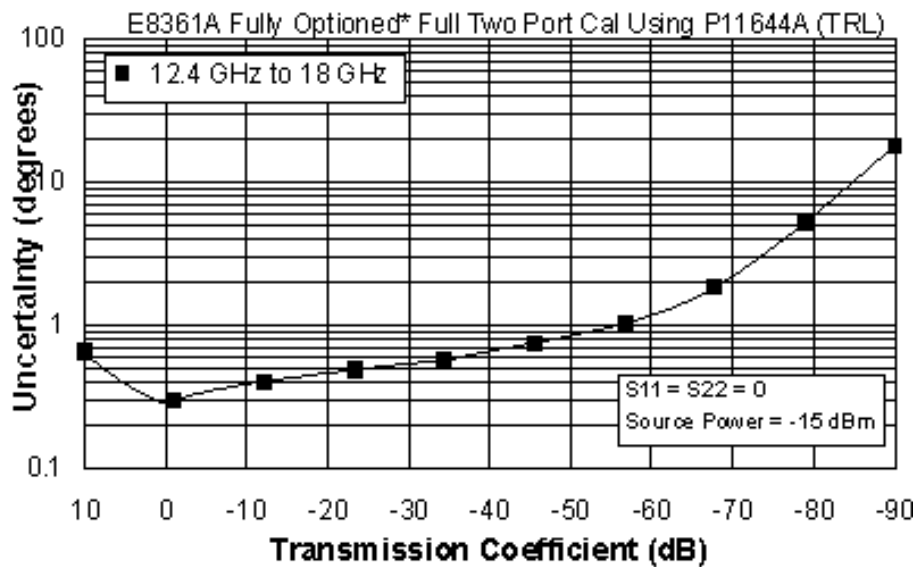

\* Configurable Test Set and Frequency Offset Mode (E8361A - Option 014, and 080)

## Reflection Uncertainty (Specifications)

### Magnitude

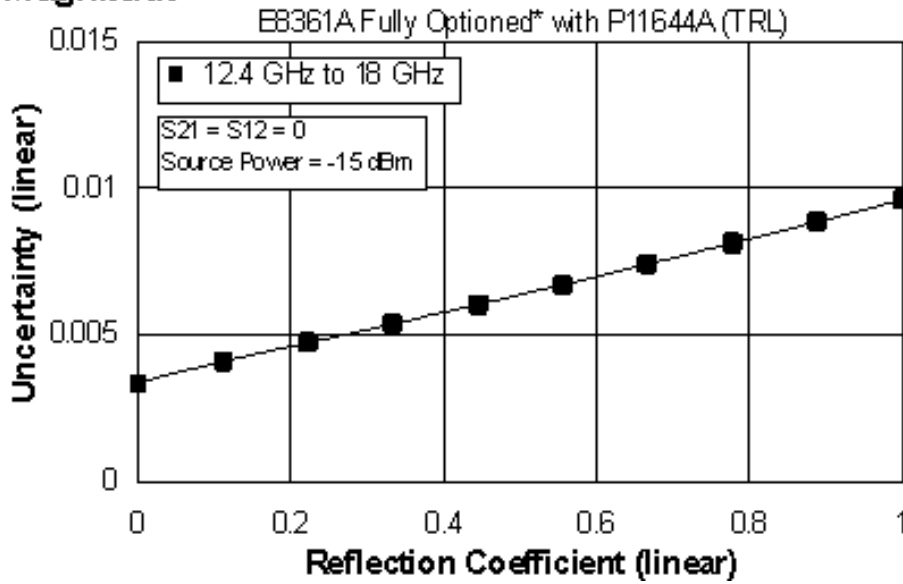

### Phase

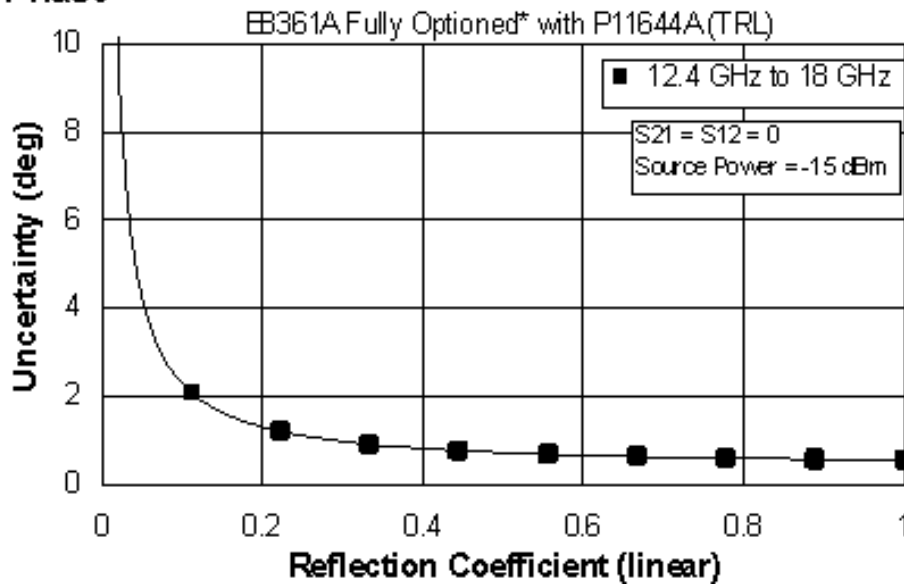

\* Configurable Test Set and Frequency Offset Mode (E8361A - Option 014, and 080)

## E8361A Corrected System Performance with WR-90 Connectors

**Table 30.** X11644A Calibration Kit

### E8361A - Standard Configuration and Standard Power Range

Applies to the, E8361A analyzers, X11644A (WR-90) calibration kit, 85133F flexible test port cable set with the X281A and X281C launch sets, and a full 2-port calibration. Also applies to the following condition:

Environmental temperature  $23^{\circ} \pm 3^{\circ} \text{C}$ , with  $< 1^{\circ} \text{C}$  deviation from calibration temperature

Description	Specification (dB)
	<b>8.2 to 12.4 GHz</b>
Directivity	50
Source Match	50
Load Match	50
Reflection Tracking	$\pm 0.000$ $+0.02/^{\circ}\text{C}$
Transmission Tracking	$\pm 0.017$ $+0.02/^{\circ}\text{C}$

## Transmission Uncertainty (Specifications)

### Magnitude

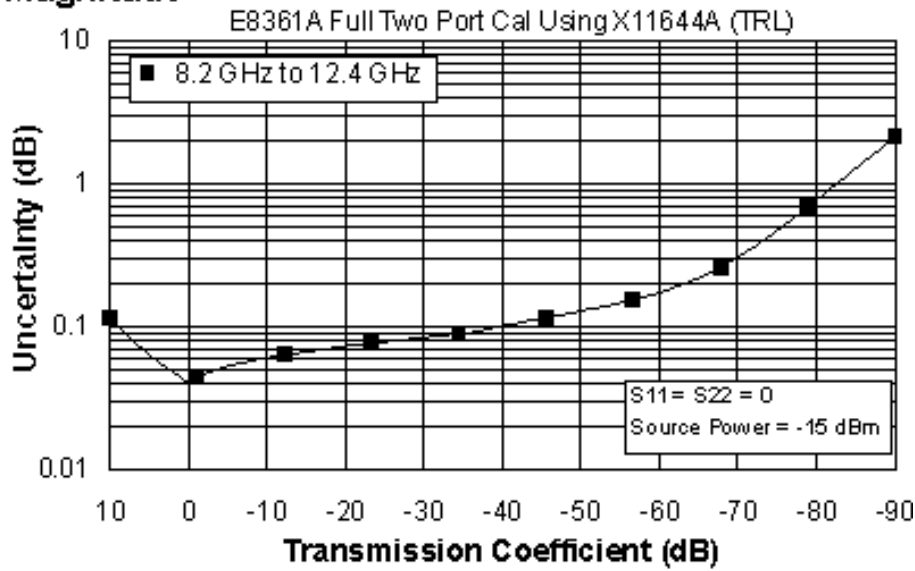

### Phase

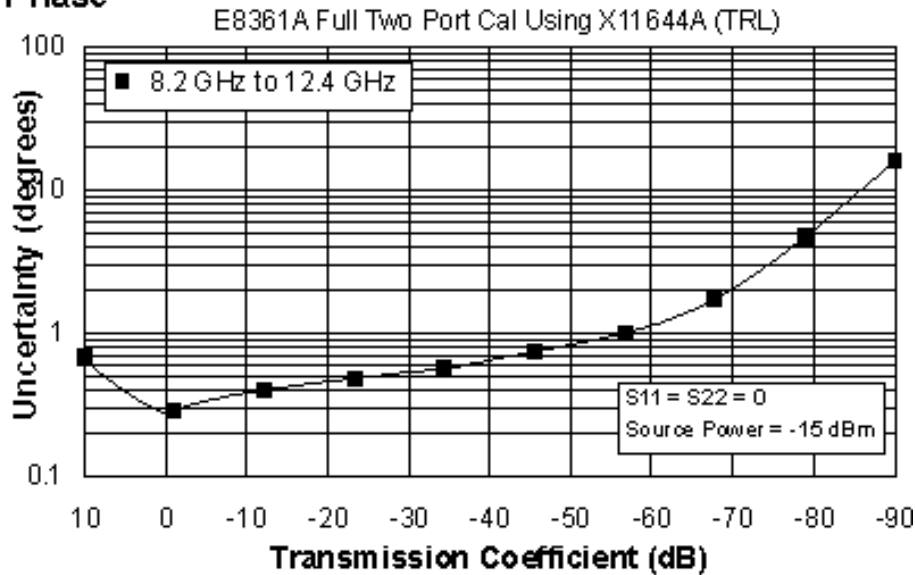

## Reflection Uncertainty (Specifications)

### Magnitude

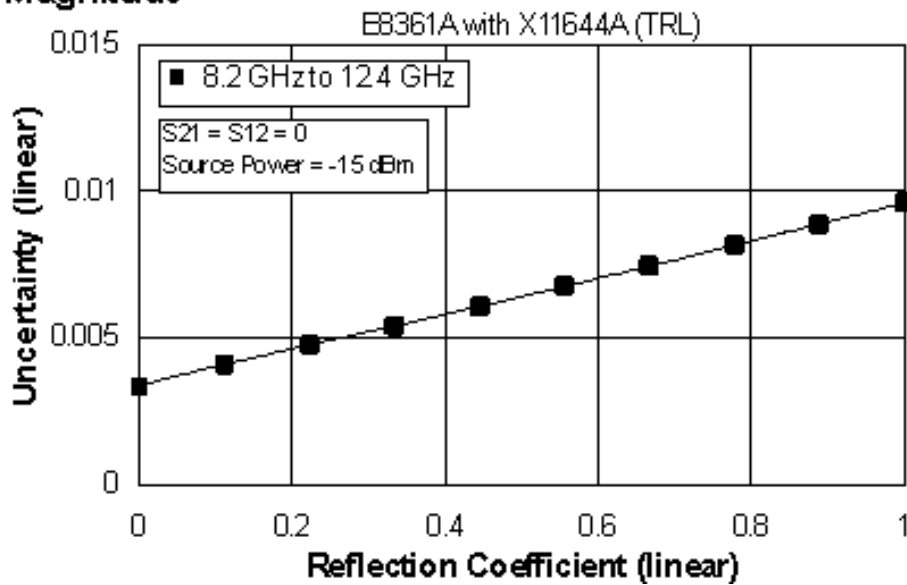

### Phase

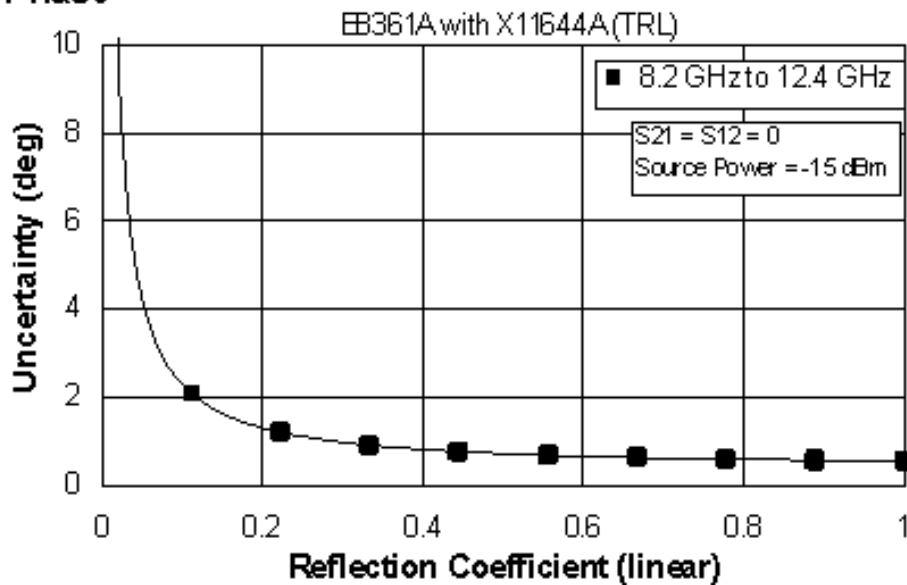

**Table 31. X11644A Calibration Kit**  
 E8361A - Fully Optioned (Option 014, and 080)  
 Configurable Test Set, and Frequency Offset Mode

Applies to the, E8361A analyzers, X11644A (WR-90) calibration kit, 85133F flexible test port cable set with the X281A and X281C launch sets, and a full 2-port calibration. Also applies to the following condition:

Environmental temperature 23° ±3 °C, with < 1 °C deviation from calibration temperature

Description	Specification (dB)
	8.2 to 12.4 GHz
Directivity	50
Source Match	50
Load Match	50
Reflection Tracking	±0.000 +0.02/°C
Transmission Tracking	±0.019 +0.02/°C



## Transmission Uncertainty (Specifications)

### Magnitude

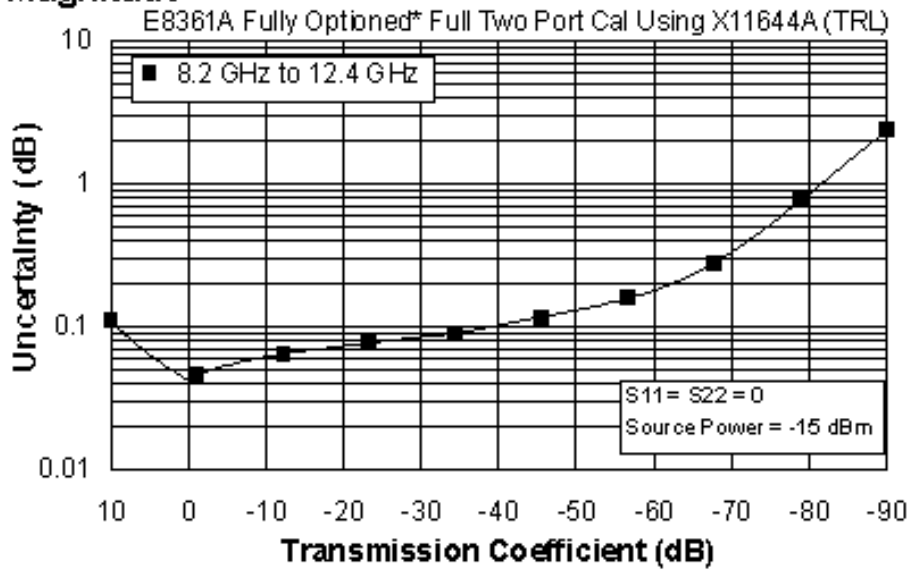

### Phase

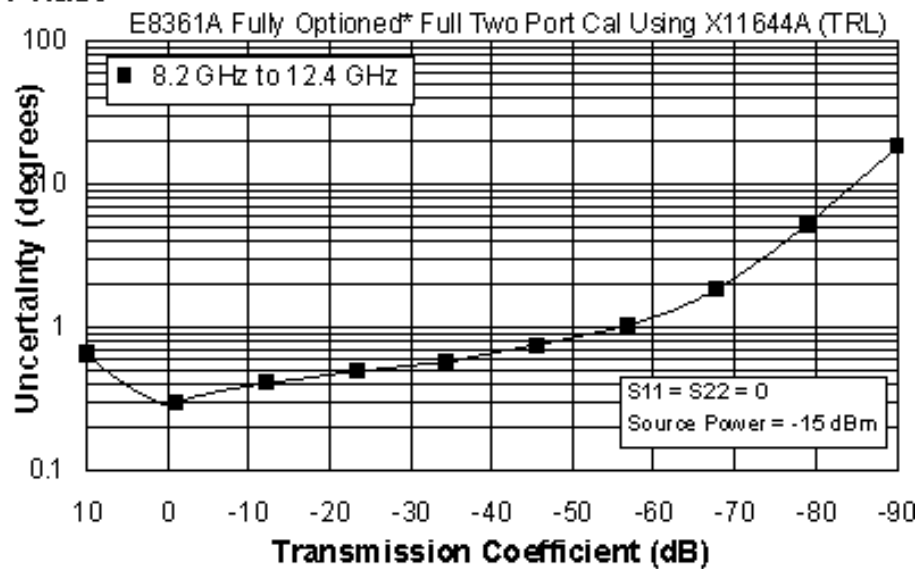

\* Configurable Test Set, and Frequency Offset Mode (E8361A - Option 014, and 080)

## Reflection Uncertainty (Specifications)

### Magnitude

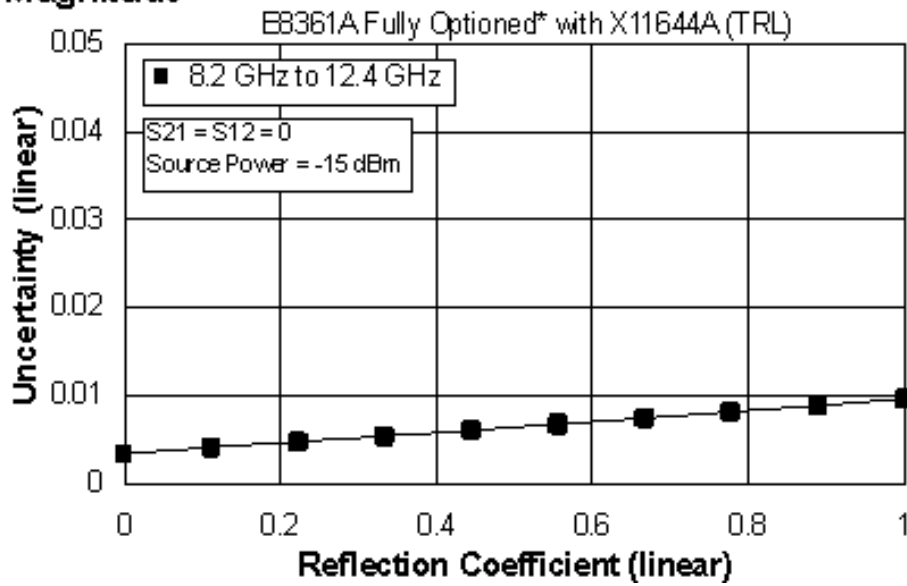

### Phase

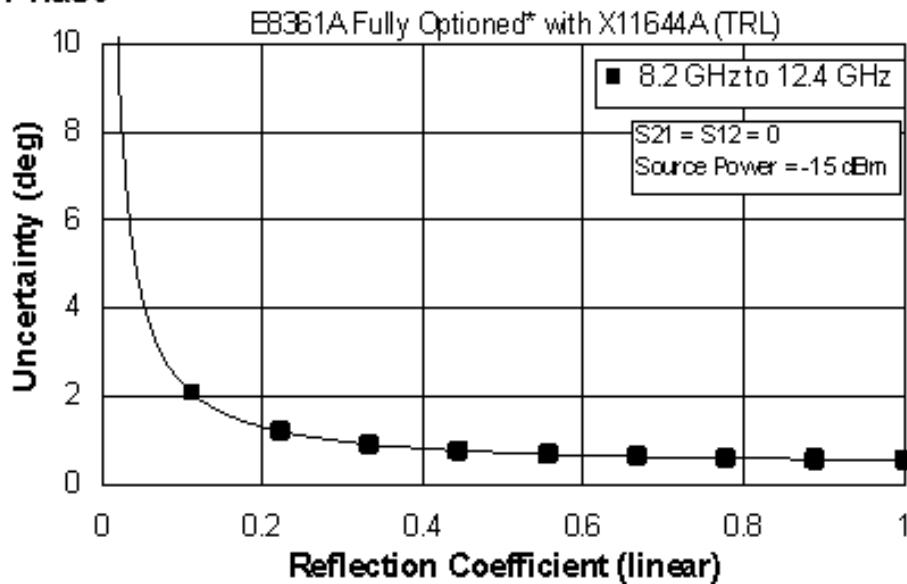

\* Configurable Test Set, and Frequency Offset Mode (E8361A - Option 014, and 080)

**Table 32. Uncorrected System Performance<sup>a</sup>**

Specifications apply over environmental temperature of 23° ±3 °C, with &lt; 1 °C deviation from the calibration temperature

Description	Specification	Supplemental Information
<b>Directivity</b>		
		<b>typical:</b>
10 MHz to 45 MHz <sup>b</sup>	22 dB	22 dB
45 MHz to 2 GHz	24 dB	27 dB
2 GHz to 10 GHz	20 dB	24 dB
10 GHz to 20 GHz	16 dB	20 dB
20 GHz to 30 GHz	14 dB	17 dB
30 GHz to 50 GHz	13 dB	17 dB
50 GHz to 60 GHz	13 dB	17 dB
60 GHz to 67 GHz	10 dB	18 dB
67 GHz to 70 GHz <sup>b</sup>	14 dB	14 dB
<b>Source Match - Standard</b>		
		<b>typical:</b>
10 MHz to 45 MHz <sup>b</sup>	7 dB	7 dB
45 MHz to 2 GHz	18 dB	23 dB
2 GHz to 10 GHz	14 dB	18 dB
10 GHz to 20 GHz	12 dB	15 dB
20 GHz to 30 GHz	8 dB	11.5 dB
30 GHz to 40 GHz	7.5 dB	10 dB
40 GHz to 45 GHz	8 dB	11 dB
45 GHz to 50 GHz	7 dB	10 dB
50 GHz to 60 GHz	6 dB	8.5 dB
60 GHz to 67 GHz	5.5 dB	7.5 dB
67 GHz to 70 GHz <sup>b</sup>	7.5 dB	7.5
<b>Source Match - Option 014</b>		
		<b>typical:</b>
10 MHz to 45 MHz <sup>b</sup>	7 dB	7 dB
45 MHz to 2 GHz	17 dB	21 dB
2 GHz to 10 GHz	12 dB	17 dB
10 GHz to 20 GHz	11 dB	14 dB
20 GHz to 30 GHz	10 dB	13 dB
30 GHz to 40 GHz	8.5 dB	11 dB
40 GHz to 45 GHz	8.5 dB	11 dB
45 GHz to 50 GHz	8.5 dB	11.5 dB
50 GHz to 60 GHz	6.5 dB	9 dB
60 GHz to 67 GHz	6 dB	8.5 dB
67 GHz to 70 GHz <sup>b</sup>	8.5 dB	8.5 dB
<b>Load Match - Standard</b>		
		<b>typical:</b>
10 MHz to 45 MHz <sup>b</sup>	5.5 dB	5.5 dB
45 MHz to 2 GHz	9 dB	10 dB
2 GHz to 10 GHz	9 dB	11 dB
10 GHz to 20 GHz	8.5 dB	10 dB
20 GHz to 30 GHz	7 dB	9 dB
30 GHz to 40 GHz	6 dB	8 dB
40 GHz to 45 GHz	6.5 dB	9 dB
45 GHz to 50 GHz	6.5 dB	8.5 dB
50 GHz to 60 GHz	5.5 dB	7.5 dB
60 GHz to 67 GHz	5.5 dB	7.5 dB
67 GHz to 70 GHz <sup>b</sup>	5 dB	5 dB

<b>Load Match - Option 014</b>		
		<b>typical:</b>
10 MHz to 45 MHz <sup>b</sup>	5.5 dB	5.5 dB
45 MHz to 2 GHz	8.5 dB	10 dB
2 GHz to 10 GHz	8 dB	10 dB
10 GHz to 20 GHz	8 dB	10 dB
20 GHz to 30 GHz	7.5 dB	10 dB
30 GHz to 40 GHz	7 dB	9.5 dB
40 GHz to 45 GHz	7.5 dB	9.5 dB
45 GHz to 50 GHz	7.5 dB	10 dB
50 GHz to 60 GHz	6 dB	8.5 dB
60 GHz to 67 GHz	6 dB	8.5 dB
67 GHz to 70 GHz <sup>b</sup>	5 dB	5 dB
<b>Reflection Tracking</b>		
		<b>typical:</b>
10 MHz to 45 MHz		±1.5 dB
45 MHz to 20 GHz		±1.5 dB
20 GHz to 40 GHz		±2.0 dB
40 GHz to 50 GHz		±2.0 dB
50 GHz to 67 GHz		±3.0 dB
67 GHz to 70 GHz		±4.5 dB
<b>Transmission Tracking<sup>c</sup></b>		
		<b>typical:</b>
10 MHz to 45 MHz		±1.5 dB
45 MHz to 20 GHz		±1.5 dB
20 GHz to 40 GHz		±2.0 dB
40 GHz to 50 GHz		±2.0 dB
50 GHz to 67 GHz		±3.0 dB
67 GHz to 70 GHz		±4.5 dB
<b>Crosstalk<sup>d</sup> - Standard</b>		
10 MHz to 45 MHz <sup>b</sup>	-63 dB	
45 MHz to 500 MHz	-87 dB	
500 MHz to 2 GHz	-110 dB	
2 GHz to 10 GHz	-105 dB	
10 GHz to 24 GHz	-111 dB	
24 GHz to 30 GHz	-106 dB	
30 GHz to 40 GHz	-104 dB	
40 GHz to 45 GHz	-98 dB	
45 GHz to 50 GHz	-100 dB	
50 GHz to 60 GHz	-97 dB	
60 GHz to 67 GHz	-94 dB	
67 GHz to 70 GHz <sup>b</sup>	-94 dB	
<b>Crosstalk<sup>d</sup> - Option 014</b>		
10 MHz to 45 MHz <sup>b</sup>	-63 dB	
45 MHz to 500 MHz	-87 dB	
500 MHz to 2 GHz	-110 dB	
2 GHz to 10 GHz	-105 dB	
10 GHz to 24 GHz	-111 dB	
24 GHz to 30 GHz	-104 dB	
30 GHz to 40 GHz	-102 dB	
40 GHz to 45 GHz	-96 dB	
45 GHz to 50 GHz	-98 dB	
50 GHz to 60 GHz	-95 dB	
60 GHz to 67 GHz	-90 dB	
67 GHz to 70 GHz <sup>b</sup>	-90 dB	

Crosstalk - Option 014 and Option 080 enabled <sup>e</sup>		
		<b>typical:</b>
10 MHz to 45 MHz <sup>b</sup>		-63 dB
45 MHz to 500 MHz		-87 dB
500 MHz to 2 GHz		-110 dB
2 GHz to 10 GHz		-105 dB
10 GHz to 24 GHz		-111 dB
24 GHz to 30 GHz		-104 dB
30 GHz to 40 GHz		-102 dB
40 GHz to 45 GHz		-96 dB
45 GHz to 50 GHz		-98 dB
50 GHz to 60 GHz		-95 dB
60 GHz to 67 GHz		-90 dB
67 GHz to 70 GHz <sup>b</sup>		-90 dB

<sup>a</sup> Specifications apply over environment temperature of 23°C +/- 3°C, with less than 1°C deviation from the calibration temperature.

<sup>b</sup> Typical performance.

<sup>c</sup> Transmission tracking performance noted here is normalized to the insertion loss characteristics of the cable used so that the indicated performance is independent of the cable used.

<sup>d</sup> Measurement conditions: normalized to a thru, measured with two shorts, 10 Hz IF bandwidth, averaging factor of 8, alternate mode, source power set to the lesser of the maximum power out or the maximum receiver power.

<sup>e</sup> 0 Hz offset.

**Table 33. Test Port Output**

Description	Specification		Supplemental
<b>Frequency Range</b>			
	<b>Standard</b>	<b>Opt 014</b>	
E8361A	10 MHz to 67 GHz (Operates up to 70 GHz)		
<b>Nominal Power<sup>3</sup></b>			
E8361A	-15 dBm		
<b>Frequency Resolution</b>			
	1 Hz		
<b>CW Accuracy</b>			
	+/-1 ppm		
<b>Frequency Stability</b>			
			+/-1 ppm. 0° to 40° C, typical +/- 0.2 ppm/yr, typical

<b>Power Level Accuracy<sup>1</sup></b>			
	<b>Standard</b>	<b>Opt 014</b>	
10 MHz to 45 MHz <sup>2</sup>	+/-1.5 dB	+/-1.5 dB	Variation from nominal power in range 0
45 MHz to 10 GHz	+/-1.5 dB	+/-1.5 dB	
10 GHz to 20 GHz	+/-1.5 dB	+/-1.5 dB	
20 GHz to 40 GHz	+/-2.0 dB	+/-2.0 dB	
40 GHz to 45 GHz	+/-3.0 dB	+/-3.0 dB	
45 GHz to 50 GHz	+/-3.5 dB	+/-3.5 dB	
50 GHz to 60 GHz	+/-4.0 dB	+/-4.0 dB	
60 GHz to 67 GHz	+/-4.0 dB	+/-4.0 dB	
67 GHz to 70 GHz <sup>2</sup>	+/-4.0 dB	+/-4.0 dB	
<b>Power Level Linearity<sup>4</sup></b>			
	<b>Standard</b>	<b>Opt 014</b>	
			Test reference is at the nominal power level
10 MHz to 45 MHz <sup>2</sup>	+/-1.0 dB for power<-5 dBm <sup>7</sup>		
45 MHz to 67 GHz	+/-1.0 dB for power<-5 dBm <sup>7</sup>		
67 GHz to 70 GHz <sup>2</sup>	+/-1.0 dB for power<-5 dBm <sup>7</sup>		

<b>Power Range<sup>1, 5, 6</sup></b>			
	<b>Standard</b>	<b>Opt 014</b>	
10 MHz to 45 MHz <sup>2</sup>	-25 to -7 dBm	-25 to -7 dBm	
45 MHz to 500 MHz	-25 to -3 dBm	-25 to -3 dBm	
500 MHz to 750 MHz	-25 to 0 dBm	-25 to 0 dBm	
750 MHz to 10 GHz	-27 to 0 dBm	-27 to 0 dBm	
10 GHz to 30 GHz	-27 to +1 dBm	-27 to 0 dBm	
30 GHz to 40 GHz	-27 to -1 dBm	-27 to -2 dBm	
40 GHz to 45 GHz	-27 to -5 dBm	-27 to -6 dBm	
45 GHz to 50 GHz	-27 to -1 dBm	-27 to -2 dBm	
50 GHz to 60 GHz	-27 to -3 dBm	-27 to -4 dBm	
60 GHz to 67 GHz	-27 to -5 dBm	-27 to -7 dBm	
67 GHz to 70 GHz <sup>2</sup>	-27 to -5 dBm	-27 to -7 dBm	
<b>Power Sweep Range (ALC)</b>			
	<b>Standard</b>	<b>Opt 014</b>	
10 MHz to 45 MHz <sup>2</sup>	18 dB	18 dB	ALC range starts at maximum leveled output power and goes down to power level indicated by dB amount specified.
45 MHz to 500 MHz	22 dB	22 dB	
500 MHz to 750 MHz	25 dB	25 dB	
750 MHz to 10 GHz	27 dB	27 dB	
10 GHz to 30 GHz	28 dB	27 dB	
30 GHz to 40 GHz	26 dB	25 dB	
40 GHz to 45 GHz	22 dB	21 dB	
45 GHz to 50 GHz	26 dB	25 dB	
50 GHz to 60 GHz	24 dB	23 dB	
60 GHz to 67 GHz	22 dB	20 dB	
67 GHz to 70 GHz <sup>2</sup>	22 dB	20 dB	
<b>Power Resolution</b>			
	0.01 dB		

<b>Phase Noise</b>			
	<b>Standard</b>	<b>Opt 014</b>	
<b>10 kHz offset from center frequency, nominal power at test port</b>			
			<b>typical:</b>
10 MHz to 45 MHz			-80 dBc
45 MHz to 10 GHz			-70 dBc
10 GHz to 24 GHz			-60 dBc
24 GHz to 70 GHz			-55 dBc
<b>10 kHz offset from center frequency, nominal power at test port - Option 080 enabled</b>			
			<b>typical:</b>
10 MHz to 45 MHz			-80 dBc
45 MHz to 10 GHz			-70 dBc
10 GHz to 24 GHz			-60 dBc
24 GHz to 70 GHz			-55 dBc
<b>100 kHz offset from center frequency, nominal power at test port</b>			
			<b>typical:</b>
10 MHz to 45 MHz			-90 dBc
45 MHz to 10 GHz			-90 dBc
10 GHz to 24 GHz			-85 dBc
24 GHz to 70 GHz			-75 dBc
<b>100 kHz offset from center frequency, nominal power at test port - Option 080 enabled</b>			
			<b>typical:</b>
10 MHz to 45 MHz			-85 dBc
45 MHz to 10 GHz			-80 dBc
10 GHz to 24 GHz			-70 dBc
24 GHz to 70 GHz			-60 dBc
<b>1 MHz offset from center frequency, nominal power at test port</b>			
			<b>typical:</b>
10 MHz to 45 MHz			-115 dBc
45 MHz to 10 GHz			-110 dBc
10 GHz to 24 GHz			-105 dBc
24 GHz to 70 GHz			-95 dBc



<b>1 MHz offset from center frequency, nominal power at test port - Option 080 enabled</b>			
			<b>typical:</b>
10 MHz to 45 MHz			-110 dBc
45 MHz to 10 GHz			-105 dBc
10 GHz to 24 GHz			-95 dBc
24 GHz to 70 GHz			-85 dBc
<b>Harmonics (2nd or 3rd)</b>			
	<b>Standard</b>	<b>Opt 014</b>	
			<b>typical:</b>
10 MHz to 500 MHz			-10 dBc
500 MHz to 10 GHz			-15 dBc
10 GHz to 24 GHz			-23 dBc
24 GHz to 50 GHz			-16 dBc
50 GHz to 60 GHz			-13 dBc
60 GHz to 70 GHz			-19 dBc
<b>Non-Harmonic Spurious (at Nominal Output Power)</b>			
	<b>Standard</b>	<b>Opt 014</b>	
10 MHz to 20 GHz			-50 dBc typical, for offset frequency > 1 kHz
20 GHz to 70 GHz			-30 dBc typical, for offset frequency > 1 kHz

<sup>1</sup> Performance specified on Port 1 only. Port 2 output performance is a characteristic.

<sup>2</sup> Typical performance.

<sup>3</sup> Preset power.

<sup>4</sup> Power Level Linearity specified on Port 1 only; Port 2 performance is typical.

<sup>5</sup> Test port power is specified into nominal 50 ohms.

<sup>6</sup> Power to which the source can be set and phase lock is assured.

<sup>7</sup> +/-1.6 dBm for power >= -5 dBm

**Table 34: Test Port Input**

Description	Specification		Supplemental
	Standard	Opt 014	
<b>Test Port Noise Floor<sup>a</sup></b>			
<b>10 Hz IF Bandwidth</b>			
10 MHz to 45 MHz <sup>b</sup>	<-70 dBm	<-70 dBm	
45 MHz to 500 MHz <sup>c</sup>	<-90 dBm	<-90 dBm	
500 MHz to 2 GHz	<-112 dBm	<-112 dBm	
2 GHz to 10 GHz	<-112 dBm	<-112 dBm	
10 GHz to 24 GHz	<-116 dBm	<-115 dBm	
24 GHz to 30 GHz	<-105 dBm	<-104 dBm	
30 GHz to 40 GHz	<-105 dBm	<-104 dBm	
40 GHz to 45 GHz	<-103 dBm	<-102 dBm	
45 GHz to 50 GHz	<-101 dBm	<-100 dBm	
50 GHz to 60 GHz	<-100 dBm	<-99 dBm	
60 GHz to 67 GHz	<-99 dBm	<-97 dBm	
67 GHz to 70 GHz <sup>b</sup>	<-99 dBm	<-97 dBm	
<b>1 KHz IF Bandwidth</b>			
10 MHz to 45 MHz <sup>b</sup>	<-50 dBm	<-50 dBm	
45 MHz to 500 MHz <sup>c</sup>	<-70 dBm	<-70 dBm	
500 MHz to 2 GHz	<-92 dBm	<-92 dBm	
2 GHz to 10 GHz	<-92 dBm	<-92 dBm	
10 GHz to 24 GHz	<-96 dBm	<-95 dBm	
24 GHz to 30 GHz	<-85 dBm	<-84 dBm	
30 GHz to 40 GHz	<-85 dBm	<-84 dBm	
40 GHz to 45 GHz	<-83 dBm	<-82 dBm	
45 GHz to 50 GHz	<-81 dBm	<-80 dBm	
50 GHz to 60 GHz	<-80 dBm	<-79 dBm	
60 GHz to 67 GHz	<-79 dBm	<-77 dBm	
67 GHz to 70 GHz <sup>b</sup>	<-79 dBm	<-77 dBm	
<b>Test Port Noise Floor<sup>a</sup> Option 080 enabled<sup>d</sup></b>			
	<b>Standard</b>	<b>Option 014</b>	
<b>10 Hz IF Bandwidth</b>			
			<b>typical:</b>
10 MHz to 45 MHz			<-70 dBm
45 MHz to 500 MHz <sup>c</sup>			<-90 dBm
500 MHz to 2 GHz			<-112 dBm
2 GHz to 10 GHz			<-112 dBm
10 GHz to 24 GHz			<-115 dBm
24 GHz to 30 GHz			<-104 dBm
30 GHz to 40 GHz			<-104 dBm
40 GHz to 45 GHz			<-102 dBm
45 GHz to 50 GHz			<-100 dBm
50 GHz to 60 GHz			<-99 dBm
60 GHz to 67 GHz			<-97 dBm
67 GHz to 70 GHz			<-97 dBm

<b>1 KHz IF Bandwidth</b>			
			<b>typical:</b>
10 MHz to 45 MHz			<-50 dBm
45 MHz to 500 MHz <sup>c</sup>			<-70 dBm
500 MHz to 2 GHz			<-92 dBm
2 GHz to 10 GHz			<-92 dBm
10 GHz to 24 GHz			<-95 dBm
24 GHz to 30 GHz			<-84 dBm
30 GHz to 40 GHz			<-84 dBm
40 GHz to 45 GHz			<-82 dBm
45 GHz to 50 GHz			<-80 dBm
50 GHz to 60 GHz			<-79 dBm
60 GHz to 67 GHz			<-77 dBm
67 GHz to 70 GHz			<-77 dBm
<b>Direct Receiver Access Input Noise Floor<sup>a</sup></b>			
	<b>Standard</b>	<b>Option 014</b>	
<b>10 Hz IF Bandwidth</b>			
10 MHz to 45 MHz <sup>b</sup>		<-106 dBm	
45 MHz to 500 MHz <sup>d</sup>		<-105 dBm	
500 MHz to 2 GHz		<-125.5 dBm	
2 GHz to 10 GHz		<-125 dBm	
10 GHz to 24 GHz		<-128 dBm	
24 GHz to 30 GHz		<-117.5 dBm	
30 GHz to 40 GHz		<-117 dBm	
40 GHz to 45 GHz		<-115 dBm	
45 GHz to 50 GHz		<-112.5 dBm	
50 GHz to 60 GHz		<-111 dBm	
60 GHz to 67 GHz		<-108 dBm	
67 GHz to 70 GHz <sup>b</sup>		<-107 dBm	
<b>1 KHz IF Bandwidth</b>			
10 MHz to 45 MHz <sup>b</sup>		<-86 dBm	
45 MHz to 500 MHz <sup>d</sup>		<-85 dBm	
500 MHz to 2 GHz		<-105.5 dBm	
2 GHz to 10 GHz		<-105 dBm	
10 GHz to 24 GHz		<-108 dBm	
24 GHz to 30 GHz		<-97.5 dBm	
30 GHz to 40 GHz		<-97 dBm	
40 GHz to 45 GHz		<-95 dBm	
45 GHz to 50 GHz		<-92.5 dBm	
50 GHz to 60 GHz		<-91 dBm	
60 GHz to 67 GHz		<-88 dBm	
67 GHz to 70 GHz <sup>b</sup>		<-87 dBm	

Direct Receiver Access Input Noise Floor <sup>a</sup> - Option 080 enabled <sup>d</sup>			
	Standard	Option 014	
<b>10 Hz IF Bandwidth</b>			
			<b>typical:</b>
10 MHz to 45 MHz			<-106 dBm
45 MHz to 500 MHz <sup>d</sup>			<-105 dBm
500 MHz to 2 GHz			<-125.5 dBm
2 GHz to 10 GHz			<-125 dBm
10 GHz to 24 GHz			<-128 dBm
24 GHz to 30 GHz			<-117.5 dBm
30 GHz to 40 GHz			<-117 dBm
40 GHz to 45 GHz			<-115 dBm
45 GHz to 50 GHz			<-112.5 dBm
50 GHz to 60 GHz			<-111 dBm
60 GHz to 67 GHz			<-108 dBm
67 GHz to 70 GHz			<-107 dBm
<b>1 KHz IF Bandwidth</b>			
			<b>typical:</b>
10 MHz to 45 MHz			<-86 dBm
45 MHz to 500 MHz <sup>d</sup>			<-85 dBm
500 MHz to 2 GHz			<-105.5 dBm
2 GHz to 10 GHz			<-105 dBm
10 GHz to 24 GHz			<-108 dBm
24 GHz to 30 GHz			<-97.5 dBm
30 GHz to 40 GHz			<-97 dBm
40 GHz to 45 GHz			<-95 dBm
45 GHz to 50 GHz			<-92.5 dBm
50 GHz to 60 GHz			<-91 dBm
60 GHz to 67 GHz			<-88 dBm
67 GHz to 70 GHz			<-87 dBm
<b>Receiver Compression Level</b>			
	Standard	Option 014	
10 MHz to 45 MHz <sup>b, h</sup>	negligible		
45 MHz to 500 MHz <sup>h</sup>	<0.25 dB compression at -3 dBm		
500 MHz to 30 GHz	<0.25 dB compression at 0 dBm		
30 GHz to 67 GHz	<0.15 dB compression at -5 dBm	<0.15 dB compression at -7 dBm	
67 GHz to 70 GHz <sup>b</sup>	<0.15 dB compression at -5 dBm	<0.15 dB compression at -7 dBm	
<b>System Compression Level</b>			
	Standard	Option 014	
	maximum leveled output power		See <u>dynamic accuracy table</u>

<b>Third Order Intercept<sup>g</sup> - Tone spacing from 100 kHz - 5 MHz</b>			
	<b>Standard</b>	<b>Option 014</b>	
			<b>typical</b>
10 MHz to 500 MHz			+30 dBm
500 MHz to 24 GHz			+24 dBm
24 GHz to 40 GHz			+23 dBm
40 to 50 GHz			+24 dBm
50 to 67 GHz			+26 dBm
<b>Third Order Intercept<sup>g</sup> - Tone spacing from 5 MHz - 20 MHz</b>			
	<b>Standard</b>	<b>Option 014</b>	
			<b>typical</b>
10 MHz to 500 MHz			NA
500 MHz to 24 GHz			+20 dBm
24 GHz to 40 GHz			+20 dBm
40 to 50 GHz			+22 dBm
50 to 67 GHz			+24 dBm
<b>Third Order Intercept<sup>g</sup> - Tone spacing from 20 MHz - 50 MHz</b>			
	<b>Standard</b>	<b>Option 014</b>	
			<b>typical</b>
10 MHz to 500 MHz			NA
500 MHz to 24 GHz			+26 dBm
24 to 40 GHz			+24 dBm
40 to 50 GHz			+25 dBm
50 to 67 GHz			+27 dBm
<b>Trace Noise Magnitude</b>			
1 kHz IF bandwidth. Ratio measurement, nominal power at test port.			
	<b>Standard</b>	<b>Option 014</b>	
10 MHz to 45 MHz <sup>b</sup>	<0.100 dB rms		
45 MHz to 500 MHz <sup>e</sup>	<0.010 dB rms		
500 MHz to 24 GHz	<0.006 dB rms		
24 GHz to 67 GHz	<0.006 dB rms		
67 GHz to 70 GHz <sup>b</sup>	<0.006 dB rms		

<b>Trace Noise Magnitude - Option 080 enabled<sup>b,d</sup></b>			
1 kHz IF bandwidth. Ratio measurement, nominal power at test port.			
	<b>Standard</b>	<b>Option 014</b>	
			<b>typical:</b>
10 MHz to 45 MHz			<0.100 dB rms
45 MHz to 500 MHz <sup>e</sup>			<0.010 dB rms
500 MHz to 24 GHz			<0.006 dB rms
24 GHz to 67 GHz			<0.009 dB rms
67 GHz to 70 GHz			<0.009 dB rms
<b>Trace Noise Phase</b>			
1 kHz IF bandwidth. Ratio measurement, nominal power at test port.			
	<b>Standard</b>	<b>Option 014</b>	
10 MHz to 45 MHz <sup>b</sup>	<0.500° rms		
45 MHz to 500 MHz	<0.100° rms		
500 MHz to 24 GHz	<0.060° rms		
24 GHz to 67 GHz	<0.100° rms		
67 GHz to 70 GHz <sup>b</sup>	<0.100° rms		
<b>Trace Noise Phase - Option 080 enabled<sup>b,d</sup></b>			
1 kHz IF bandwidth. Ratio measurement, nominal power at test port.			
	<b>Standard</b>	<b>Option 014</b>	
			<b>typical:</b>
10 MHz to 45 MHz			<0.500° rms
45 MHz to 500 MHz			<0.100° rms
500 MHz to 24 GHz			<0.060° rms
24 GHz to 67 GHz			<0.100° rms
67 GHz to 70 GHz			<0.100° rms
<b>Reference Level Magnitude</b>			
Range	+/-500 dB		
Resolution	0.001 dB		

Reference Level Phase			
Range	+/-500°		
Resolution	0.01°		
Stability Magnitude			
	Standard	Option 014	
Typical ratio measurement, made at the test port.			
10 MHz to 20 GHz			+/-0.01 dB/°C
20 GHz to 70 GHz			+/-0.02 dB/°C
Stability Phase <sup>f</sup>			
	Standard	Option 014	
Typical ratio measurement, measured at the test port.			
10 MHz to 20 GHz			+/-0.2°/°C
20 GHz to 40 GHz			+/-0.5°/°C
40 GHz to 70 GHz			+/-0.8°/°C
Damage Input Level			
	Standard	Option 014	
			<b>typical:</b>
Test Port 1 and 2			+27 dBm or +/-40 VDC
R1, R2 in			+15 dBm or +/-15 VDC
A, B in			+15 dBm or +/-15 VDC
Coupler Thru (Option 014)			+27 dBm or +/-40 VDC
Coupler Arm (Option 014)			+30 dBm or +/-7 VDC

<sup>a</sup>Total average (rms) noise power calculated as the mean value of a linear magnitude trace expressed in dBm.

<sup>b</sup>Typical performance.

<sup>c</sup>Noise floor may be degraded by 10 dB at particular frequencies (multiples of 5 MHz) due to spurious receiver residuals.

<sup>d</sup>0 Hz offset

<sup>e</sup>Trace noise magnitude may be degraded to 20 mB rms at harmonic frequencies of the first IF (8.33 MHz) below 80 MHz.

<sup>f</sup>Stability is defined as a ratio measurement made at the test port.

<sup>g</sup>TOI is a typical specification that applies while the network analyzer receiver is in its linear range.

<sup>h</sup>Coupler roll-off will reduce compression to a negligible level below 500 MHz.

**Table 35. Dynamic Accuracy (Specification<sup>a</sup>)**

Accuracy of the test port input power reading relative to the reference input power level.

### Magnitude

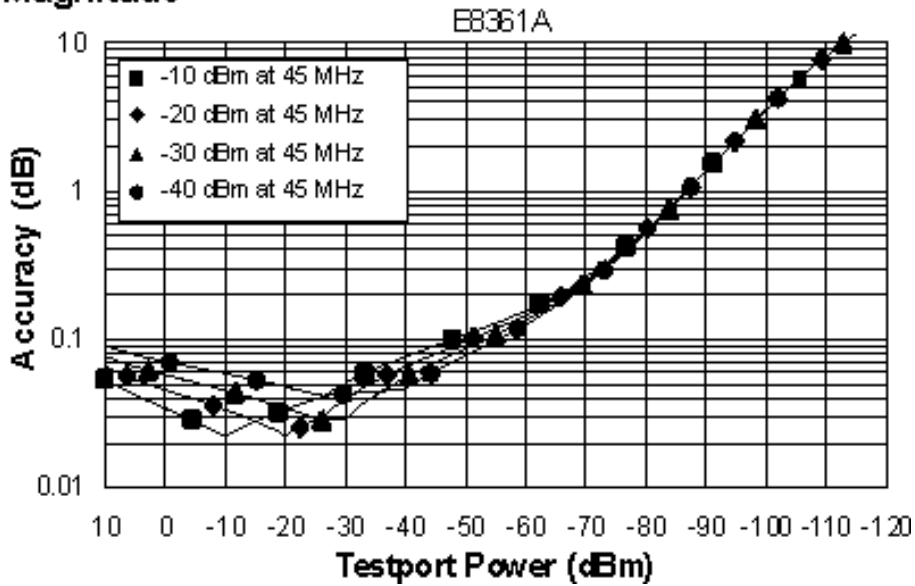

### Phase

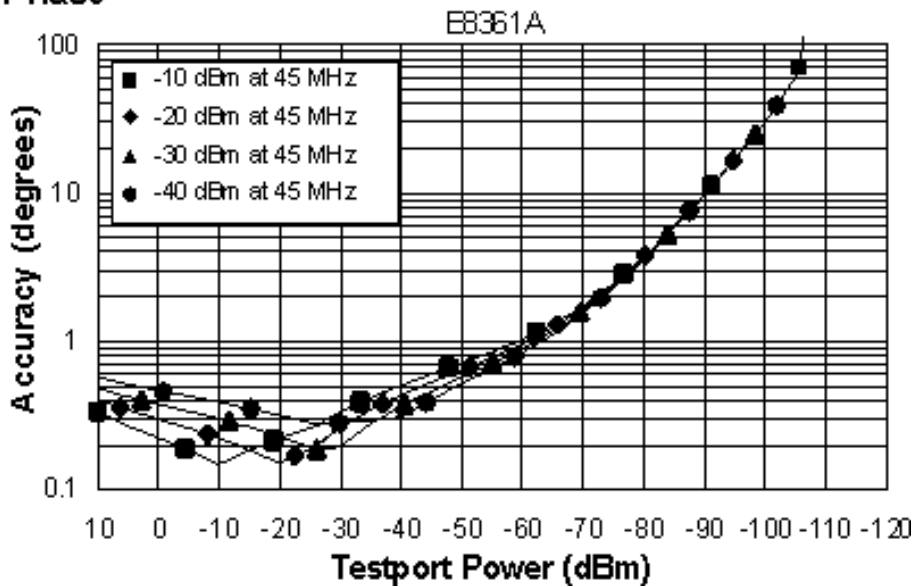



## Magnitude

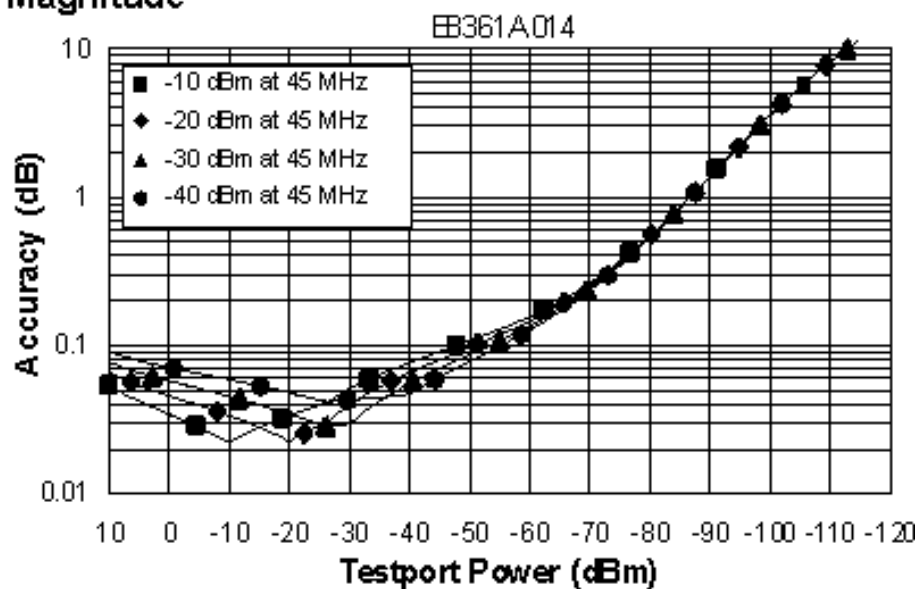

## Phase

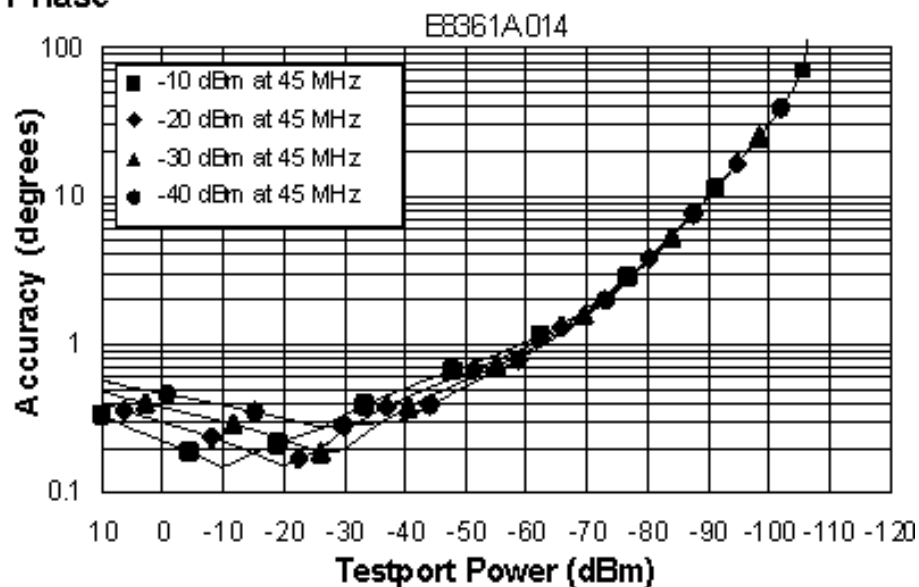

## Magnitude

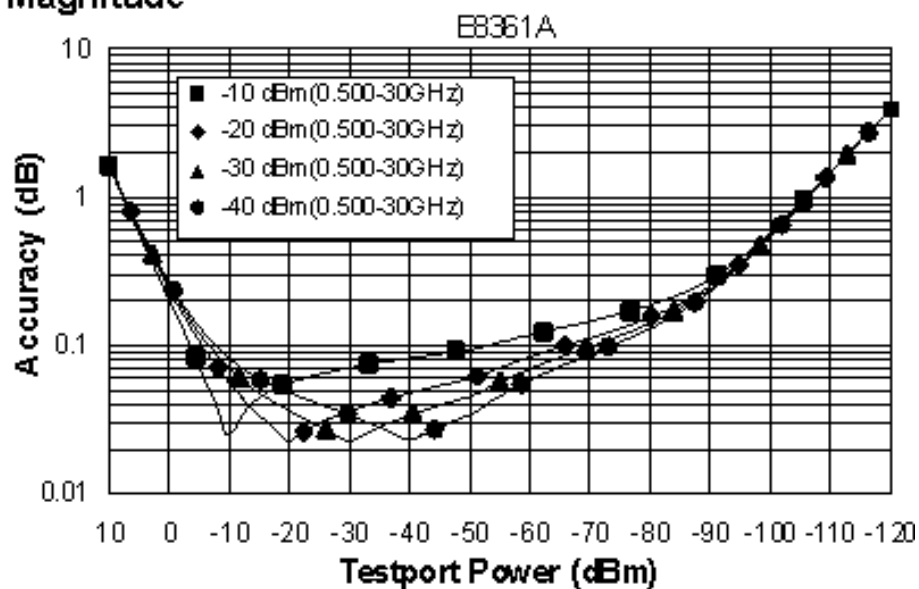

## Phase

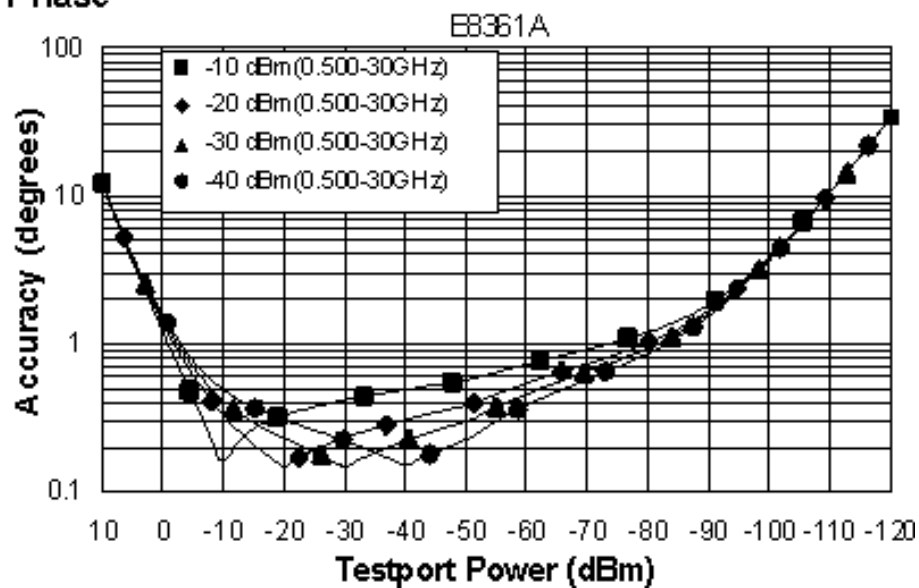

## Magnitude

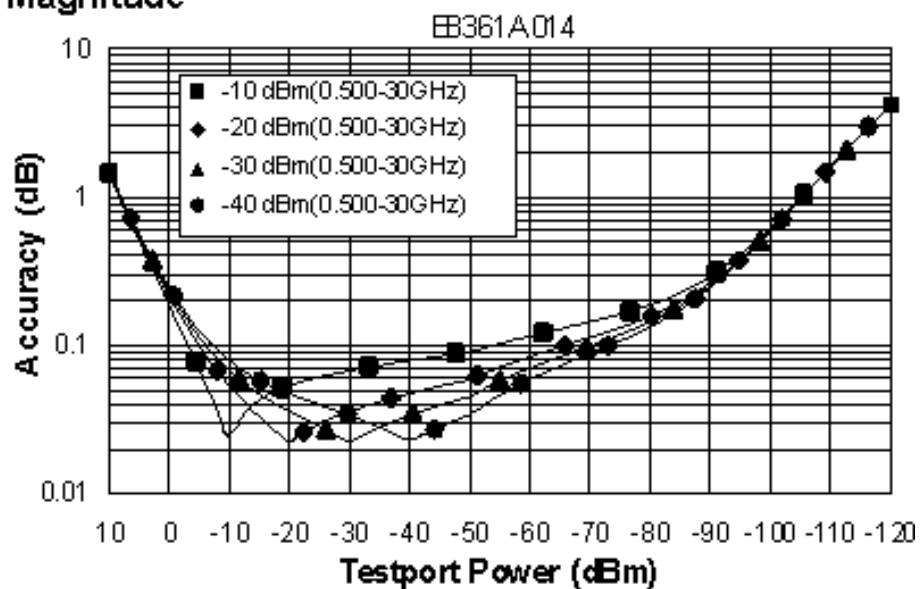

## Phase

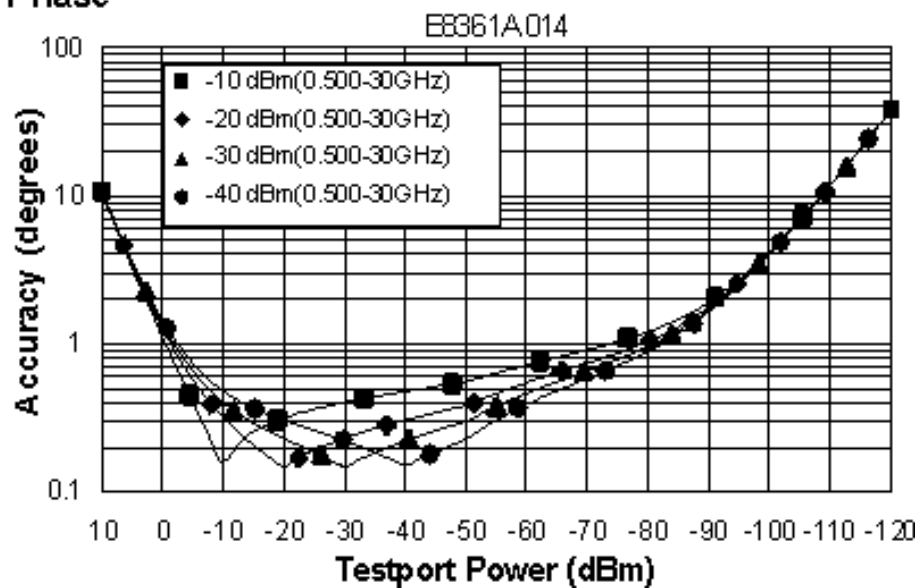

## Magnitude

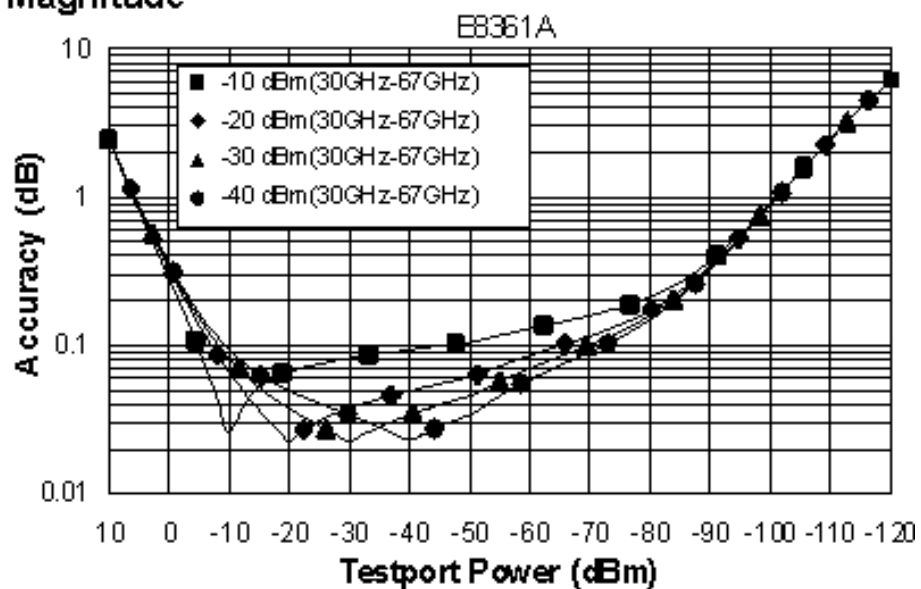

## Phase

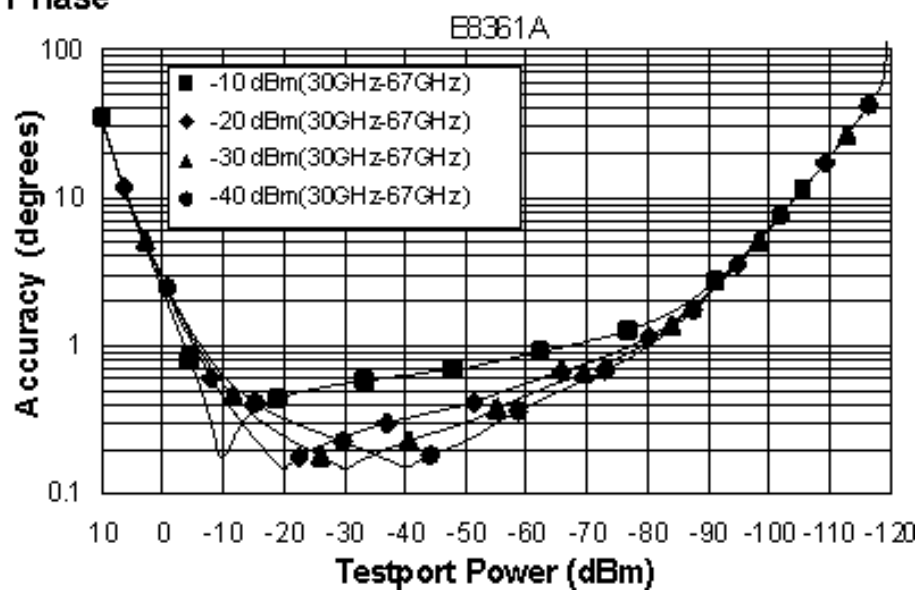

## Magnitude

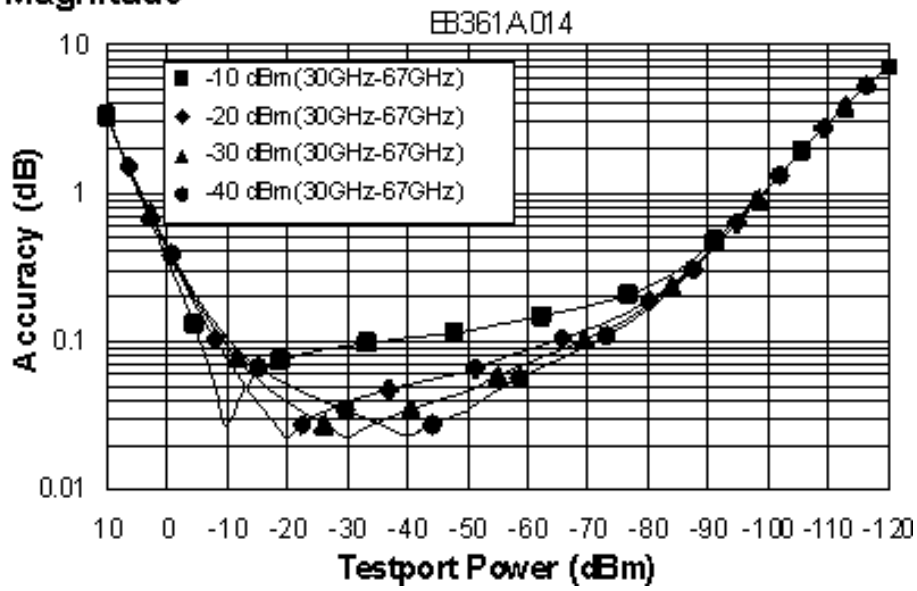

## Phase

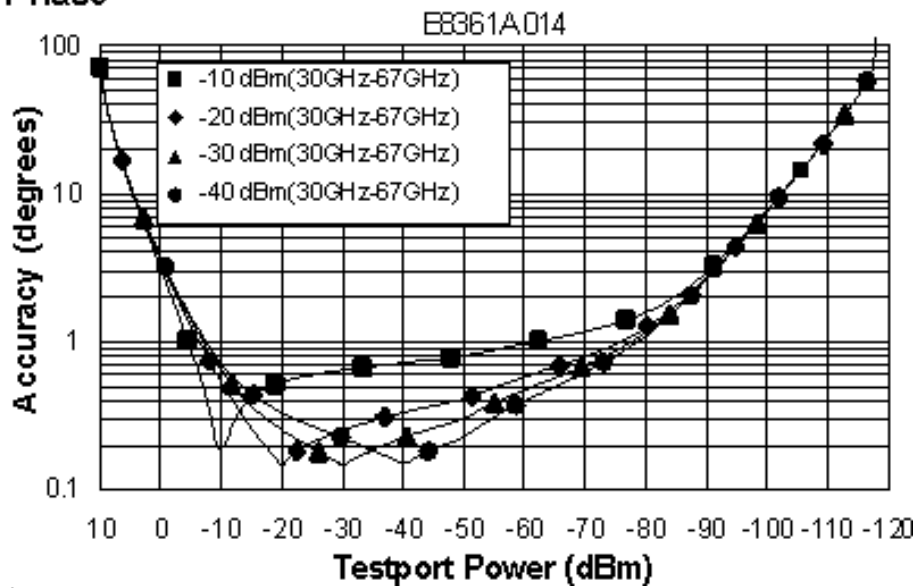

<sup>a</sup> Dynamic accuracy is verified with the following measurements:

- compression over frequency
- IF linearity at a single frequency of 1.195 GHz and a reference level of -20 dBm

**Table 36. Test Port Input (Group Delay)<sup>a</sup>**

Description	Specification	Supplemental Information
Aperture (selectable)	(frequency span)/(number of points -1)	
Maximum Aperture	20% of frequency span	
Range	0.5 x (1/minimum aperture)	
Maximum Delay		Limited to measuring no more than 180° of phase change within the minimum aperture.)
Accuracy		See graph below. Char.

The following graph shows characteristic group delay accuracy with full 2-port calibration and a 10 Hz IF bandwidth. Insertion loss is assumed to be < 2 dB and electrical length to be ten meters.

**Group Delay (Typical)**

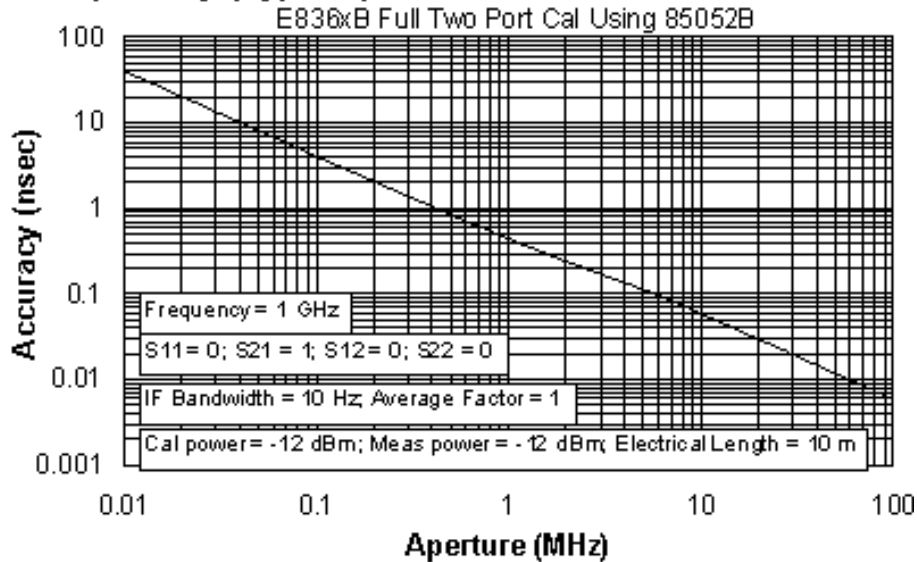

In general, the following formula can be used to determine the accuracy, in seconds, of specific group delay measurement:

$$\pm \text{Phase Accuracy (deg)} / [360 \times \text{Aperture (Hz)}]$$

Depending on the aperture and device length, the phase accuracy used is either incremental phase accuracy or worst case phase accuracy.

<sup>a</sup> Group delay is computed by measuring the phase change within a specified frequency step (determined by the frequency span and the number of points per sweep).

**General Information**

**Table 37. Miscellaneous Information**

Description	Specification	Supplemental Information
System IF Bandwidth Range		1 Hz to 40 kHz, nominal
CPU		Intel® 500 MHz Pentium® III

**Table 38. Front Panel Information**

Description	Supplemental Information
<b>RF Connectors</b>	
<b>E8361A</b>	
Type	1.85 mm (male), 50 ohm, (nominal)
Center Pin Recession	0.002 in. (characteristic)
<b>Display</b>	
Size	21.3 cm (8.4 in) diagonal color active matrix LCD; 640 (horizontal) X 480 (vertical) resolution
Refresh Rate	Vertical 59.83 Hz; Horizontal 31.41 Hz

<b>Display Range</b>	
Magnitude	±500 dB (at 20 dB/div), max
Phase	±500°, max
Polar	10 pUnits, min 1000 Units, max
<b>Display Resolution</b>	
Magnitude	0.001 dB/div, min
Phase	0.01°/div, min
<b>Marker Resolution</b>	
Magnitude	0.001 dB, min
Phase	0.01°, min
Polar	0.01 mUnit, min; 0.01°, min

**Table 39. Rear Panel Information**

<b>Description</b>	<b>Supplemental Information</b>
<b>10 MHz Reference In</b>	
Connector	BNC, female
Input Frequency	10 MHz ± 10 ppm, typical
Input Level	-15 dBm to +20 dBm, typical
Input Impedance	200 Ω, nom.
<b>10 MHz Reference Out</b>	
Connector	BNC, female
Output Frequency	10 MHz ± 1 ppm, typical
Signal Type	Sine Wave, typical
Output Level	+10 dBm ± 4 dB into 50 Ω, typical
Output Impedance	50 Ω, nominal
Harmonics	<-40 dBc, typical
<b>VGA Video Output</b>	
Connector	15-pin mini D-Sub; Drives VGA compatible monitors
Devices Supported:	
	<b>Resolutions:</b>
Flat Panel (TFT)	1024 X 768, 800 X 600, 640 X 480
Flat Panel (DSTN)	800 X 600, 640 X 480
CRT Monitor	1280 X 1024, 1024 X 768, 800 X 600, 640 X 480
	Simultaneous operation of the internal and external displays is allowed, but with 640 X 480 resolution only. If you change resolution, you can only view the external display (internal display will "white out").
<b>Test Set IO</b>	
	25-pin D-Sub connector, available for external test set control
<b>Aux IO</b>	
	25-pin D-Sub connector, male, analog and digital IO
<b>Handler IO</b>	
	36-pin parallel I/O port; all input/output signals are default set to negative logic; can be reset to positive logic via GPIB command
<b>GPIB</b>	
	24-pin D-sub (Type D-24), female; compatible with IEEE-488.
<b>Parallel Port (LPT1)</b>	
	25-pin D-Sub miniature connector, female; provides connection to printers or any other parallel port peripherals
<b>Serial Port (COM 1)</b>	
	9-pin D-Sub, male; compatible with RS-232

USB Port	
	One port on front panel and five ports on rear panel. Universal Serial Bus jack, Type A configuration (4 contacts inline, contact 1 on left); female
Contact 1	Vcc: 4.75 to 5.25 VDC, 500 mA, maximum
Contact 2	-Data
Contact 3	+Data
Contact 4	Ground
LAN	
	10/100BaseT Ethernet, 8-pin configuration; auto selects between the two data rates
Line Power <sup>a</sup>	
Frequency	48 Hz to 66 Hz
Voltage at 115 V Setting	90 to 132 VAC; 120 VAC, nominal
Voltage at 220 V Setting	198 to 264 VAC; 240 VAC, nominal
VA Max	600 VA maximum

<sup>a</sup> A third-wire ground is required.

**Table 40. Analyzer Environment and Dimensions**

Description	Supplemental Information		
General Environmental			
RFI/EMI Susceptibility	Defined by CISPR Pub. 11, Group 1, Class A, and IEC 50082-1		
ESD	Minimize using static-safe work procedures and an antistatic bench mat		
Dust	Minimize for optimum reliability		
Operating Environment			
Temperature	0 °C to +40 °C Instrument powers up, phase locks, and displays no error messages within this temperature range (except for "source unlevelled" error message that may occur at temperatures outside the specified performance temperature range of 25 +/- 5°C).		
Error-Corrected Temperature Range	23°C ± 3°C with less than 1°C deviation from calibration temp.		
Humidity	5% to 95% at +40 °C		
Altitude	0 to 4500 m (14,760 ft.)		
Non-Operating Storage Environment			
Temperature	-40 °C to +70 °C		
Humidity	0% to 90% at +65 °C (non-condensing)		
Altitude	0 to 15,240 m (50,000 ft.)		
Cabinet Dimensions			
	Height	Width	Depth
Excluding front and rear panel hardware and feet	222 mm 8.75 in	425 mm 16.75 in	426 mm 16.8 in
As shipped - includes front panel connectors, rear panel bumpers, and feet.	242 mm 9.5 in	425 mm 16.75 in	472 mm 18.6 in
As shipped plus handles	242 mm 9.5 in	458 mm 18 in	453 mm 17.8 in
As shipped plus rack-mount flanges	242 mm 9.5 in	483 mm 19 in	472 mm 18.6 in
As shipped plus handles and rack-mount flanges	242 mm 9.5 in	483 mm 19 in	453 mm 17.8 in



<b>Weight</b>	
<b>Net</b>	
E8361A	29 kg (64 lb), nominal
<b>Shipping</b>	
E8361A	36.3 kg (80 lb), nominal

## Measurement Throughput Summary

**Table 41** Typical Cycle Time<sup>a,b</sup> (ms) for Measurement Completion

	Number of Points			
	201	401	1601	16,001
<b>Start 28 GHz, Stop 30 GHz, 35 kHz IF bandwidth</b>				
Uncorrected, 1-port cal	12	19	55	503
2-Port cal	29	44	124	1112
<b>Start 10 MHz, Stop 10 GHz, 35 kHz IF bandwidth</b>				
Uncorrected, 1-port cal	86	93	121	583
2-Port cal	179	199	267	1301
<b>Start 10 MHz, Stop 20 GHz, 35 kHz IF bandwidth</b>				
Uncorrected, 1-port cal	126	130	153	597
2-Port cal	264	275	335	1321
<b>Start 10 MHz, Stop 40 GHz, 35 kHz IF bandwidth</b>				
Uncorrected, 1-port cal	185	190	213	621
2-Port cal	382	401	459	1374
<b>Start 10 MHz, Stop 50 GHz, 35 kHz IF bandwidth</b>				
Uncorrected, 1-port cal	210	216	243	643
2-Port cal	436	450	522	1405
<b>Start 10 MHz, Stop 67 GHz, 35 kHz IF bandwidth</b>				
Uncorrected	244	254	300	645
Corrected	502	524	591	1423

<sup>a</sup> Typical performance.

<sup>b</sup> Includes sweep time, retrace time and band-crossing time. Analyzer display turned off with DISPLAY:ENABLE OFF. Add 21 ms for display on. Data for one trace (S11) measurement.

**Table 42. Cycle Time vs IF Bandwidth<sup>a</sup>**

Applies to the Preset condition (201 points, correction off) except for the following changes:

- CF = 28 GHz
- Span = 100 MHz
- Display off (add 21 ms for display on)

IF Bandwidth (Hz)	Cycle Time (ms) <sup>b</sup>	Cycle Time (ms) Option 080 enabled
40,000	11	100
35,000	12	101
30,000	13	102
20,000	16	106
10,000	30	127
7000	38	138
5000	50	152
3000	74	182
1000	274	326
300	694	782
100	1905	2054
30	6091	6355
10	17916	18372

<sup>a</sup> Typical performance.

<sup>b</sup> Cycle time includes sweep and retrace time.

**Table 43. Cycle Time vs Number of Points<sup>a</sup>**

Applies to the Preset condition (35 kHz IF bandwidth, correction off) except for the following changes:

- CF = 28 GHz
- Span = 100 MHz
- Display off (add 21 ms for display on)

Number of Points	Cycle Time (ms) <sup>b</sup>
3	6
11	6
51	7
101	9
201	12
401	18
801	30
1601	55
16,001	497

<sup>a</sup> Typical performance.

<sup>b</sup> Cycle time includes sweep and retrace time.

**Table 44.** Data Transfer Time (ms)<sup>a</sup>

	Number of Points			
	201	401	1601	16,001
<b>SCPI over GPIB</b>				
<b>(program executed on external PC)</b>				
32-bit floating point	7	12	43	435
64-bit floating point	12	22	84	856
ASCII	64	124	489	5054
<b>SCPI</b>				
<b>(program executed in the analyzer)</b>				
32-bit floating point	1	2	3	30
64-bit floating point	2	2	4	40
ASCII	29	56	222	2220
<b>COM (program executed in the analyzer)</b>				
32-bit floating point	1	1	1	6
Variant type	1	2	6	68
<b>DCOM over LAN</b>				
<b>(program executed on external PC)</b>				
32-bit floating point	1	1	2	121
Variant type	3	6	19	939

<sup>a</sup> Typical performance

**Note:** Specifications for Recall & Sweep Speed are not provided for the E8361A analyzers.

## Specifications: Front-Panel Jumpers

### Model E8361A Option 014

**NOTE:** The standard E8361A has no front-panel jumpers.

**Table 45:** Measurement Receiver Inputs (Rcvr A In, Rcvr B In)

Description	Specification	Supplemental Information
<b>Maximum Input Level</b>		
<b>E8361A:</b>		
		<b>typical:</b>
10 MHz to 45 MHz		- 20 dBm
45 MHz to 500 MHz		- 18 dBm
500 MHz to 2 GHz		- 13.5 dBm
2 GHz to 10 GHz		- 13 dBm
10 GHz to 24 GHz		- 13 dBm
24 GHz to 30 GHz		- 13.5 dBm
30 GHz to 40 GHz		- 15 dBm
40 GHz to 45 GHz		- 19 dBm
45 GHz to 50 GHz		- 14.5 dBm
50 GHz to 60 GHz		- 16 dBm
60 GHz to 67 GHz		- 18 dBm
67 GHz to 70 GHz		- 17 dBm
<b>Damage Level</b>		
E8361A		+ 15 dBm
<b>Maximum DC Level</b>		
E8361A		+ 15 V

**Table 46: Reference Receiver Inputs (Rcvr R1, Rcvr R2)**

Description	Specification	Supplemental Information
<b>Maximum Input Level</b>		
<b>E8361A:</b>		
		<b>typical:</b>
10 MHz to 45 MHz		- 20 dBm
45 MHz to 500 MHz		- 17.5 dBm
500 MHz to 2 GHz		- 12.5 dBm
2 GHz to 10 GHz		- 10.5 dBm
10 GHz to 24 GHz		- 10 dBm
24 GHz to 30 GHz		- 9 dBm
30 GHz to 40 GHz		- 10 dBm
40 GHz to 45 GHz		- 13.5 dBm
45 GHz to 50 GHz		- 8.5 dBm
50 GHz to 60 GHz		- 9.5 dBm
60 GHz to 67 GHz		- 11 dBm
67 GHz to 70 GHz		- 9.5 dBm
<b>Damage Level</b>		
E8361A		+ 15 dBm
<b>Maximum DC Level</b>		
E8361A		+/- 15 V

**Table 47: Reference Outputs (Reference 1 Source Out, Reference 2 Source Out)**

Description	Specification	Supplemental Information
<b>Maximum Output Level</b>		
<b>E8361A:</b>		
		<b>typical:</b>
10 MHz to 45 MHz		- 43 dBm
45 MHz to 500 MHz		- 17.5 dBm
500 MHz to 2 GHz		- 12.5 dBm
2 GHz to 10 GHz		- 10.5 dBm
10 GHz to 24 GHz		- 9.5 dBm
24 GHz to 30 GHz		- 9 dBm
30 GHz to 40 GHz		- 9.5 dBm
40 GHz to 45 GHz		- 13 dBm
45 GHz to 50 GHz		- 8.5 dBm
50 GHz to 60 GHz		- 9 dBm
60 GHz to 67 GHz		- 10.5 dBm
67 GHz to 70 GHz		- 9 dBm
<b>Damage Level</b>		
E8361A		+ 20 dBm
<b>Maximum DC Level</b>		
E8361A		+/- 15 V

**Table 48: Source Outputs (Port 1 Source Out, Port 2 Source Out)**

Description	Specification	Supplemental Information
<b>Maximum Output Level</b>		
<b>E8361A</b>		
		<b>typical:</b>
10 MHz to 45 MHz		-6.5 dBm
45 MHz to 500 MHz		-2.5 dBm
500 MHz to 2 GHz		-1 dBm
2 GHz to 10 GHz		-1.5 dBm
10 GHz to 24 GHz		-2 dBm
24 GHz to 30 GHz		-3 dBm
30 GHz to 40 GHz		-1 dBm
40 GHz to 45 GHz		-2.5 dBm
45 GHz to 50 GHz		-2 dBm
50 GHz to 60 GHz		0 dBm
60 GHz to 67 GHz		-2 dBm
67 GHz to 70 GHz		-0.5 dBm
<b>Damage Level</b>		
E8361A		27 dBm
<b>Maximum DC Level</b>		
E8361A		+/- 40 V

**Table 49: Coupler Inputs (Port 1 Cplr Thru, Port 2 Cplr Thru)**

Description	Specification	Supplemental Information
<b>Insertion Loss to Test Port</b>		
<b>E8361A</b>		
		<b>typical:</b>
10 MHz to 45 MHz		0.5 dB
45 MHz to 500 MHz		0.5 dB
500 MHz to 2 GHz		0.5 dB
2 GHz to 10 GHz		1.5 dB
10 GHz to 24 GHz		2 dB
24 GHz to 30 GHz		2.5 dB
30 GHz to 40 GHz		3 dB
40 GHz to 45 GHz		3 dB
45 GHz to 50 GHz		3.5 dB
50 GHz to 60 GHz		4 dB
60 GHz to 67 GHz		4.5 dB
67 GHz to 70 GHz		6 dB
<b>Damage Level</b>		
E8361A		+ 27 dBm
<b>Maximum DC Level</b>		
E8361A		+/- 40 V

**Table 50: Coupler Outputs (Port 1 Cplr Arm, Port 2 Cplr Arm)**

Description	Specification	Supplemental Information
<b>Damage Level</b>		
E8361A		+ 30 dBm
<b>Maximum DC Level</b>		
E8361A		+/- 7 V

Test Set Block Diagrams

E8361A - Standard Configuration and Standard Power Range

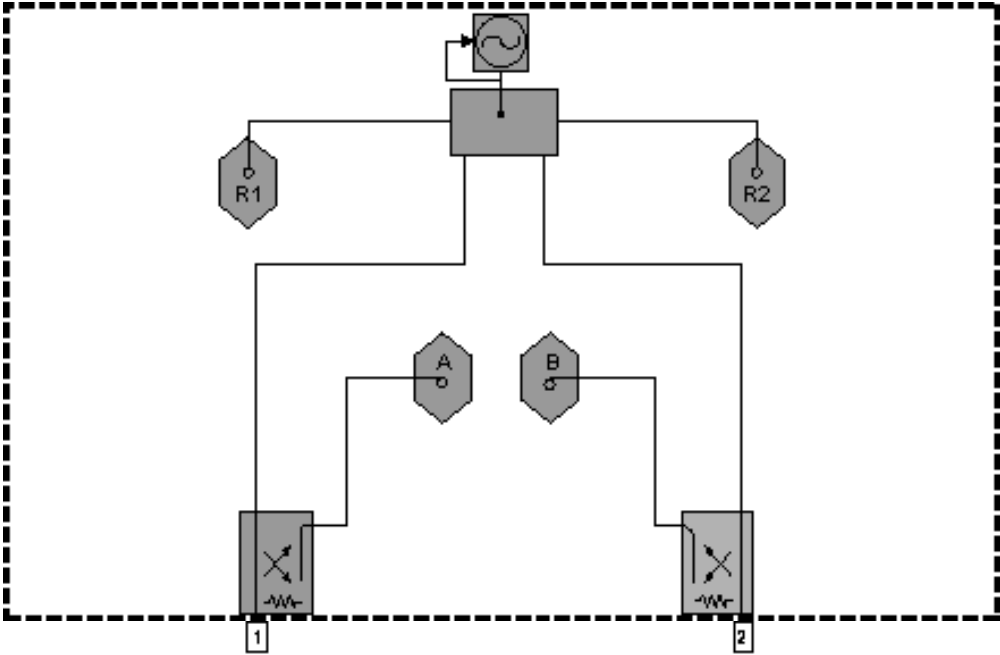

## Test Set with Option 014 Block Diagrams

### E8361A - Option 014 Configurable Test Set and Standard Power Range

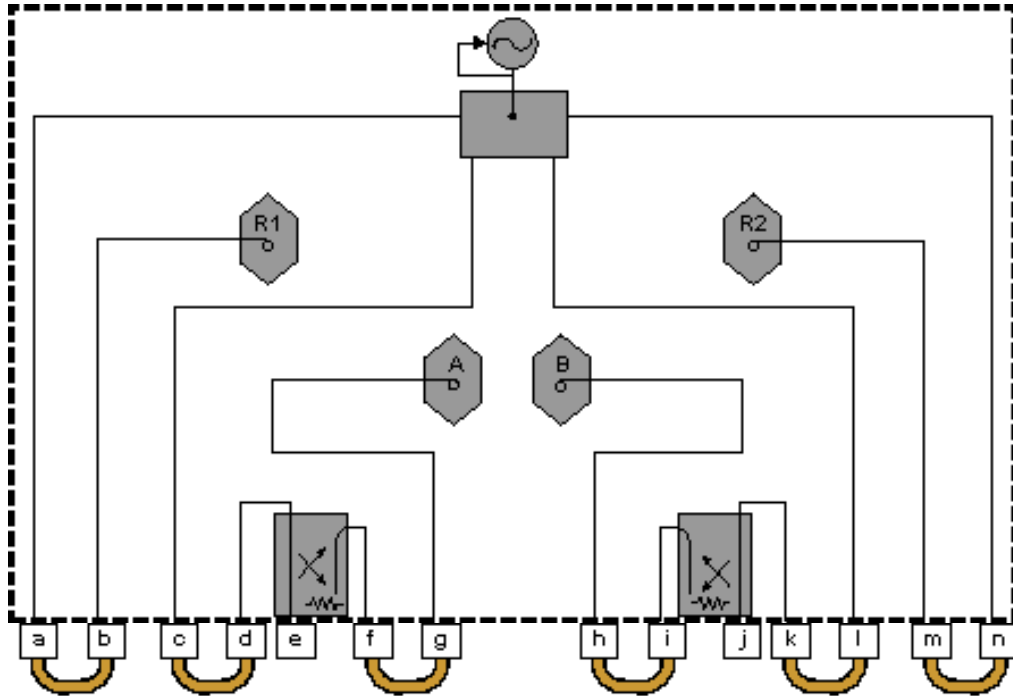

Item	Description	Item	Description
a	SOURCE OUT	h	RCVR B IN
b	RCVR R1 IN	i	CPLR ARM
c	SOURCE OUT	j	PORT 2
d	CPLR THRU	k	CPLR THRU
e	PORT 1	l	SOURCE OUT
f	CPLR ARM	m	RCVR R2 IN
g	RCVR A IN	n	SOURCE OUT





## 7 Equations Used to Generate Uncertainty Curves

Measurement Uncertainty Equations.....	7-2
Forward Reflection Uncertainty .....	7-2
Forward Transmission Uncertainty.....	7-3
Reverse Reflection Uncertainty .....	7-4
Reverse Transmission Uncertainty .....	7-4
Sources of Systematic Errors .....	7-5
Sources of Random Errors .....	7-5
Determining Expected System Performance .....	7-6
Determining Cable Stability Terms ( $C_{R1}$ , $C_{R2}$ , $C_{TM1}$ , $C_{TM2}$ , $C_{TP1}$ , $C_{TP2}$ ) .....	7-6

---

This topic contains the measurement uncertainty equations used to generate the uncertainty curves in the Specifications document. It also contains general information about determining system measurement uncertainties.

Learn about the following subjects:

- Measurement Uncertainty Equations
  - Forward Reflection Uncertainty
  - Forward Transmission Uncertainty
  - Reverse Reflection Uncertainty
  - Reverse Transmission Uncertainty
- Sources of Systematic Errors
- Sources of Random Errors
- Determining Expected System Performance
- Determining Cable Stability Terms ( $C_{R1}$ ,  $C_{R2}$ ,  $C_{TM1}$ ,  $C_{TM2}$ ,  $C_{TP1}$ ,  $C_{TP2}$ )
- Measurement Errors
- What is Measurement Calibration?
- Why is Calibration Necessary?

---

## Measurement Uncertainty Equations

Any measurement result is the vector sum of the actual test device response plus all error terms. The precise effect of each error term depends on its magnitude and phase relationship to the actual test device response. When the phase of an error response is not known, phase is assumed to be worst case (-180° to +180°).

View the abbreviations for residual systematic errors used in the equations.

View the abbreviations for random errors used in the error models and equations.

### Forward Reflection Uncertainty

#### Equation 1: Forward Reflection Magnitude Uncertainty

$$\Delta S_{11(\text{mag})} = \sqrt{(\text{Systematic} + \text{Stability})^2 + \text{Noise}^2}$$

#### Where:

$$\text{Systematic} = E_{DF} + E_{RF}S_{11} + E_{SF}S_{11}^2 + E_{LF}S_{21}S_{12} + A_M S_{11}$$

$$\text{Stability} = \sqrt{C^2 + R^2}$$

$$C^2 = C_{RM1}^2(1 + S_{11}^A) + 4C_{TM1}^2 S_{11}^2 + C_{RM2}^2 S_{21}^2 S_{12}^2$$

$$R^2 = (R_{R1}(1 + S_{11}^2) + 2R_{T1}S_{11})^2 + (R_{R2}S_{21}S_{12})^2$$

$$\text{Noise}^2 = (N_T S_{11})^2 + N_F^2$$

## Equation 2: Forward Reflection Phase Uncertainty

$$\Delta S_{11(\text{phase})} = \sin^{-1} \left( \frac{\sqrt{(\text{Systematic} + \text{Stability})^2 + \text{Noise}^2}}{S_{11}} \right) + 2C_{TP1}$$

**Where:**

$$\text{Systematic} = E_{DF} + E_{RF}S_{11} + E_{SF}S_{11}^2 + E_{LF}S_{21}S_{12} + \sin(A_p)S_{11}$$

$$\text{Stability} = \sqrt{C^2 + R^2}$$

$$C^2 = C_{RM1}^2(1 + S_{11}^4) + 4C_{TM1}^2S_{11}^2 + C_{RM2}^2S_{21}^2S_{12}^2$$

$$R^2 = (R_{R1}(1 + S_{11}^2) + 2R_{T1}S_{11})^2 + (R_{R2}S_{21}S_{12})^2$$

$$\text{Noise}^2 = (N_T S_{11})^2 + N_F^2$$

## Forward Transmission Uncertainty

### Equation 3: Forward Transmission Magnitude Uncertainty

$$\Delta S_{21(\text{mag})} = \sqrt{(\text{Systematic} + \text{Stability})^2 + \text{Noise}^2}$$

**Where:**

$$\text{Systematic} = E_{XF} + S_{21}(E_{TF} + E_{SF}S_{11} + E_{LF}S_{22} + E_{SF}E_{LF}S_{21}S_{12} + A_M)$$

$$\text{Stability} = \sqrt{C^2 + R^2}$$

$$C^2 = S_{21}^2(C_{TM1}^2 + C_{TM2}^2 + (C_{R1}S_{11})^2 + (C_{R2}S_{22})^2)$$

$$R^2 = S_{21}^2((R_{T1} + R_{R1}S_{11})^2 + (R_{T2} + R_{R2}S_{22})^2)$$

$$\text{Noise}^2 = (N_T S_{21})^2 + N_F^2$$

### Equation 4: Forward Transmission Phase Uncertainty

$$\Delta S_{21(\text{phase})} = \sin^{-1} \left( \frac{\sqrt{(\text{Systematic} + \text{Stability})^2 + \text{Noise}^2}}{S_{21}} \right) + C_{TP1} + C_{TP2}$$

**Where:**

$$\text{Systematic} = E_{XF} + S_{21}(E_{TF} + E_{SF}S_{11} + E_{LF}S_{22} + E_{SF}E_{LF}S_{21}S_{12} + \sin(A_p))$$

$$\text{Stability} = \sqrt{C^2 + R^2}$$

$$C^2 = S_{21}^2(C_{TM1}^2 + C_{TM2}^2 + (C_{R1}S_{11})^2 + (C_{R2}S_{22})^2)$$

$$R^2 = S_{21}^2((R_{T1} + R_{R1}S_{11})^2 + (R_{T2} + R_{R2}S_{22})^2)$$

$$\text{Noise}^2 = (N_T S_{21})^2 + N_F^2$$

## Reverse Reflection Uncertainty

### Equation 5: Reverse Reflection Magnitude Uncertainty

$$\Delta S_{22(\text{mag})} = \sqrt{(\text{Systematic} + \text{Stability})^2 + \text{Noise}^2}$$

**Where:**

$$\text{Systematic} = E_{DR} + E_{RR}S_{22} + E_{SR}S_{22}^2 + E_{LR}S_{21}S_{12} + A_M S_{22}$$

$$\text{Stability} = \sqrt{C^2 + R^2}$$

$$C^2 = C_{RM2}^2(1 + S_{22}^4) + 4C_{TM2}^2S_{22}^2 + C_{RM1}^2S_{21}^2S_{12}^2$$

$$R^2 = (R_{R2}(1 + S_{22}^2) + 2R_{T2}S_{22})^2 + (R_{R1}S_{21}S_{12})^2$$

$$\text{Noise}^2 = (N_T S_{22})^2 + N_F^2$$

### Equation 6: Reverse Reflection Phase Uncertainty

$$\Delta S_{22(\text{phase})} = \sin^{-1}\left(\frac{\sqrt{(\text{Systematic} + \text{Stability})^2 + \text{Noise}^2}}{S_{22}}\right) + 2C_{TF2}$$

**Where:**

$$\text{Systematic} = E_{DR} + E_{RR}S_{22} + E_{SR}S_{22}^2 + E_{LR}S_{21}S_{12} + \sin(A_P)S_{22}$$

$$\text{Stability} = \sqrt{C^2 + R^2}$$

$$C^2 = C_{RM2}^2(1 + S_{22}^4) + 4C_{TM2}^2S_{22}^2 + C_{RM1}^2S_{21}^2S_{12}^2$$

$$R^2 = (R_{R2}(1 + S_{22}^2) + 2R_{T2}S_{22})^2 + (R_{R1}S_{21}S_{12})^2$$

$$\text{Noise}^2 = (N_T S_{22})^2 + N_F^2$$

## Reverse Transmission Uncertainty

### Equation 7: Reverse Transmission Magnitude Uncertainty

$$\Delta S_{12(\text{mag})} = \sqrt{(\text{Systematic} + \text{Stability})^2 + \text{Noise}^2}$$

**Where:**

$$\text{Systematic} = E_{XR} + S_{12}(E_{TR} + E_{SR}S_{22} + E_{LR}S_{11} + E_{SR}E_{LR}S_{21}S_{12} + A_M)$$

$$\text{Stability} = \sqrt{C^2 + R^2}$$

$$C^2 = S_{12}^2(C_{TM1}^2 + C_{TM2}^2 + (C_{R1}S_{11})^2 + (C_{R2}S_{22})^2)$$

$$R^2 = S_{12}^2((R_{T1} + R_{R1}S_{11})^2 + (R_{T2} + R_{R2}S_{22})^2)$$

$$\text{Noise}^2 = (N_T S_{12})^2 + N_F^2$$

## Equation 8: Reverse Transmission Phase Uncertainty

$$\Delta S_{12(\text{phase})} = \sin^{-1} \left( \frac{\sqrt{(\text{Systematic} + \text{Stability})^2 + \text{Noise}^2}}{S_{12}} \right) + C_{TP1} + C_{TP2}$$

### Where:

$$\text{Systematic} = E_{XR} + S_{12}(E_{TR} + E_{SR}S_{22} + E_{LR}S_{11} + E_{SR}E_{LR}S_{21}S_{12} + \sin(A_p))$$

$$\text{Stability} = \sqrt{C^2 + R^2}$$

$$C^2 = S_{12}^2(C_{TM1}^2 + C_{TM2}^2 + (C_{R1}S_{11})^2 + (C_{R2}S_{22})^2)$$

$$R^2 = S_{12}^2((R_{T1} + R_{R1}S_{11})^2 + (R_{T2} + R_{R2}S_{22})^2)$$

$$\text{Noise}^2 = (N_T S_{12})^2 + N_F^2$$

## Sources of Systematic Errors

The residual (after measurement calibration) **systematic errors** result from imperfections in the calibration standards.

For **reflection measurements**, the associated residual errors are:

residual directivity                      residual load match  
residual source match                  residual reflection tracking

For **transmission measurements**, the additional residual errors are:

residual crosstalk                      residual load match  
residual source match                  residual transmission tracking

The listing below shows the **abbreviations** used for residual systematic errors that are in the uncertainty equations.

<b>E<sub>DF</sub></b> = forward residual directivity	<b>E<sub>SR</sub></b> = reverse residual source match
<b>E<sub>SF</sub></b> = forward residual source match	<b>E<sub>RR</sub></b> = reverse residual reflection tracking
<b>E<sub>RF</sub></b> = forward residual reflection tracking	<b>E<sub>XR</sub></b> = reverse crosstalk
<b>E<sub>XF</sub></b> = forward crosstalk	<b>E<sub>LR</sub></b> = reverse load match
<b>E<sub>LF</sub></b> = forward load match	<b>E<sub>TR</sub></b> = reverse transmission tracking
<b>E<sub>TF</sub></b> = forward transmission tracking	<b>A<sub>M</sub></b> = magnitude dynamic accuracy
<b>E<sub>DR</sub></b> = reverse residual directivity	<b>A<sub>P</sub></b> = phase dynamic accuracy

All measurements are affected by **dynamic accuracy**. Dynamic accuracy includes: errors during internal self-calibration routines, gain compression in the microwave frequency converter (sampler) at high signal levels, errors generated in the synchronous detectors, localized non-linearities in the IF filter system, and from LO leakage into the IF signal paths.

## Sources of Random Errors

The **random error** sources are

- noise
- connector repeatability
- interconnecting cable stability

There are two types of noise in any measurement system:

1. low level noise (noise floor)
2. high level noise (trace noise)

**Low level noise** is the broadband noise floor of the receiver which can be reduced through averaging or by changing the IF bandwidth.

**High level noise** or trace noise is due to the noise floor of the receiver, and the phase noise of the LO source inside the test set. It is worsened by reducing the IF bandwidth. Using a high stability 10 MHz time base can reduce high level noise.

A high stability time base is standard with PNA models E8356/7/8A and E8362/3/4A. It is available as Option 1E5 with PNA models E8801/2/3A and N3381/2/3A. Option 1E5 replaces a 10 ppm time base with a 1 ppm time base.

**Connector repeatability** is the random variation encountered when connecting a pair of RF connectors. Variations in both reflection and transmission can be observed.

**Cable stability** is dependent on the cable used and the amount of cable movement between calibration and measurement.

The listing below shows the **abbreviations** used for random errors in the error models and uncertainty equations.

$N_F$  = noise floor

$N_T$  = trace noise

$C_{R1}$  = port 1 cable reflection stability

$C_{TM1}$  = port 1 cable magnitude transmission stability

$C_{TP1}$  = port 1 cable phase transmission stability

$C_{R2}$  = port 2 cable reflection stability

$C_{TM2}$  = port 2 cable magnitude transmission stability

$C_{TP2}$  = port 2 cable phase transmission stability

$R_{R1}$  = port 1 connector reflection repeatability

$R_{T1}$  = port 1 connector transmission repeatability

$R_{R2}$  = port 2 connector reflection repeatability

$R_{T2}$  = port 2 connector transmission repeatability

## Determining Expected System Performance

Improper connection techniques and contact surfaces can degrade measurement accuracy.

Proper connection techniques include using a torque wrench with proper torque limits, ensuring that the connector pin depths meet specifications, ensuring that the center conductor of sliding loads is properly set, and observing proper handling procedures for beadless airlines.

Contact surface errors are caused by improper cleaning procedures, scratches, worn plating, and rough seating.

View more information on connector care

If proper connection techniques and connector care is observed, the following table provides an indication of connector repeatability.

<b>Connector Repeatability (<math>R_{R1}</math>, <math>R_{R2}</math>, <math>R_{T1}</math>, and <math>R_{T2}</math>)</b>			
Connector Type		Connector Type	
Frequency Range	Repeatability	Frequency Range	Repeatability
<b>2.4-mm</b>		<b>3.5-mm</b>	
0 to 2 GHz	0.0002	0 to 2 GHz	0.0001
2 to 20 GHz	0.0004	2 to 8 GHz	0.0003
20 to 36 GHz	0.0006	8 to 20 GHz	0.0006
36 to 40 GHz	0.0008	20 to 26.5 GHz	0.0010
<b>7-mm</b>		<b>Type-N</b>	
0 to 2 GHz	0.0001	0 to 2 GHz	0.0006
2 to 8 GHz	0.0003	2 to 8 GHz	0.0006
8 to 18 GHz	0.0006	8 to 18 GHz	0.0010
<b>Type-F</b>		<b>Waveguide</b>	
0 to 3 GHz	0.0006	0 to 40 GHz	0.0002

## Determining Cable Stability Terms

( $C_{R1}$ ,  $C_{R2}$ ,  $C_{TM1}$ ,  $C_{TM2}$ ,  $C_{TP1}$ ,  $C_{TP2}$ )

Cable stability is dependent on the cable used and the amount of cable movement between calibration and measurement. Values for **cable reflection stability** are determined by connecting a fixed load to the free end of

the cable and measuring the change in reflection coefficient after flexing the cable through the normal range of cable movement for a particular setup. **Cable transmission stability** is determined by connecting a short to the free end of the cable and measuring the change in reflection coefficient due to changes in cable position.

Graphics 1-3 demonstrate concepts useful in determining cable stability. In each case, a cable (part number 8120-4779) was connected to port 1, with a fixed load connected to the free end. A reference trace is obtained by measuring  $S_{11}$  with the free end held close to port 2 and storing the results in memory. Two additional  $S_{11}$  measurements are made; one with the cable flexed out to its straight position and the other with the cable positioned back to the same location as reference trace. As shown in Graphic 1, the flexed position demonstrates the effect of moving the cable after calibration. The repeatability trace demonstrates the stability of the cable when moved to its original position.

**Graphic 1**

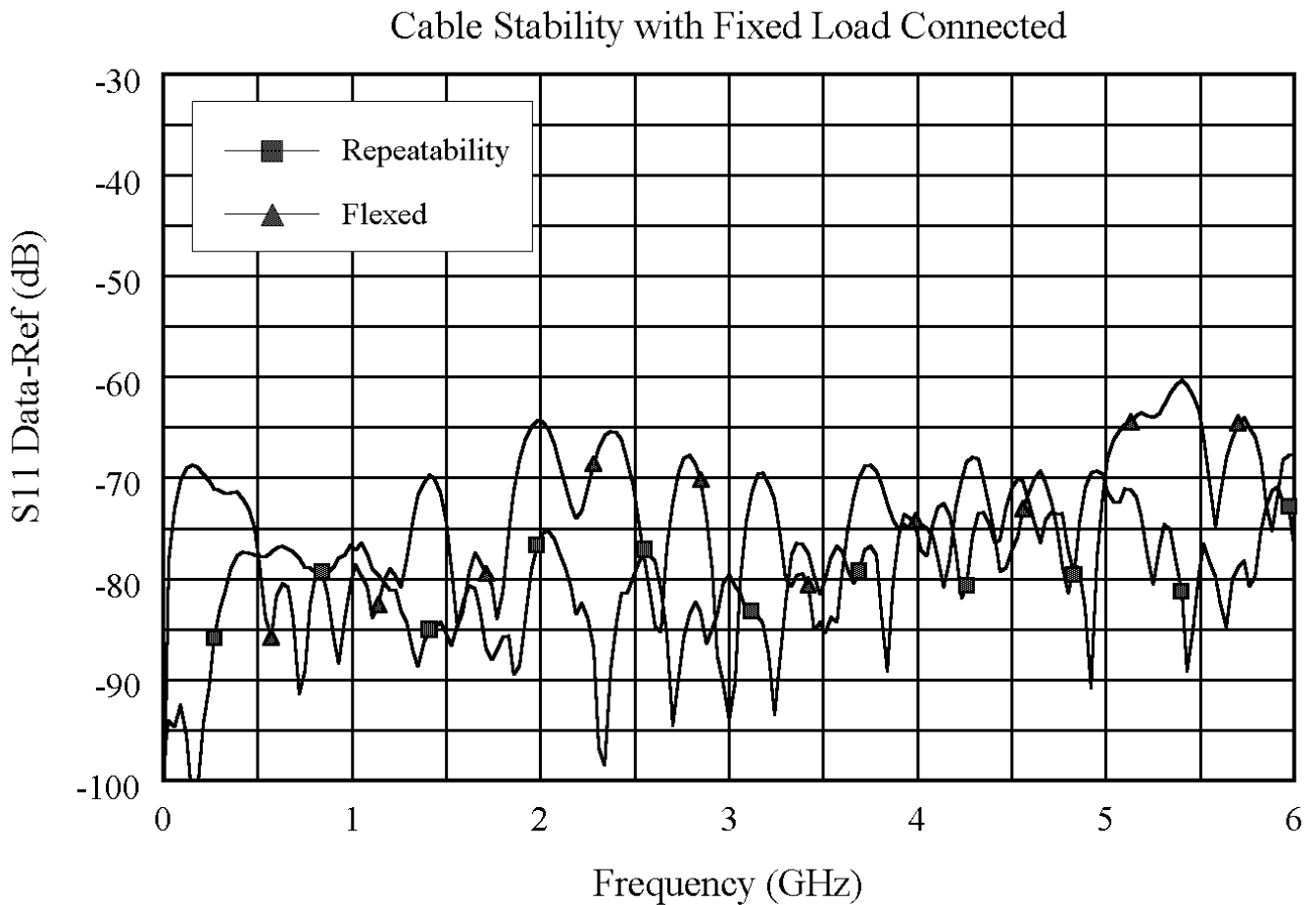

Graphic 1 demonstrates the concepts useful in determining cable reflection stability. A fixed load is connected to the free end. The DATA-MEM feature provides an indication of the cable reflection stability. A 60-dB peak on the chart yields a reflection stability estimated as  $10^{(60/20)}$  or 0.001.

Graphic 2

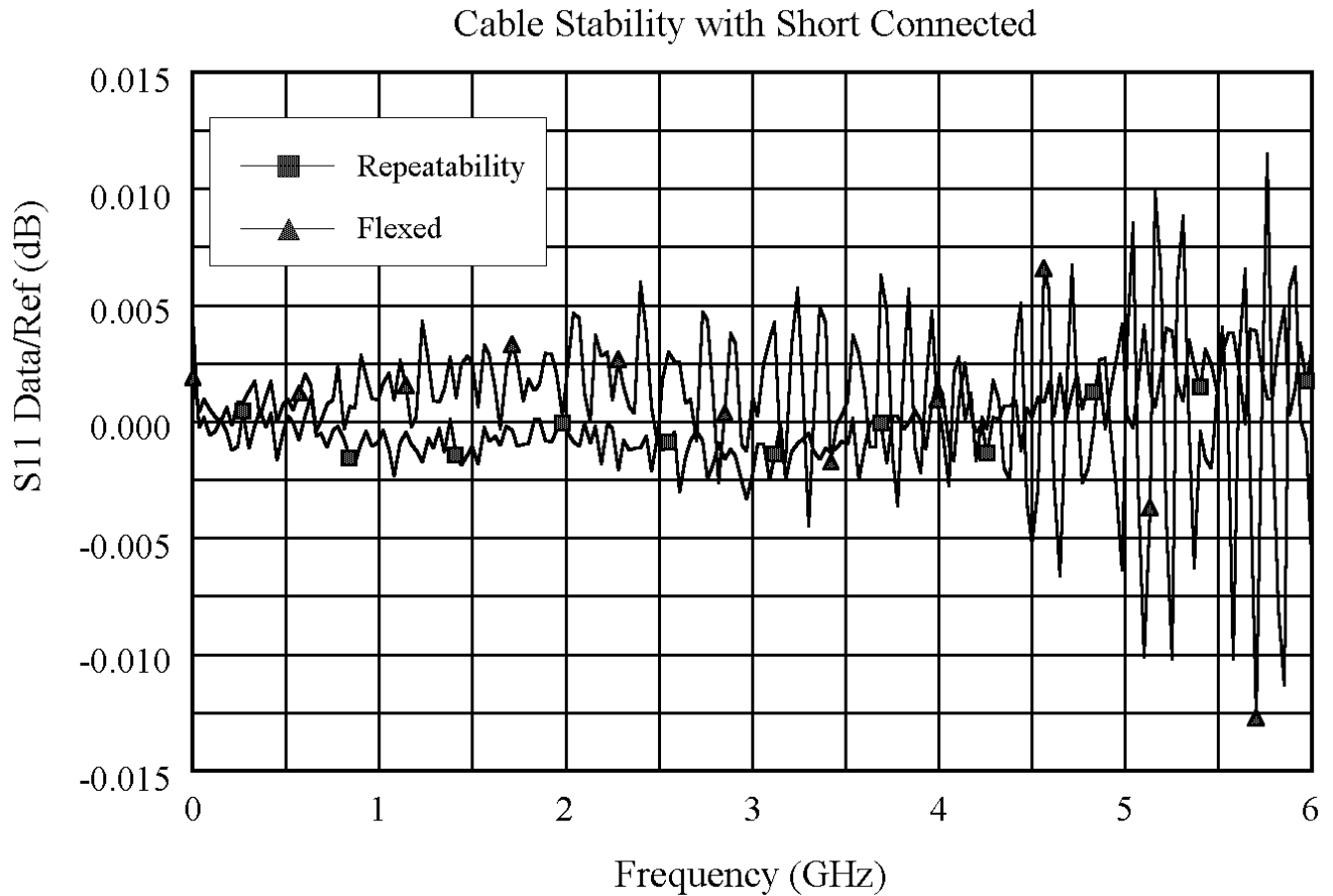

Graphic 2 and Graphic 3 demonstrate the concepts useful in determining cable transmission stability. A short is connected to the free end. The DATA/MEM feature provides an indication of the two-way cable transmission stability. The one-way transmission magnitude stability is determined by dividing the two-way magnitude measurement by two before it is converted to linear. A 0.013-dB peak on the chart yields transmission magnitude stability estimated as  $10^{(0.013/40)}$  or 0.00075. The one-way transmission phase stability is determined by dividing the two-way phase measurement by two.



Graphic 3

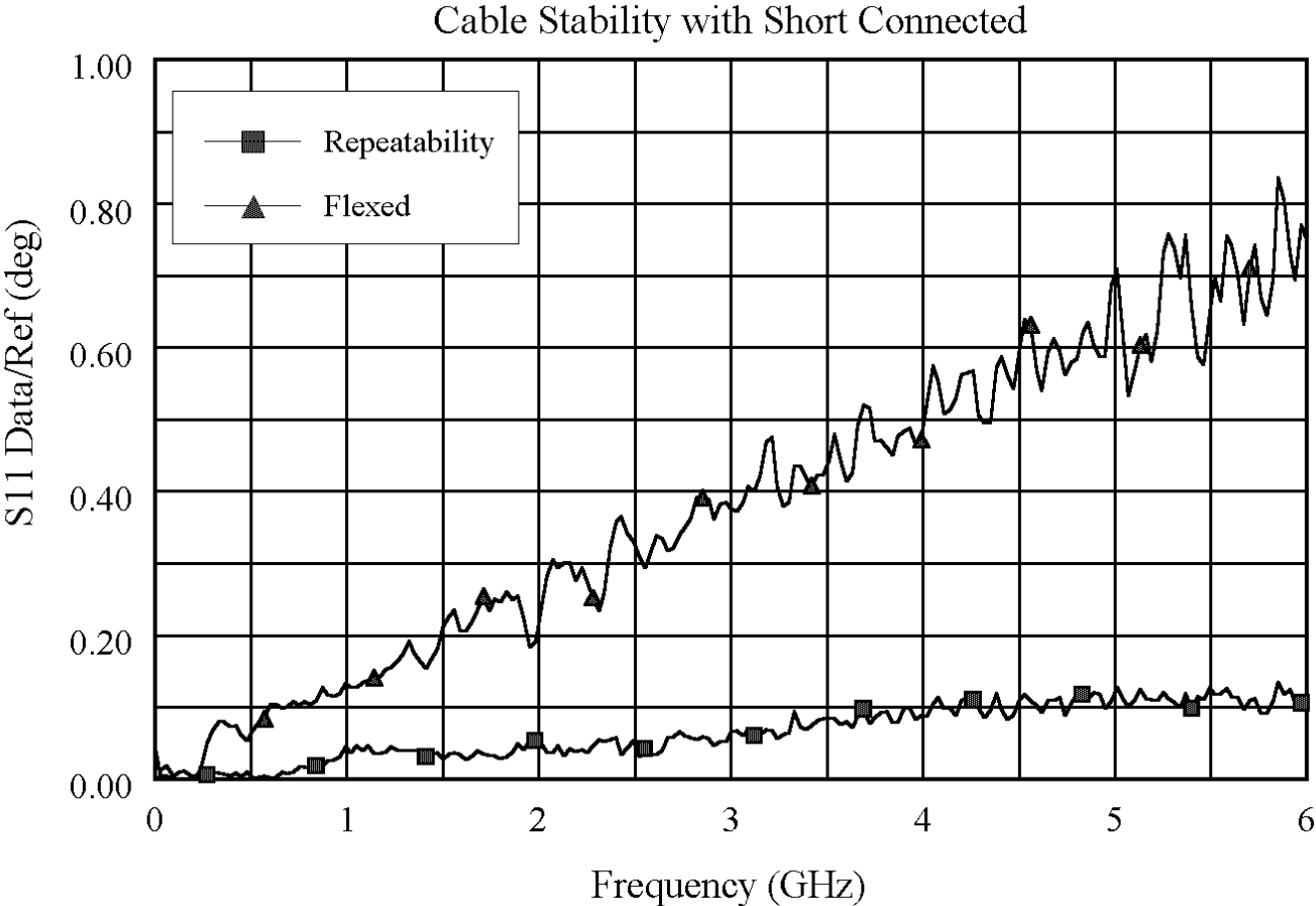

Cable movement often has a much larger effect on phase measurements than magnitude measurements.